



**PRISM MPI2-25 and MPX2-25
SDI / IP Waveform Monitor
User Manual**

Copyrights and Trademark Notices

Copyright © 2023 Telestream, LLC and its Affiliates. All rights reserved. TELESTREAM is a registered trademark of Telestream, LLC. All other trade names referenced are the service marks, trademarks, or registered trademarks of their respective companies.

Telestream products are covered by U.S. and foreign patents, issued and pending. Information in this publication supersedes that in all previously published material. Specifications and price change privileges reserved.

TELESTREAM is a registered trademark of Telestream, LLC.

Blender: Images from Big Buck Bunny used without modification under the Creative Commons Attribution 3.0 license. (c) copyright 2008, Blender Foundation / <http://peach.blender.org/about/>.

Dolby: Dolby and the double-D symbol are registered trademarks of Dolby Laboratories.

Warranty

Telestream on behalf of itself and its Affiliates (“Telestream”) warrants that this product will be free from defects in materials and workmanship for a period of one (1) year from the date of shipment. If any such product proves defective during this warranty period, Telestream, at its option, either will repair the defective product without charge for parts and labor, or will provide a replacement in exchange for the defective product. Parts, modules and replacement products used by Telestream for warranty work may be new or reconditioned to like new performance. All replaced parts, modules and products become the property of Telestream.

In order to obtain service under this warranty, Customer must notify Telestream of the defect before the expiration of the warranty period and make suitable arrangements for the performance of service. Customer shall be responsible for packaging and shipping the defective product to the service center designated by Telestream, with shipping charges prepaid. Telestream shall pay for the return of the product to Customer if the shipment is to a location within the country in which the Telestream service center is located. Customer shall be responsible for paying all shipping charges, duties, taxes, and any other charges for products returned to any other locations.

This warranty shall not apply to any defect, failure or damage caused by improper use or improper or inadequate maintenance and care. Telestream shall not be obligated to furnish service under this warranty a) to repair damage resulting from attempts by personnel other than Telestream representatives to install, repair or service the product; b) to repair damage resulting from improper use or connection to incompatible equipment; c) to repair any damage or malfunction caused by the use of non- Telestream supplies; or d) to service a product that has been modified or integrated with other products when the effect of such modification or integration increases the time or difficulty of servicing the product.

THIS WARRANTY IS GIVEN BY TELESTREAM WITH RESPECT TO THE PRODUCT IN LIEU OF ANY OTHER WARRANTIES, EXPRESS OR IMPLIED. TELESTREAM AND ITS VENDORS

DISCLAIM ANY IMPLIED WARRANTIES OF MERCHANTABILITY OR FITNESS FOR A PARTICULAR PURPOSE. TELESTREAM'S RESPONSIBILITY TO REPAIR OR REPLACE DEFECTIVE PRODUCTS IS THE SOLE AND EXCLUSIVE REMEDY PROVIDED TO THE CUSTOMER FOR BREACH OF THIS WARRANTY. TELESTREAM AND ITS VENDORS WILL NOT BE LIABLE FOR ANY INDIRECT, SPECIAL, INCIDENTAL, OR CONSEQUENTIAL DAMAGES IRRESPECTIVE OF WHETHER TELESTREAM OR THE VENDOR HAS ADVANCE NOTICE OF THE POSSIBILITY OF SUCH DAMAGES.

[W2 – 15AUG04]

TELESTREAM SOFTWARE LICENSE AGREEMENT

THE PROGRAM, OR PROGRAMS, ENCODED OR INCORPORATED WITHIN EQUIPMENT OR ACCOMPANYING THIS AGREEMENT, IS FURNISHED SUBJECT TO THE TERMS AND CONDITIONS OF THIS AGREEMENT. RETENTION OF THE PROGRAM FOR MORE THAN THIRTY DAYS OR USE OF THE PROGRAM IN ANY MANNER WILL BE CONSIDERED ACCEPTANCE OF THE AGREEMENT TERMS. IF THESE TERMS ARE NOT ACCEPTABLE, THE UNUSED PROGRAM AND ANY ACCOMPANYING DOCUMENTATION SHOULD BE RETURNED PROMPTLY TO TELESTREAM FOR A FULL REFUND OF THE LICENSE FEE PAID. (FOR INFORMATION REGARDING THE RETURN OF PROGRAMS ENCODED OR INCORPORATED WITHIN EQUIPMENT, CONTACT THE NEAREST TELESTREAM SALES OFFICE.)

DEFINITIONS

"Telestream" means Telestream, LLC, a Delaware limited liability company, and its Affiliates, or the local Telestream legal entity that is supplying the equipment.

"Program" means the Telestream software product (executable program and/or data) enclosed with this Agreement or included within the equipment with which this Agreement is packed. "Customer" means the person or organization in whose name the Program was ordered.

LICENSE

Customer may:

1. Use the Program on a single machine at any one time; and
2. Copy the Program for archival or backup purposes, provided that no more than one (1) such copy is permitted to exist at any one time. Each copy of the Program made by Customer must include a reproduction of any copyright notice or restrictive rights legend appearing in or on the copy of the Program as received from Telestream.

Customer may not:

1. Use the Program on more than one machine at any one time;
2. Transfer the Program to any person or organization outside of Customer or the corporation of which Customer is a part without the prior written consent of Telestream, except in connection with the transfer of the equipment within which the programs are encoded or incorporated;

3. Export or re-export, directly or indirectly, the program, any associated documentation, or the direct product thereof, to any country to which such export or re-export is restricted by law or regulation of the United States or any foreign government having jurisdiction without the prior authorization, if required, of the Office of Export Administration, Department of Commerce, Washington, D.C. and the corresponding agency of such foreign government;
4. Modify the Program, create derivative works, or merge the Program with another program;
5. Reverse compile or disassemble the Program for any purpose, beyond the extent that such activity is expressly permitted by applicable open source licenses or applicable law notwithstanding this limitation; or
6. Copy the documentation accompanying the Program.

For Programs designed to reside on a single-machine and support one or more additional machines, either locally or remotely, without permitting the Program to be transferred to an additional machine for local execution, the additional machines shall be considered within the definition of "single machine." For programs permitting the Program to be transferred to an additional machine for local execution, a separate license shall be required for each such machine with which the Program may be used. Title to the Program and all copies thereof, but not the media on which the Program or copies may reside, shall be and remain with Telestream or others for whom Telestream has obtained a respective licensing right. Customer shall pay when due all property taxes that may now or hereafter be imposed, levied or assessed with respect to the possession or use of the Program or this license and shall file all reports required in connection with such taxes. If the Program or any related documentation is acquired by or for an agency of the U.S. Government, the Program and documentation shall be considered "commercial computer software" or "commercial computer software documentation" respectively, as those terms are used in 48 CFR §12.212, 48 CFR §227.7202, or 48 CFR §252.227-7014, and are licensed with only those rights as are granted to all other licensees as set forth in this Agreement.

THE PROGRAM MAY NOT BE USED, COPIED, MODIFIED, MERGED, OR TRANSFERRED TO ANOTHER EXCEPT AS EXPRESSLY PERMITTED BY THESE TERMS AND CONDITIONS. UPON TRANSFER OF ANY COPY, MODIFICATION, OR MERGED PORTION OF THE PROGRAM, THE LICENSE GRANTED HEREIN IS AUTOMATICALLY TERMINATED WITH RESPECT TO THE PARTY THAT TRANSFERS THE PROGRAM.

TERM

The license granted herein is effective upon acceptance by Customer, and shall remain in effect until terminated as provided herein. The license may be terminated by Customer at any time upon written notice to Telestream. The license may be terminated by Telestream or any third party from whom Telestream may have obtained a respective licensing right if Customer fails to comply with any term or condition and such failure is not remedied within thirty (30) days after notice hereof from Telestream or such third party. Upon termination by either party, Customer shall return to Telestream or destroy, the Program and all associated documentation, together with all copies in any form.

LIMITED WARRANTY

The Program is provided "as is" without warranty of any kind, either express or implied. Telestream does not warrant that the functions contained in the Program will meet Customer's requirements or that the operation of the Program will be uninterrupted or error-free.

TELESTREAM AND ITS VENDORS DISCLAIM ANY IMPLIED WARRANTIES OF MERCHANTABILITY OR FITNESS FOR A PARTICULAR PURPOSE. LIMITATION OF LIABILITY, IN NO EVENT SHALL TELESTREAM OR OTHERS FROM WHOM TELESTREAM HAS OBTAINED A LICENSING RIGHT BE LIABLE FOR ANY INDIRECT, SPECIAL, INCIDENTAL, OR CONSEQUENTIAL DAMAGES ARISING OUT OF OR CONNECTED WITH CUSTOMER'S POSSESSION OR USE OF THE PROGRAM, EVEN IF TELESTREAM OR SUCH OTHERS HAS ADVANCE NOTICE OF THE POSSIBILITY OF SUCH DAMAGES.

THIRD-PARTY DISCLAIMER

Except as expressly agreed otherwise, third parties from whom Telestream may have obtained a licensing right do not warrant the program, do not assume any liability with respect to its use, and do not undertake to furnish any support or information relating thereto.

GENERAL

This Agreement contains the entire agreement between the parties with respect to the use, reproduction, and transfer of the Program. Neither this Agreement nor the license granted herein is assignable or transferable by Customer without the prior written consent of Telestream. This Agreement and the license granted herein shall be governed by the laws of the state of California. All questions regarding this Agreement or the license granted herein should be directed to the nearest Telestream Sales Office.

Contents

Important Compliance and Safety Information 9

Preface 19

Getting Started 22

- Product Description 23
- Rack Mounting 29
- MPI2-25 Power-on and Power-off Procedures 31
- MPX2-25 Power-on and Power-off Procedures 34
- SFP Module Installation 36
- Network Installation 37
- MPI2-25 Rear Connectors 39
- MPX2-25 Rear Panel Connectors 43
- Display Elements 46

Methods of Operation 53

- Touchscreen Operation 54
- Select and Organize Applications 56
- On-screen Tools 61
- Keyboard and Mouse Operation 62
- MPX2-25 Front-panel Controls 64
- Display Operation 66
- Remote Control Operation 71

Configure the Instrument 79

- Configure and Select Virtual Inputs 80
- Configure Instrument for HDR/WCG Monitoring 132
- Enable NMOS 134
- Adjust Audio Settings 137
- Configure Instrument Outputs 141
- Configure to Decode Timecode 143

Configure Reference Settings	145
Set and Recall Instrument Presets	148
Set Syslog Setup	160
SNMP Functionality	161
Alarms	164
Adjust Display	174
Set Time and Date	182
Upgrade Instrument Firmware	185
Upgrade Software License	188
Troubleshooting	189

Functions 191

Headphone or Speaker Volume, Balance, Device, and Source Adjustment	192
Capture	196

Application Information 199

Application Options	200
Waveform Application	206
Vector Application	218
Lightning Application	226
Diamond Application	234
CIE Application	241
Stop Display Application	244
CAM Application	253
Picture Application	263
Video Session Application	279
Audio Application	284
Dolby Status Application	306
AES Channel Status Application	313
Event Log Application	314
IP Status Application	322
IP Session Application	326
IP Graphs Application	341
PIT Histogram Application	347
PTP Graphs Application	350
Stream Timing Application	353
ANC (Ancillary Data) Session Application	359
Datalist Application	362
Timing Application	364
Eye Application	368
Jitter Application	370
Audio-Video Delay Application	372
IP Generator Application	376
SDI Generator Application	384

PTP Operational Overview 387

PTP Introduction **388**

Five Basic PTP Timing Messages **388**

Profiles and Domains **391**

One-step and Two-step Operation **392**

Multicast, Unicast, and Mixed Communication Modes **393**

BMCA Operation **395**

Compensating for Causes of Asymmetric Delay **396**

NMOS Specifications 398

Important Compliance and Safety Information

United States of America Compliance Notices

Class A Interference Statement

This equipment has been tested and found to comply with the limits for a Class A digital device, pursuant to Part 15, Subpart B of the FCC Rules. These limits are designed to provide reasonable protection against harmful interference in a commercial installation. This equipment generates, uses, and can radiate radio frequency energy and, if not installed and used in accordance with the instructions, may cause harmful interference to radio communications. However, there is no guarantee that interference will not occur in a particular installation. Operation of this equipment in a residential area is likely to cause harmful interference in which case the user will be required to correct the interference at his own expense.

FCC Caution

This device complies with Part 15 of the FCC Rules. Operation is subject to the following two conditions:

1. This device may not cause harmful interference, and
2. This device must accept any interference received, including interference that may cause undesired operation.

Safety

UL 61010-1: 2012 R7.19: Safety Requirements for Electrical Equipment for Measurement, Control, and Laboratory Use - Part 1: General Requirements.

Environmental

Perchlorate Materials: this product contains one or more type CR lithium batteries. According to the state of California, CR lithium batteries are classified as perchlorate materials and require special handling.

See www.dtsc.ca.gov/hazardouswaste/perchlorate for additional information.

Canada Compliance Notices

Department of Communications Radio Interference Regulations

This digital apparatus does not exceed the Class A limits for radio-noise emissions from a digital apparatus as set out in the Radio Interference Regulations of the Canadian Department of Communications. This Class A digital apparatus complies with Canadian ICES-003.

Règlement sur le brouillage radioélectrique du Quadstere des Communications

Cet appareil numérique respecte les limites de bruits radioélectriques visant les appareils numériques de classe A prescrites dans le Règlement sur le brouillage radioélectrique du Quadstere des Communications du Canada. Cet appareil numérique de la Classe A est conforme à la norme NMB-003 du Canada.

Safety

CAN/CSA-C22.2 NO. 61010-1-12 + G11 + G12 (R2017) + A1: Safety Requirements for Electrical Equipment for Measurement, Control, and Laboratory Use - Part 1: General Requirements.

Sécurité

CAN/CSA-C22.2 NO. 61010-1-12 + G11 + G12 (R2017) + A1: Exigences de sécurité pour l'électricité Matériel de mesure, de contrôle et d'utilisation en laboratoire - Partie 1: Généralités Exigences.

European Union, European Free Trade Association (EFTA), and United Kingdom Compliance Notices

This equipment may be operated in the countries that comprise the member countries of the European Union and the European Free Trade Association. These countries, listed in the following paragraph, are referred to as The European Community throughout this document:

AUSTRIA, BELGIUM, BULGARIA, CYPRUS, CROATIA, CZECHIA, DENMARK, ESTONIA, FINLAND, FRANCE, GERMANY, GREECE, HUNGARY, IRELAND, ITALY, LATVIA, LITHUANIA, LUXEMBOURG, MALTA, NETHERLANDS, POLAND, PORTUGAL, ROMANIA, SLOVAKIA, SLOVENIA, SPAIN, SWEDEN, UNITED KINGDOM, ICELAND, LICHTENSTEIN, NORWAY, SWITZERLAND

Declaration of Conformity

Marking by the "CE" symbol indicates compliance with the Essential Requirements of the EMC Directive of the European Union 2014/30/EU

This equipment meets the following conformance standards:

Safety

EN 61010-1: 2010 + A1: Safety Requirements for Electrical Equipment for Measurement, Control, and Laboratory Use - Part 1: General Requirements Low Voltage Directive 2014/35/EU

Emissions

EN 55032: 2015 + A11: 2020, CISPR 32: 2015, EN 61000-3-2: 2014, EN 61000-3-3: 2013

Immunity

EN 55035: 2017, EN 61000-4-2: 2009,

EN 61000-4-3: 2006 + A1: 2008 + A2: 2010, EN 61000-4-4: 2012,

EN 61000-4-5: 2014 + A1: 2017, EN 61000-4-6: 2014, EN 61000-4-8: 2010,

EN 61000-4-11: 2020

Environments: E2

Warnings



Warning! This is a Class A product. In a domestic environment, this product may cause radio interference, in which case, the user may be required to take appropriate measures.



Achtung! Dieses ist ein Gerat der Funkstorgrenzwertklasse A. In Wohnbereichen können bei Betrieb dieses Gerates Rundfunkstörungen auftreten, in welchen Fallen der Benutzer für entsprechende Gegenmaßnahmen verantwortlich ist.



Attention! Ceci est un produit de Classe A. Dans un environnement domestique, ce produit risque de créer des interférences radioélectriques, il appartiendra alors à l'utilisateur de prendre les mesures spécifiques appropriées.

Notes:

1. For Compliance with the EMC standards listed here, high quality shielded interface cables should be used.
2. Emissions which exceed the levels required by this standard may occur when this equipment is connected to a test object.

Environmental Compliance

This section provides information about the environmental impact of the product.

Product end-of-life handling

Observe the following guidelines when recycling an instrument or component:

Equipment recycling



Production of this equipment required the extraction and use of natural resources. The equipment may contain substances that could be harmful to the environment or human health if improperly handled at the product's end of life. To avoid release of such substances into the environment and to reduce the use of natural resources, we

encourage you to recycle this product in an appropriate system that will ensure that most of the materials are reused or recycled appropriately.

This symbol on the product or its packaging indicates that this product complies with the applicable European Union requirements according to Directives 2012/19/EU and 2006/66/EC on waste electrical and electronic - equipment (WEEE) and batteries.

It also indicates that this product must not be disposed of with your other household waste. Instead, it is your responsibility to dispose of your waste equipment by handing it over to a designated collection point for the recycling of waste electrical and electronic equipment. The separate collection and recycling of your waste equipment at the time of disposal will help conserve natural resources and ensure that it is recycled in a manner that protects human health and the environment. For more information about where you can drop off your waste for recycling, please contact your local authority, or where you purchased your product.

Battery Recycling

This product may contain a rechargeable battery, which must be recycled or disposed of properly. Please properly dispose of or recycle the battery according to local government regulations.

Transporting Batteries or products with Batteries in them

The capacity of the lithium ion secondary battery shipped with this product is under 100 Wh. The lithium content of the installed primary battery is under 1 g. Each battery meets the applicable requirements of UN Manual of Tests and Criteria Part III Section 38.3. Battery quantity is under the limit for shipment according to Section II of the relevant Packing Instructions from the IATA Dangerous Goods Regulations. Consult your air carrier for applicability and determination of any special lithium battery transportation requirements.

Restriction of Hazardous Substances

This product is classified as an industrial monitoring and control instrument, and is required to comply with the substance restrictions of the RoHS 3 Directives 2011/65/EU and EU 2015/863.

Korea Compliance Statement

사 용 자 안 내 문
이 기기는 업무용 환경에서 사용할 목적으로 적합성평가를 받은 기기로서 가정용 환경에서 사용하는 경우 전파간섭의 우려가 있습니다.

Taiwan Compliance Statement

警告使用者：
這是甲類的資訊產品，在居住的環境中使用時，可能會造成射頻干擾，在這種情況下，使用者會被要求採取某些適當的對策。

This is a Class A product based on the standard of the Bureau of Standards, Metrology and Inspection (BSMI) CNS 13438, Class A. In a domestic environment this product may cause radio interference, in which case the user may be required to take adequate measures.

Japan Compliance Statement

この装置は、クラスA情報技術装置です。この装置を家庭環境で使用すると電波妨害を引き起こすことがあります。この場合には使用者が適切な対策を講ずるよう要求されることがあります。 VCCI-A

This is a Class A product based on the standard of the VCCI Council (VCCI 32: 2016). If this equipment is used in a domestic environment, radio interference may occur, in which case the user may be required to take corrective actions.

Important Safety Information

This manual contains information and warnings that must be followed by the user for safe operation and to keep the product in a safe condition. To safely perform service on this product, see the Service safety summary that follows the General safety summary.

General Safety Summary

Use the product only as specified. Review the following safety precautions to avoid injury and prevent damage to this product or any products connected to it. Carefully read all instructions. Retain these instructions for future reference.

Comply with Local and National Safety Codes

For correct and safe operation of the product, it is essential that you follow generally accepted safety procedures in addition to the safety precautions specified in this manual.

Product is Designed to be Used by Trained Personnel Only

Only qualified personnel who are aware of the hazards involved should remove the cover for repair, maintenance, or adjustment. Before use, always check the product with a known source to be sure it is operating correctly.

While using this product, you may need to access other parts of a larger system. Read the safety sections of the other component manuals for warnings and cautions related to operating the system.

When incorporating this equipment into a system, the safety of that system is the responsibility of the assembler of the system.

To Avoid Fire or Personal Injury

Use proper power cord: Use only the power cord specified for this product and certified for the country of use. Do not use the provided power cord for other products.

Ground the product: This product is grounded through the grounding conductor of the power cord. To avoid electric shock, the grounding conductor must be connected to earth ground. Before making connections to the input or output terminals of the product, ensure that the product is properly grounded. Do not disable the power cord grounding connection.

Power disconnect: The power cord disconnects the product from the power source. See instructions for the location. Do not position the equipment so that it is difficult to operate the power cord; it must remain accessible to the user at all times to allow for quick disconnection if needed.

Observe all terminal ratings: To avoid fire or shock hazard, observe all rating and markings on the product. Consult the product manual for further ratings information before making connections to the product. Do not apply a potential to any terminal, including the common terminal, that exceeds the maximum rating of that terminal.

Do not operate without covers: Do not operate this product with covers or panels removed, or with the case open. Hazardous voltage exposure is possible.

Avoid exposed circuitry: Do not touch exposed connections and components when power is present.

Do not operate with suspected failures: If you suspect that there is damage to this product, have it inspected by qualified service personnel.

Disable the product if it is damaged. Do not use the product if it is damaged or operates incorrectly. If in doubt about safety of the product, turn it off and disconnect the power cord. Clearly mark the product to prevent its further operation.

Before use, inspect voltage probes, test leads, and accessories for mechanical damage and replace when damaged. Do not use probes or test leads if they are damaged, if there is exposed metal, or if a wear indicator shows.

Examine the exterior of the product before you use it. Look for cracks or missing pieces.

Use Only Specified Replacement Parts

Do not operate in wet/damp conditions: Be aware that condensation may occur if a unit is moved from a cold to a warm environment.

Do not operate in an explosive atmosphere.

Keep product surfaces clean and dry: Remove the input signals before you clean the product.

Provide proper ventilation: Refer to the manual's installation instructions for details on installing the product so it has proper ventilation.

Slots and openings are provided for ventilation and should never be covered or otherwise obstructed. Do not push objects into any of the openings.

Provide a safe working environment: Always place the product in a location convenient for viewing the display and indicators.

Be sure your work area meets applicable ergonomic standards. Consult with an ergonomics professional to avoid stress injuries.

Use only the Telestream rackmount hardware specified for this product.

Service Safety Summary

The Service safety summary section contains additional information required to safely perform service on the product. Only qualified personnel should perform service procedures. Read this Service safety summary and the General safety summary before performing any service procedures.

To avoid electric shock: Do not touch exposed connections.

Do not service alone: Do not perform internal service or adjustments of this product unless another person capable of rendering first aid and resuscitation is present.

Disconnect power: To avoid electric shock, switch off the product power and disconnect the power cord from the mains power before removing any covers or panels, or opening the case for servicing.

Use care when servicing with power on: Dangerous voltages or currents may exist in this product. Disconnect power, remove battery (if applicable), and disconnect test leads before removing protective panels, soldering, or replacing components.

Verify safety after repair: Always recheck ground continuity and mains dielectric strength after performing a repair.

Terms in the Manual

These terms may appear in this manual:



WARNING: Warning statements identify conditions or practices that could result in injury or loss of life.



CAUTION: Caution statements identify conditions or practices that could result in damage to this product or other property.

Terms on the Product

These terms may appear on the product:

DANGER indicates an injury hazard immediately accessible as you read the marking.

WARNING indicates an injury hazard not immediately accessible as you read the marking.

CAUTION indicates a hazard to property including the product.

Symbols on the Product

When this symbol is marked on the product, be sure to consult the manual to find out the nature of the potential hazards and any actions which have to be taken to avoid them. (This symbol may also be used to refer the user to ratings in the manual.)

The following symbol(s) may appear on the product:



General Safety Product Specific Statements

Use the product only as specified. Review the following safety precautions to avoid injury and prevent damage to this product or any products connected to it.

Carefully read all instructions. Retain these instructions for future reference.

Comply with local and national safety codes.

For correct and safe operation of the product, it is essential that you follow generally accepted safety procedures in addition to the safety precautions specified in this manual. The product is designed to be used by trained personnel only.

Only qualified personnel who are aware of the hazards involved should remove the cover for repair, maintenance, or adjustment.

Before use, always check the product with a known source to be sure it is operating correctly.

This product is not intended for detection of hazardous voltages.

Use personal protective equipment to prevent shock and arc blast injury where hazardous live conductors are exposed.

When incorporating this equipment into a system, the safety of that system is the responsibility of the assembler of the system.



WARNING: To avoid damaging your hearing, always turn the volume down to the minimum before you put on headphones and then turn the volume up slowly.



CAUTION: To reduce risk of fire and shock, use the certified power cord provided with the product.



CAUTION: To minimize the risk of damage to the instrument, we strongly recommend that the power cord be connected to the instrument before the power cord is connected to the AC power source



CAUTION: To prevent data loss, we strongly recommend you first shut down the instrument before disconnecting the power cord. Press the power button or select Settings, Utilities, Power, and then Power Down Now.



CAUTION: To prevent static damage to the SFP module, if you remove the SFP module from the instrument, always transport the SFP module in an anti-static bag or container.



CAUTION: To prevent possible damage to the PRISM monitor and SFP modules, remove the SFP modules before transporting the PRISM monitor.



CAUTION: After the instrument has started the upgrade process, DO NOT remove power from the instrument. If you do so, the instrument flash will be corrupted. The instrument will have to be sent to a Telestream factory service center to have the system firmware restored.



CAUTION: To prevent damage to the power cord or to the instrument power connector, do not attempt to disconnect the power cord by pulling on the cable. You must press the latch on the plug body, to disengage the locking mechanism, and pull the plug at the same time.



CAUTION: Uploading presets overwrites all existing presets in the PRISM.



CAUTION: Uploading presets overwrites all existing presets in the PRISM uploading the presets.



CAUTION: Removing the USB device or powering off the instrument before the upgrade is complete can cause upgrade failure. To prevent upgrade failure, wait until the Installation Complete message box is displayed before performing these actions.



CAUTION: IGMP communications can fail when the Video IP Ports are configured for the same IP Address.



CAUTION: Remote connectivity can be lost when the control port and either video port are on the same subnet. It is possible to lose remote connectivity while working locally and not know the connectivity was lost. For details on this problem and how to avoid it, see [Connect with VNC Client](#).

Preface

This manual contains information to help you use the PRISM SDI / IP Waveform Monitor:

- How to operate the instrument using the front panel, external mouse, keyboard, display, or remote connection.
- How to use the various applications for monitoring SDI or IP video signals.
- How to configure the instrument for network and remote access.
- How to set up error logging and alarms.

Where to Find More Information

The full User Manual, Release Notes, and other information about your product are available for download at www.telestream.net/video/resources.htm. The Product documentation table lists all the documentation for the PRISM SDI / IP Waveform Monitor.

Product documentation

Document	Manual type	Part number	Description
User Manual	Primary User	D00010019x	Provides detailed operating information.
Release Notes	Release Notes	D00010030x	Describes the new features, improvements, and limitations of the instrument firmware.
Installation and Safety Instructions	User	071373000x	Describes how to install a PRISM MPI2-25 instrument and provides basic safety and operating information (included with instrument).
	User	071373800x	Describes how to install a PRISM MPX2-25 instrument and provides basic safety and operating information (included with instrument).
PRISM MPI Dual Rack Cabinet Version 2 Installation Instructions	Field Install Instructions	071372500x	Describes how to install an MPI instrument in a 19" equipment rack using the optional MPI-RACK-MM or MPI-RACK-MW dual rack cabinet.

Product documentation

Document	Manual type	Part number	Description
Rackmount Slides and Rails Installation Instructions	Field Install Instructions	071370600x	Describes how to install an MPX instrument in a 19" equipment rack
PRISM MPI2-RACK-MD Installation and Safety Instructions	Field Install Instructions	071372800x	Provides installation and safety information for the PRISM MPI2-RACK-MD Rack Cabinet with touch display.
PRISM MPX2-DUALDSP Installation and Safety Instructions	Field Install Instructions	071372900x	Provides installation and safety information for the PRISM MPX2-DUALDSP Dual Display module.

Conventions Used in This Manual

The PRISM SDI / IP Waveform Monitor is also referred to as the "PRISM monitor" throughout this manual.

Telestream Contact Information

To obtain product information, technical support, or provide comments on this guide, contact us using our website, email, or phone number as listed below.

Resource	Contact Information
Telestream Video Support	Website: http://www.telestream.net/telestream-support Email: videosupport@telestream.net US and Canada Toll-free: 1-844-219-5329 Outside of US and Canada: 1-503-967-9833
Telestream	Website: www.telestream.net Sales and Marketing Email: info@telestream.net Telestream 848 Gold Flat Road, Suite 1 Nevada City, CA. USA 95959

Resource	Contact Information
International Distributor Support	Website: www.telestream.net See the Telestream website for your regional authorized Telestream distributor.
Telestream Technical Writers	Email: techwriter@telestream.net If you have comments or suggestions about improving this document, or other Telestream documents—or if you've discovered an error or omission, please email us.

Getting Started

This section helps you set up and begin to use the PRISM SDI / IP Waveform Monitor. It is divided into subsections:

Product description describes your instrument and provides a list of key features.

Controls and connectors shows you how to verify that you have received all of the parts of your instrument and provides a list of standard and optional accessories and a list of options that are available for your instrument.

Network installation shows you how to set up your instrument on an Ethernet network.

Product Description

The PRISM SDI / IP Waveform Monitor provides flexible options and field-installable upgrades to monitor a diverse variety of SDI and IP statistics as well as video and audio content. The comprehensive feature set, along with an intuitive and simplified graphical presentation of IP statistics, including video quality and diagnostic information, enables engineers to ensure the delivery of superior QoS levels in an increasingly complex broadcast environment involving compressed / uncompressed video transmission through SDI/IP signal paths. PRISM is an ideal solution for monitoring SDI/IP hybrid environments including master control rooms, production studios, OB vans, and signal contribution/distribution centers.

PRISM Model Form Factors

The PRISM SDI / IP Waveform Monitor is available in two form factors:

MPI2-25

The PRISM MPI2-25 is 3RU half-rack width with integrated 9-inch HD display and touch panel. Option PHY is available to add physical layer measurement sets.



MPX2-25

The PRISM MPX2-25 is 1RU full-rack width with optional integrated speakers. The MPX2-25 requires an external monitor or a remote connection, such as VNC. Option PHY is available to add physical layer measurement sets. Option RACK is required for rack mount.



Supported Formats

Supported SDI formats

Link	Format	Sample Structure	Bits	Frame/field rate	Option	
SD-SDI	525i	4:2:2	YCbCr	10b	59.94i	Base instrument
	625i	4:2:2	YCbCr	10b	50i	Base instrument
HD-SDI	1280x720	4:2:2	YCbCr	10b	23.98/24/25/ 29.97/30/50/ 59.94/60p	Base instrument
	1920x1080	4:2:2	YCbCr	10b	50/59.94/60i, 23.98/24/25/ 29.97/30p and psF	Base instrument
	2048x1080	4:2:2	YCbCr	10b	23.98/24/25/ 29.97/30p and psF	Base instrument
3G-SDI Level A	1920x1080	4:2:2	YCbCr	10b	50/59.94/60p	Base instrument
	1920x1080	4:4:4	RGB	10/12b	23.98/24/25/ 29.97/30p	MP2-PROD
	2048x1080	4:2:2	YCbCr	10b	47.95/48/50/ 59.94/60p	Base instrument
	2048x1080	4:4:4	RGB	10/12b	23.98/24/25/ 29.97/30p	MP2-PROD
3G-SDI Level B	1920x1080	4:2:2	YCbCr	10b	50/59.94/60p	Base instrument
	1920x1080	4:4:4	RGB	10/12b	23.98/24/25/ 29.97/30p	MP2-PROD
	2048x1080	4:2:2	YCbCr	10b	47.95/48/50/ 59.94/60p	Base instrument
	2048x1080	4:4:4	RGB	12b	23.98/24/25/ 29.97/30p	MP2-PROD
Quad Link HD-SDI Square Division	3840x2160	4:2:2	YCbCr	10b	23.98/24/25/ 29.97/30p, and psF	MP2-FMT-4K
	4096x2160	4:2:2	YCbCr	10b	23.98/24/25/ 29.97/30p	MP2-FMT-4K

Supported SDI formats

Link	Format	Sample Structure	Bits	Frame/field rate	Option	
Quad Link 3G-SDI Level A, Square Division	3840x2160	4:2:2	YCbCr	10b	50/59.94/60p	MP2-FMT-4K
	3840x2160	4:4:4	RGB	10/12b	23.98/24/25/ 29.97/30p	MP2-FMT-4K and MP2-PROD
	4096x2160	4:2:2	YCbCr	10b	47.95/48/50/ 59.94/60p	MP2-FMT-4K
	4096x2160	4:4:4	RGB	10/12b	23.98/24/25/ 29.97/30p	MP2-FMT-4K and MP2-PROD
Quad Link 3G-SDI Level B, Square Division	3840x2160	4:2:2	YCbCr	10b	50/59.94/60p	MP2-FMT-4K
	3840x2160	4:4:4	RGB	10/12b	23.98/24/25/ 29.97/30p	MP2-FMT-4K and MP2-PROD
	4096x2160	4:2:2	YCbCr	10b	47.95/48/50/ 59.94/60p	MP2-FMT-4K
	4096x2160	4:4:4	RGB	10/12b	23.98/24/25/ 29.97/30p	MP2-FMT-4K and MP2-PROD
Quad Link 3G-SDI Level A, Two Sample Interleave	3840x2160	4:2:2	YCbCr	10b	50/59.94/60p	MP2-FMT-4K
	3840x2160	4:4:4	RGB	10/12b	23.98/24/25/ 29.97/30p	MP2-FMT-4K and MP2-PROD
	4096x2160	4:2:2	YCbCr	10b	47.95/48/50/ 59.94/60p	MP2-FMT-4K
	4096x2160	4:4:4	RGB	10/12b	23.98/24/25/ 29.97/30p	MP2-FMT-4K and MP2-PROD
Quad Link 3G-SDI Level B, Two Sample Interleave	3840x2160	4:2:2	YCbCr	10b	50/59.94/60p	MP2-FMT-4K
	3840x2160	4:4:4	RGB	10/12b	23.98/24/25/ 29.97/30p	MP2-FMT-4K and MP2-PROD
	4096x2160	4:2:2	YCbCr	10b	47.95/48/50/ 59.94/60p	MP2-FMT-4K
	4096x2160	4:4:4	RGB	10/12b	23.98/24/25/ 29.97/30p	MP2-FMT-4K and MP2-PROD
6G-SDI	3840x2160	4:2:2	YCbCr	10b	23.98/24/25/ 29.97/30p	MP2-FMT-4K
	4096x2160	4:2:2	YCbCr	10b	23.98/24/25/ 29.97/30p	MP2-FMT-4K

Supported SDI formats

Link	Format	Sample Structure	Bits	Frame/field rate	Option	
12G-SDI	3840x2160	4:2:2	YCbCr	10b	50/59.94/60p	MP2-FMT-4K
	3840x2160	4:4:4	RGB	10/12b	23.98/24/25/ 29.97/30p	MP2-FMT-4K and MP2-PROD
	4096x2160	4:2:2	YCbCr	10b	47.95/48/50/ 59.94/60p	MP2-FMT-4K
	4096x2160	4:4:4	RGB	10/12b	23.98/24/25/ 29.97/30p	MP2-FMT-4K and MP2-PROD
Quad Link 12G-SDI	7680x4320	4:2:2	YCbCr	10b	50/59.94/60p	MP2-FMT-8K

Supported video formats in ST 2022-6 streams

Link	Format	Sample Structure	Bits	Frame/field rate	Option	
SD-SDI	525i	4:2:2	YCbCr	10b	59.94i	Base instrument
	625i	4:2:2	YCbCr	10b	50i	Base instrument
HD-SDI	1280x720	4:2:2	YCbCr	10b	23.98/24/25/29.97/30/50/59.94/ 60p	Base instrument
	1920x1080	4:2:2	YCbCr	10b	50/59.94/60i 23.98/24/25/29.97/30p, and psF	Base instrument
3G-SDI Level A	1920x1080	4:2:2	YCbCr	10b	50/59.94/60p	Base instrument
3G-SDI Level B	1920x1080	4:2:2	YCbCr	10b	50/59.94/60p	Base instrument

Supported video formats in ST 2110-20 streams

Link	Format	Sample Structure	Bits	Frame/field rate	Option
2110-20	525i	4:2:2 YCbCr	10b	59.94i	Base instrument
	625i	4:2:2 YCbCr	10b	50i	Base instrument
	1280x720	4:2:2 YCbCr	10b	23.98/24/25/29.97/30/50/ 59.94/60p	Base instrument
	1920x1080	4:2:2 YCbCr	10b	50/59.94/60i	Base instrument
	1920x1080	4:2:2 YCbCr	10b	23.98/24/25/29.97/30/50/ 59.94/60p	Base instrument
	1920x1080	4:4:4 RGB	12b	23.98/24/25/29.97/30/50/ 59.94/60p	MP2-PROD
	2048x1080	4:2:2 YCbCr	10b	23.98/24/25/29.97/30/50/ 59.94/60p	Base instrument
	2048x1080	4:4:4 RGB	12b	23.98/24/25/29.97/30/50/ 59.94/60p	MP2-PROD
	3840x2160	4:2:2 YCbCr	10b	23.98/24/25/29.97/30/50p	MP2-FMT-4K
	3840x2160	4:2:2 YCbCr	10b	59.94/60p	MP2-FMT-4K and MP2-25GE
	3840x2160	4:4:4 RGB	12b	23.98/24/25/29.97/30p	MP2-FMT-4K and MP2-PROD
	4096x2160	4:2:2 YCbCr	10b	23.98/24/25/29.97/30/50p	MP2-FMT-4K
	4096x2160	4:2:2 YCbCr	10b	59.94/60p	MP2-FMT-4K and MP2-25GE
	4096x2160	4:4:4 RGB	12b	23.98/24/25/29.97/30p	MP2-FMT-4K, MP2-25GE, and MP2-PROD

ST 2110-30 and -31 streams

Conformance level	Description
-------------------	-------------

ST 2110-30 and -31 streams

Conformance level A	Reception of 48-kHz streams with 1 to 8 channels at packet times of 1 ms
Conformance level B	Reception of 48-kHz streams with 1 to 8 channels at packet times of 1 ms or 1 to 8 channels at packet times of 125 μ s
Conformance level C	Reception of 48-kHz streams with 1 to 16 channels at packet times of 125 μ s

Note: PRISM instruments with 25GE module have up to four ST 2110-30 streams of reception with up to 16 audio channels, total.

Software Licenses

- MP2-25GE adds a node-locked license for 25GE support.
- MP2-IP-MEAS adds a node-locked license for IP Measurement feature sets, this includes IP/PTP Graph, IP/PTP Session, PIT Histogram, Timing, Stream Timing, and Stream capture applications.
- MP2-FMT-4K adds a node-locked license for 4K formats and enables 6G/12G-SDI.
- MP2-FMT-8K adds a node-locked license for 8K formats and enables 12G-SDI; 25GE upgrade kit is required for MPI2-10 and MPX2-10; MP2-FMT-4K is also required for 4K format support.
- MP2-AUD adds a node-locked license for enhanced audio feature sets, this includes Phase, Session, Correlation, Loudness, and Dolby E status display.
- MP2-DLBY adds a node-locked license for Dolby E, D, and D+ decoding. Also provides ED2 metadata in the Dolby Status application.
- MP2-ENG adds a node-locked license for baseband engineering feature sets, this includes Datalist, CC decode, and ANC Session.
- MP2-QC adds a node-locked license for quality control feature sets, this includes Datalist, CC decode, and ANC Session.
- MP2-PROD adds a node-locked license for production feature sets, this includes Stop, False Color, Light meter, HDR/WCG Conversion, CIE, and HDR Measurements. It also adds support for deep color formats for both receiver and generator if the Option MP2-GEN is purchased.
- MP2-GEN adds a node-locked license for SDI/IP signal generator, this includes IP/SDI Generator application.
- MP2-EXTNDSP adds a node-locked license for enabling extended desktop.
- MP2-SRND adds a node-locked license for surround sound display.
- MP2-MULTI adds a node-locked license for multi-channel input.

Rack Mounting

There are several options to mount the PRISM models in racks.

MPI2-25 Monitor

There are two optional dual rack cabinets (19-inch, 3RU) available for the PRISM monitor. Each of the cabinet kits include the *PRISM MPI Dual Rack Cabinet and Extender Installation Instructions* document (part number 071-3725-xx).

MPI-RACK-MM

Allows you to install one MPI unit or two MPI units side-by-side. Each side of the cabinet front panel has two USB ports and a headphone port for each MPI unit.

MPI-RACK-MW

Allows you to install one MPI unit or one MPI unit in a side-by-side installation with a WFM52x0, WFM7200, WFM8x00 waveform monitor. The left side of the cabinet front panel has two USB ports and a headphone port for one MPI unit.

Dual Rack Cabinet Versions

There are two versions of the instructions for the MPI-RACK-MM and MPI-RACK-MW dual rack cabinets:

PRISM dual rack cabinet documentation

Document	Part Number	Description
PRISM MPI Dual Rack Cabinet Version 1 Installation Instructions	071-3501-xx (English)	In version 1 of the instructions, the MPI-RACK-MM and the MPI-RACK-MW cabinets are the same size.
PRISM MPI Dual Rack Cabinet Version 2 Installation Instructions	071-3725-00x (English)	In the second version of the instructions, the MPI-RACK-MW cabinet comes with a removable extender installed that makes it longer than the MPI-RACK-MM cabinet.

MPX2-25 Monitor

For the PRISM MPX2-25 monitor, there is an optional 1RU full-rack kit that can be used for either portable or rackmount applications.

MPX2-25 RACK

Allows you to install one PRISM 1RU full width MPX2-25 RACK. The MPX2-25 RACK rack mounting kit includes the *Rack Mounting Slides and Rails Kit Installation Instructions* document (part number 071-3706-xx).

Dual Display Monitors

Rack mounted dual display monitors are available for MPI2 and MPX2 to extend the PRISM display to a second HD monitor.

MPI2-RACK-MD

Allows you to install one PRISM MPI2 monitor (not included) next to an external HD display in a 3RU full width rack. A software license is required to enable the extended display feature. For information on how to install and use this extended display, see the *PRISM MPI2-RACK-MD Installation and Safety Instructions*.

MPX2-DUALDSP

Allows you to connect an MPX2 to a 3RU full rack width dual display assembly to serve as a compact primary and extended desktop display system for the MPX2. A software license is required to enable the extended display feature. For information on how to install and use this extended display, see the *PRISM MPX2-DUALDSP Installation and Safety Instructions*.

MPI2-25 Power-on and Power-off Procedures

This section describes how to apply power to the MPI2-25 monitor and how to power-on and power-off the instrument.

International power cords

The instrument was shipped with one of these power cord options. Power cords for use in North America are UL listed and CSA certified. Cords for use outside North America are approved by at least one authority acceptable in the country to which the product is shipped.

PWR-CORD-NA-S15 – North America Power Cord

PWR-CORD-EURO – Universal EUR power cord

PWR-CORD-CHN – China power cord

PWR-CORD-IN – India power cord

PWR-CORD-UK – United Kingdom power cord

PWR-CORD-BRZ – Brazil power cord

PWR-CORD-AUS – Australia power cord

PWR-CORD-CHE – Switzerland power cord

PWR-CORD-JPN – Japan power cord

PWR-CORD-NONE – No power cord or AC Adapter



CAUTION: To reduce risk of fire and shock, use the certified power cord provided with the product.

MPI2-25 Power Cord Installation

This instrument is powered by an AC power source. Connect the power cord to the power connector on the rear panel of the instrument.

The power connector is keyed to be directional, with the flat portion of the power cord housing facing the left of the instrument (as viewed from the rear). When fully inserted, the power cord housing latches onto the instrument power connector.



CAUTION: To minimize the risk of damage to the instrument, we strongly recommend the power cord be connected to the instrument before the power cord is connected to the AC power source.

MPI2-25 Power Cord Removal

The power cord housing latches on the instrument power connector when fully inserted. To remove the power cord, grasp the connector housing, as shown, and firmly pull the cord away from the instrument.

 **CAUTION: To prevent damage to the power cord or to the instrument power connector, do not attempt to disconnect the power cord by pulling on the cable. You must pull on the connector housing to disengage the locking mechanism.**

 **CAUTION: To minimize the risk of damage to the instrument, we strongly recommend the power cord be disconnected from the AC power source before the power cord is disconnected from the instrument.**

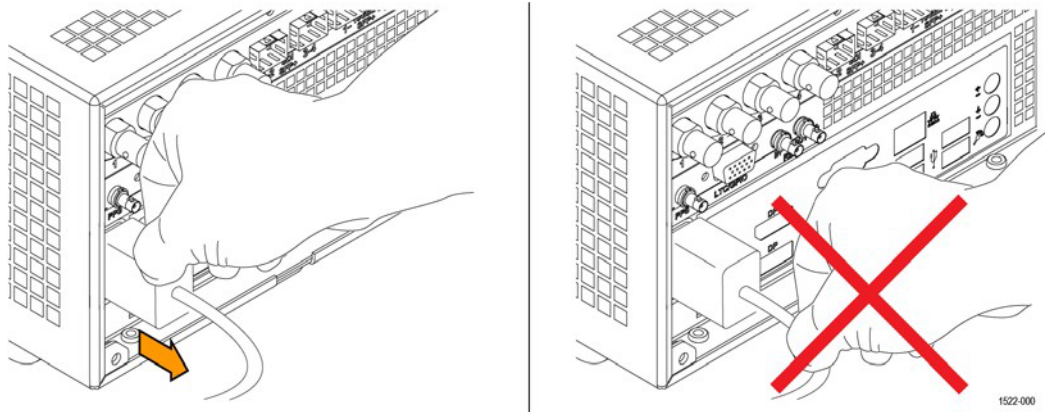

MPI2-25 Power-on Procedure

1. Connect power to the instrument. (See [MPI2-25 Power Cord Installation](#).)

Note: If the PRISM monitor was previously powered off by a power interruption or by disconnecting the power cord from the rear of the instrument, the instrument powers on when power is reconnected.

2. Press the power button on the instrument front panel to turn the instrument on.

Note: The MPI2-25 power button turns red during the power-on sequence, then turns white, and then turns off in normal operation.



MPI2-25 Power-off Procedure

1. Press the power button on the instrument front panel to turn the instrument off.
Or in the instrument:
 - A. Select **Settings**.
 - B. Select **Utilities**.
 - C. Select **Power**.
 - D. Select **Power Down Now**.

CAUTION: To prevent data loss, we strongly recommend you first shut down the instrument before disconnecting the power cord. Press the power button or select Settings, Utilities, Power, and then Power Down Now.

2. To completely remove power from the instrument, disconnect the power cord from the AC power source and then disconnect the power cord from the instrument.
(See [MPI2-25 Power Cord Removal](#).)

MPX2-25 Power-on and Power-off Procedures

This section describes how to apply power to the MPX2-25 monitor and how to power-on and power-off the instrument.

International power cords

Your instrument was shipped with one of these power cord options. Power cords for use in North America are UL listed and CSA certified. Cords for use outside North America are approved by at least one authority acceptable in the country to which the product is shipped.

PWR-CORD-NA-S15 – North America Power Cord

PWR-CORD-EURO – Universal EUR power cord

PWR-CORD-CHN – China power cord

PWR-CORD-IN – India power cord

PWR-CORD-UK – United Kingdom power cord

PWR-CORD-BRZ – Brazil power cord

PWR-CORD-AUS – Australia power cord

PWR-CORD-CHE – Switzerland power cord

PWR-CORD-JPN – Japan power cord

PWR-CORD-NONE – No power cord or AC Adapter



CAUTION: To reduce risk of fire and shock, use the certified power cord provided with the product.

MPX2-25 Power Cord Installation

This instrument is powered by an AC power source. Connect the power cord to the power connector on the rear panel of the instrument.

The power connector is keyed to be directional, with the flat portion of the power cord housing facing the left of the instrument (as viewed from the rear). When fully inserted, the power cord housing latches onto the instrument power connector.



CAUTION: To minimize the risk of damage to the instrument, we strongly recommend the power cord be connected to the instrument before the power cord is connected to the AC power source.

MPX2-25 Power-on Procedure

1. Apply power to the instrument. (See [MPX2-25 Power Cord Installation](#).)

Note: If the PRISM monitor was previously powered off by a power interruption or by removing the power cord from the rear of the instrument, the instrument powers on when power is reapplied.

2. Press the power button on the instrument front panel to turn the instrument on.

Note: The MPX power button turns red during the power-on sequence and turns green and remains green in normal operation.



MPX2-25 Power-off Procedure

1. Press the power button on the instrument front panel to turn the instrument off.
Or in the instrument:
 - A. Select **Settings**.
 - B. Select **Utilities**.
 - C. Select **Power**.
 - D. Select **Power Down Now**.



CAUTION: To prevent data loss, we strongly recommend you first shut down the instrument before disconnecting the power cord. Press the power button or select Settings, Utilities, Power, and then Power Down Now.

2. To completely remove power from the instrument, disconnect the power cord from the AC power source and then disconnect the power cord from the instrument.

SFP Module Installation

There are several types of optional SFP modules available:

- MP-SFP 10GESR is a 10G Ethernet short-range SFP+ transceiver (850 nm).
- MP-SFP 10GELR is a 10G Ethernet long-range SFP+ transceiver (1310 nm).
- MP-SFP 25GESR is a 25G Ethernet short-range SFP28 transceiver (850 nm).
- MP-SFP 25GELR is a 25G Ethernet long-range SFP28 transceiver (1310 nm).

Note: ST 2022-7 requires two 10GE (or 25GE) SFP modules to be installed. The modules must be installed in SFP ports 1 and 2.

Install SFP Module

To install an SFP module, insert the SFP module into the SFP connector. The module latches into place when fully inserted.

Note: There are different types of SFP modules for 10GE and 25GE signals. If the SFP module does not match the unit signal setting (for example, a 25GE SFP module is installed and the unit is set for a 10GE signal), the Link Status (in Network, under Settings) returns "SFP Error."

To remove the SFP module, pull down on the latch and then pull the module out of the SFP connector.

Note: To ensure you are using the correct SFP connectors, the 10GE, 25GE, and SDI SFP connectors are marked on the back of the MPI2-25 (see [MPI2-25 Rear Connectors](#)) and MPX2-25 (see [MPX2-25 Rear Panel Connectors](#)). Different types of SFP modules may have different latching mechanisms.

SFP Module Transportation

 **CAUTION:** To prevent static damage to the SFP module, if you remove the SFP module from the instrument, always store and transport the SFP module in an anti-static bag or container.

 **CAUTION:** To prevent possible damage to the PRISM monitor and SFP modules, remove the SFP modules before transporting the PRISM monitor.

Note: QSFP modules are not supported.

Network Installation

See the installation and safety instructions manual that shipped with the instrument for basic installation instructions.

After the instrument is physically installed, you might want to connect it directly to a PC or to a network. This section explains how.

Connect Directly to a PC

1. Connect the instrument directly to a PC with an Ethernet cable. You can also use an Ethernet Switch.
2. Set up the instrument as shown.

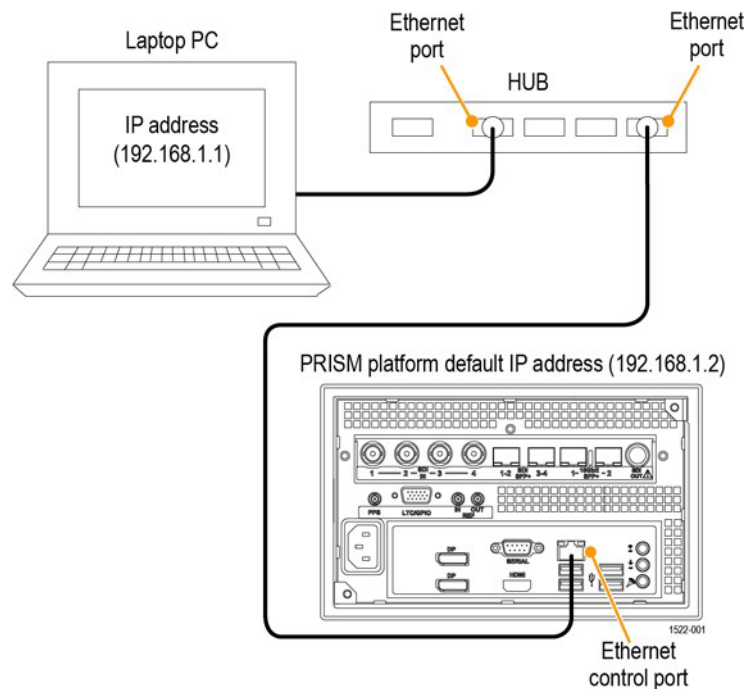

3. Choose Manual IP mode to set the IP address manually. Be sure to set an address that is compatible with the setting of your PC.

Note: The default IP address of the PRISM monitor is 192.168.1.2.

Connect to a Network

To allow network access to the instrument, you must set the IP address. Network addresses can be assigned either automatically (DHCP) or manually. If your network does not use DHCP, you must manually enter the address for the instrument. To get a fixed address, talk to your LAN administrator. The default IP address of the PRISM monitor is 192.168.1.2.

 **CAUTION: Remote connectivity can be lost when the control port and either video port are on the same subnet. It is possible to lose remote connectivity while working locally and not know the connectivity was lost. For details on this problem and how to avoid it, see [Connect with VNC Client](#).**

To connect the instrument to a network and access it with a remote PC:

1. On the PRISM monitor, select the **Settings** icon () to display the Settings menu.
2. Select **Network** to open the Network submenu.
3. Select **CONTROL IP PORT** to open the Control IP Port submenu.
4. Depending on your local network requirements, select DHCP or Manual to select the method for selecting an IP address.

 **CAUTION: If you select Manual, remote access can be lost if the addresses are not known and correct. Local access is required to select DHCP to reconnect remote access.**

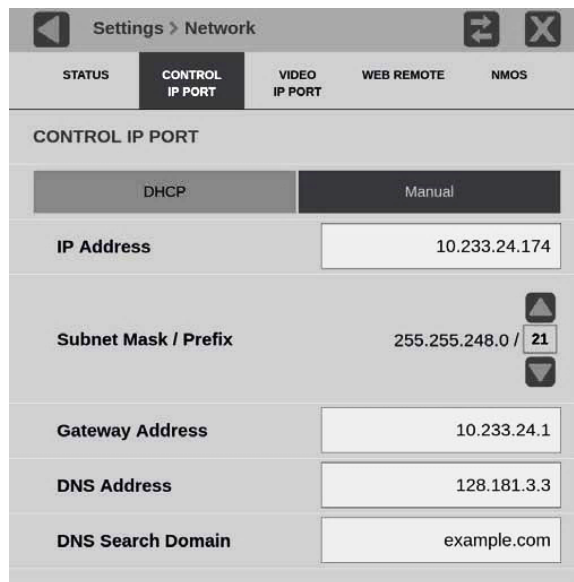

5. If you cannot use DHCP and you selected Manual, use the Manual submenu to set the IP address, subnet mask, gateway address, DNS address, and DNS Search Domain parameters you obtained from your LAN administrator. (Be sure to use compatible addresses between the PC and the instrument.)
6. Select an address box to open the address editing tool. Use the editing box as described for editing an IP input address.

 **CAUTION: IGMP communications can fail when the Video IP Ports are configured for the same IP Address.**

7. Select the **Settings** icon () or select the Close icon ()

MPI2-25 Rear Connectors

The illustration shows the external connections on the rear panel of the MPI2-25 instrument. A description of each connector is provided.

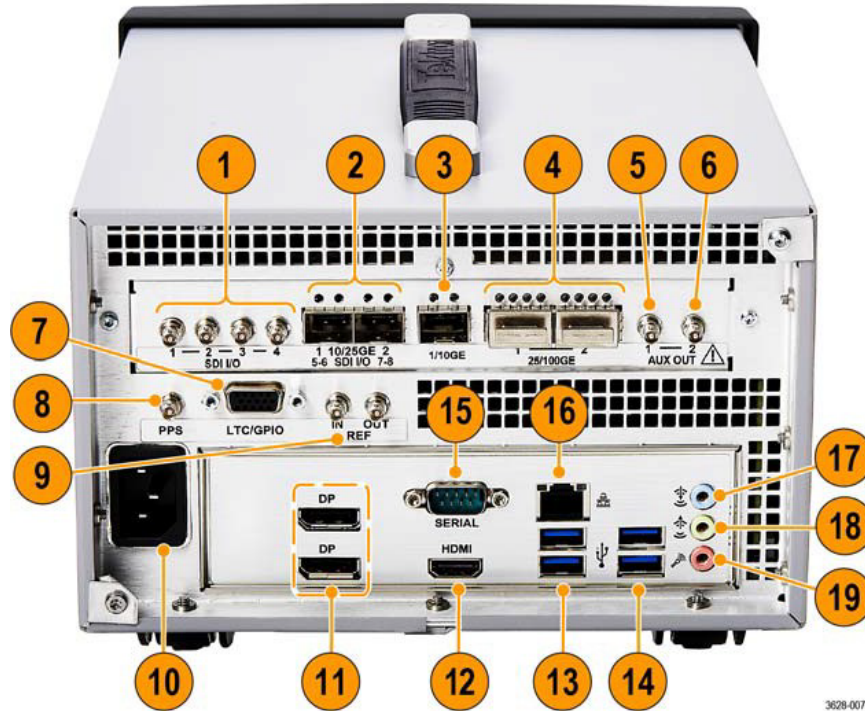

Table 1. Descriptions of numbered PRISM MPI2-25 rear-panel connectors

Item number	Connector label, symbol, or end	Description
1	SDI I/O	<p>Four HD-BNC inputs can operate in 4 modes:</p> <ul style="list-style-type: none"> • SDI inputs 1-4 support SD/HD/3G/6G/12G signals. • Single SDI link (Option MP2-FMT-4K is required for 6G/12G support), when used as a single link, only one of the SDI 1-4 inputs is active at a time. • Quad 4K links, when used in conjunction with the SDI 1-4 inputs (Option MP2-FMT-4K only). When used as Quad 4K links, all four SDI inputs are active. • Eye diagram is up to 12G on SDI input 1 only for physical layer measurements, including automated measurement of 12G-SDI eye pattern parameters (requires Options MP2-FMT-4K and PHY).

Table 1. Descriptions of numbered PRISM MPI2-25 rear-panel connectors







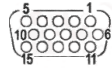

Item number	Connector label, symbol, or end	Description
2	10/25GE SDI I/O	Two SFP module slots can be configured for SDI or IP applications. <ul style="list-style-type: none"> 10/25GE: Two optional SFP+ ports are for 10/25GE Ethernet applications. See MP-SFP products for available modules. SDI I/O: Two optional SFP+ ports for future functionality.
3	1/10GE	SFP IP port is for future functionality.
4	25/100GE	Two QSFP28 ports are for future functionality.
5	AUX OUT 1	AUX OUT is for SDI output of the selected SDI, ST 2022, or 2110 input; or it is an SDI generator output (GEN license is required): <ul style="list-style-type: none"> For quad link inputs (4K or 8K) the AUX OUT 1 is link 1. ST 2110-20/30/31 inputs are supported.
6	AUX OUT 2	AUX OUT is for SDI output of the selected SDI, ST 2022, or 2110 input; or it is an SDI generator output (GEN license is required): <ul style="list-style-type: none"> For quad link inputs (4K or 8K) the AUX OUT 2 is link 1. ST 2110-20/30/31 inputs are supported.
7	LTC/GPIO 	LTC/GPIO is a 15-pin, micro D-sub connector, see LTC/GPIO remote connector pin assignments and preset functions.
8	PPS	PPS connector outputs a 1 PPS (pulse per second) signal when the instrument is locked to a PTP reference. 3.3v drive. TTL compatible.
9	REF IN – OUT	REF IN is used for analog reference signals black burst and tri-level sync for locking. REF OUT is a pass through of the REF IN.
10	AC In	Connector for an AC power source.
11	DP	Two DisplayPort outputs are for external monitors. The output video format is 1920×1080. ¹ <p>Note: An MPI2-25 can use a maximum of 1 external display, DP or HDMI.</p>
12	HDMI	HDMI port output is for an external monitor. The output video format is 1920×1080. ¹ <p>Note: An MPI2-25 can use a maximum of 1 external display, DP or HDMI.</p>

Table 1. Descriptions of numbered PRISM MPI2-25 rear-panel connectors

Item number	Connector label, symbol, or end	Description
13		Two USB 3.0 ports are for connecting a mouse and keyboard, importing or exporting instrument presets, upgrading the instrument firmware, or saving screen and stream captures.
14		Two USB 3.0 ports are for connecting a mouse and keyboard, importing or exporting instrument presets, upgrading the instrument firmware, or saving screen and stream captures.
15	SERIAL 	Serial interface, 9-pin connector, is not used.
16		Ethernet port is a standard RJ-45 connector for 10/100/1000Base-T Ethernet cable.
17		Audio input port is for future use.
18		Audio output (1/8-inch—3.5mm—line out) port is for headphones to listen to the selected audio channel pair. ²
19		Microphone input port is for future use.

- 1 When connecting to an external monitor, a monitor with a 1920×1080 capable display works best with the instrument.
- 2 Audio output is an 1/8-inch (3.5mm) diameter port for a headset. It has connections for L and R audio channels. Headset plugs that are an 1/8-inch and have an additional contact for a microphone may not work because the headphone ports are not set for the spacing requirements of a third connection on the plug.

Table 2. LTC/GPIO remote connector pin assignments and preset functions

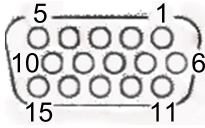
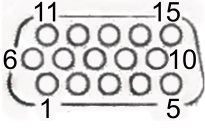
Characteristic	Pin Function
MPI2-25 Connector Pin Assignments 	1 GND
	2 Do not connect
	3 Do not connect
	4 Do not connect
	5 Do not connect
	6 GND
MPX2-25 Connector Pin Assignments 	7 Do not connect
	8 Do not connect
	9 Do not connect
	10 Preset A1 recall ¹
	11 Preset A2 recall ¹
	12 Preset A3 recall ¹
	13 Preset A4 recall ¹
	14 Preset A5 recall ¹
	15 Preset A6 recall ¹

1. Active low inputs, internally pulled up to 5 V. A 5 V tolerant open drain or open collector driver is recommended.

Note: The MPX2-25 GPIO is inverted compared to standard use. The pin functions are the same but the numbering begins in the lower left.

Recall Preset through GPIO

Ground and release the pin related to the preset (for example, pin 10 for preset A1) to a ground (pin 1 or 6). The GPIO must be turned on:

1. Select the **Settings** icon (), select **Utilities**, and then select **GPIO**.
2. Set Preset Recall to **On**.

Or through API:

At the API command line, to turn the GPIO recall on, send:

`GPIO_PRESET_RECALL_ENABLE_ON`

To turn the GPIO recall off, send:



`GPIO_PRESET_RECALL_ENABLE_OFF`

MPX2-25 Rear Panel Connectors

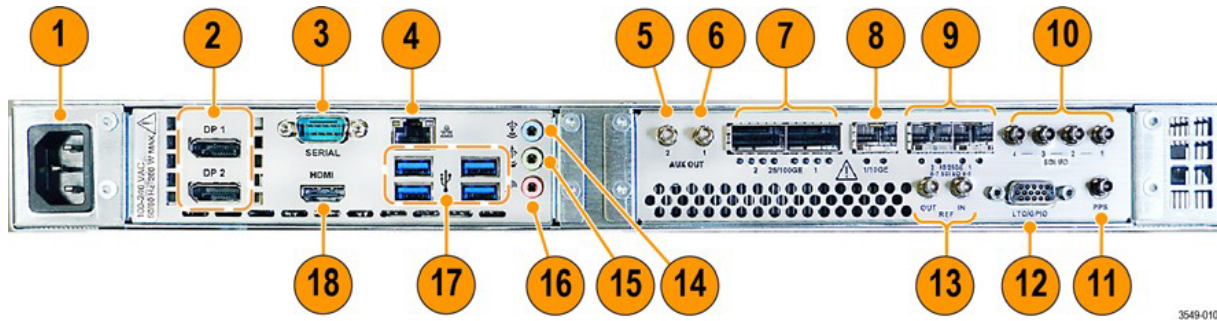

The next illustration shows the external connections on the rear panel of the MPX2-25 instrument. A description of each connector is provided. See [MPX2-25 Front-panel Controls](#) for information about the front panel connectors.



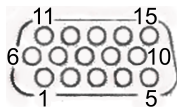

Descriptions of numbered PRISM MPX2-25 rear-panel connectors

Item number	Connector label, symbol, or end	Description
1	AC In	Connector is for an AC power source.
2	DP	Two DisplayPort outputs are for external monitors. The output video format is 1920x1080. ¹
<p>Note: An MPX2-25 can use a maximum of 2 external displays, DP or HDMI. For details on using 2 displays in extended mode, see Extended Display Mode.</p>		
3	SERIAL	Serial interface, 9-pin connector, is not used.
		
4		Ethernet port is a standard RJ-45 connector for 10/100/1000Base-T Ethernet cable.
5	AUX OUT 2	SDI output of the selected SDI, ST 2022, or 2110 input: <ul style="list-style-type: none"> • Quad link inputs (4k/8k) the Aux out is link 1 • ST 2110-20/30 inputs are supported.
6	AUX OUT 1	SDI output of the selected SDI, ST 2022, or 2110 input: <ul style="list-style-type: none"> • Quad link inputs (4k/8k) the Aux out is link 1 • ST 2110-20/30 inputs are supported.
7	25/100GE	Two QSFP28 ports are for future functionality.
8	1/10GE	SFP+ IP port is for future functionality.

Descriptions of numbered PRISM MPX2-25 rear-panel connectors

Item number	Connector label, symbol, or end	Description
9	10/25GE SDI I/O	Two SFP+ module slots can be configured for SDI or IP applications. <ul style="list-style-type: none"> • 10/25GE: Two optional SFP+ ports are for 10/25GE Ethernet applications. See MP-SFP products for available modules. • SDI I/O: Two optional SFP+ ports for future functionality.
10	SDI I/O	Four HD-BNC inputs can operate in 4 modes: <ul style="list-style-type: none"> • SDI inputs 1-4 support SD/HD/3G/6G/12G signals. • Single SDI link (Option MP2-FMT-4K is required for 6G/12G support), when used as a single link, only one of the SDI 1-4 inputs is active at a time. • Quad 4K links, when used in conjunction with the SDI 1-4 inputs (Option MP2-FMT-4K only). When used as Quad 4K links, all four SDI inputs are active. • Quad 8K links, when used in conjunction with the SDI 1-4 inputs (Option MP2-FMT-8K only). When used as Quad 8K links, all four SDI inputs are active. • Eye diagram is up to 12G on SDI input 1 only for physical layer measurements, including automated measurement of 12G-SDI eye pattern parameters (requires Options MP2-FMT-4K and PHY).
11	PPS	PPS connector outputs a 1 PPS (pulse per second) signal when the instrument is locked to a PTP reference. 3.3v drive. TTL compatible.
12	LTC/GPIO 	LTC/GPIO is a 15-pin, micro D-sub connector, see LTC/GPIO remote connector pin assignments and preset functions. <p>Note: The GPIO in the MPX2-25 is inverted compared to standard use. The pin functions are the same but the numbering begins in the lower left.</p>
13	REF IN – OUT	REF IN is used for analog reference signals black burst and tri-level sync for locking. REF OUT is a pass through of the REF IN.
14		Audio input port is for future use.
15		Audio output (1/8-inch—3.5mm—line out) port is for headphones to listen to the selected audio channel pair. ²

Descriptions of numbered PRISM MPX2-25 rear-panel connectors

Item number	Connector label, symbol, or end	Description
16		Microphone input port is for future use.
17		Four USB 3.0 ports are for connecting a mouse and keyboard, importing or exporting instrument presets, upgrading the instrument firmware, or saving screen and stream captures.
18	HDMI	HDMI port output is for an external monitor. The output video format is 1920×1080. ¹

Note: An MPX2-25 can use a maximum of 2 external displays, DP or HDMI. For details on using 2 displays in extended mode, see [Extended Display Mode](#).

- 1 When connecting to an external monitor, a monitor with a 1920×1080 capable display works best with the instrument.
- 2 Audio output is an 1/8-inch (3.5mm) diameter port for a headset. It has connections for L and R audio channels. Headset plugs that are an 1/8-inch and have an additional contact for a microphone may not work because the headphone ports are not set for the spacing requirements of a third connection on the plug.

Display Elements



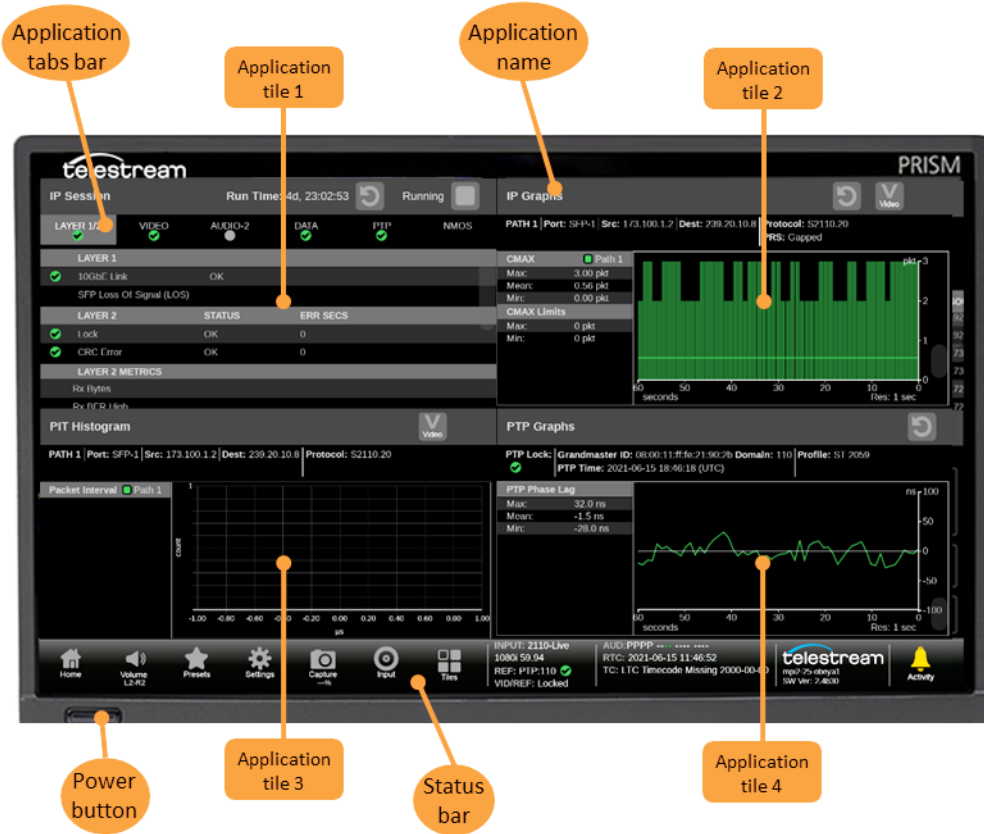





The illustration shows the key elements of the MPI2-25 internal monitor. Descriptions of the elements are provided in the Descriptions of PRISM Display Elements table.



Descriptions of numbered PRISM MPI2-25 Display Elements

Item number	Description
Applications tabs bar	Some applications have selectable tabs (highlighted readouts) you can use to display additional information.
Application tiles 1-4	Location of the application tile ¹
Application name	Lists the name of the displayed application.

Descriptions of numbered PRISM MPI2-25 Display Elements

Item number	Description
Power button	Press the button to turn the instrument on or off. To completely remove power from the instrument, remove the power cord.
	CAUTION: To prevent data loss, we strongly recommend you first shut down the instrument before disconnecting the power cord. Press the power button or select Settings, Utilities, Power, and then Power Down Now.
Status bar	<p>Status bar: The left side of the Status bar has icons with links to various instrument settings including Volume ()¹, Presets ()¹, Settings ()¹, Input type ()¹, and the Tile application menu ()¹. Select the Home icon () to exit any displayed menus.</p> <p>The right side of the Status bar lists instrument status such as the selected input, type of input signal, selected signal reference, video/reference signal status, audio channel status, the real-time clock or PTP clock (to switch between the clocks, see Set Time and Date), and a link to the Activity menu ()¹.</p> <p>Note: When an instrument setting is selected, the associated menu replaces the Status bar.</p>

¹ The applications tiles can be in quarter-screen display, half-screen display, or one application in full-screen display.

Activity Center

The Activity center tracks messages and devices in the PRISM. For example, you can view messages that allow you to eject devices mounted to the instrument. These steps explain how to eject a USB drive from the instrument using the Activity center.



A number above the Activity icon indicates the number of messages waiting in and devices connected to the instrument. The instrument can use USBs formatted to FAT32.



1. Select the Activity icon to view the DASHBOARD messages, which includes devices connected to the instrument.

Note: After inserting a USB drive, it must be unmounted through the Activity icon before removing it from the instrument.

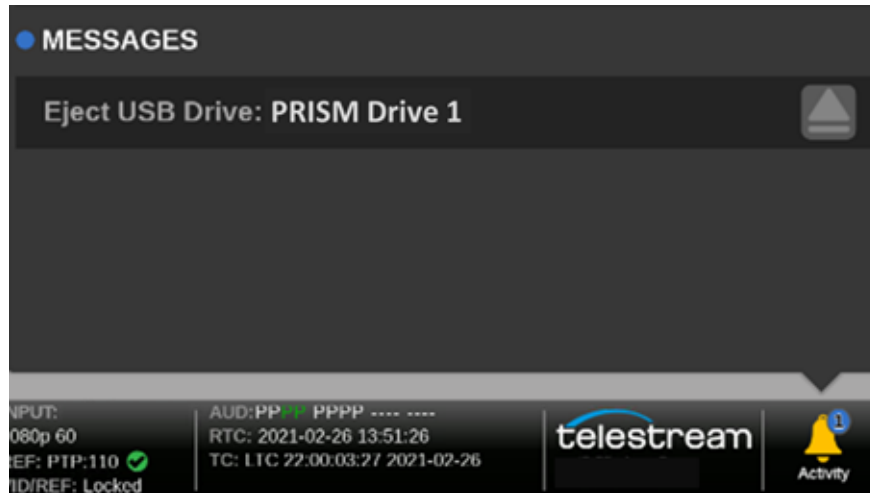

2. Select the Eject icon (🗑️) to unmount the USB drive from the instrument.

Note: If there is no USB drive in the instrument, the Eject USB Drive text and eject icon do not appear.

3. Select the Activity icon (🔔) again to close the window.

Monitor Alarms

The Activity DASHBOARD, in the status bar, provides a user-configurable alarm notification system. This allows the user to be only notified of the alarms of interest.

To configure which alarms you receive notifications for, select **Settings** menu, and then **Alarm**.

The Activity icon is color coded:

- A gray icon means no alarms have been activated.



- A yellow icon means at least one alarm was activated, but it has cleared.



- A red icon means at least one alarm is currently activated.

Note: Active alarms take precedence over cleared alarms. If there are cleared alarms and active alarms, the icon is red.



Use Activity DASHBOARD

To *open* the closed Activity DASHBOARD, select the **Activity** icon (🔔).

To *close* the open Activity DASHBOARD, select the **Activity** icon (🔔).

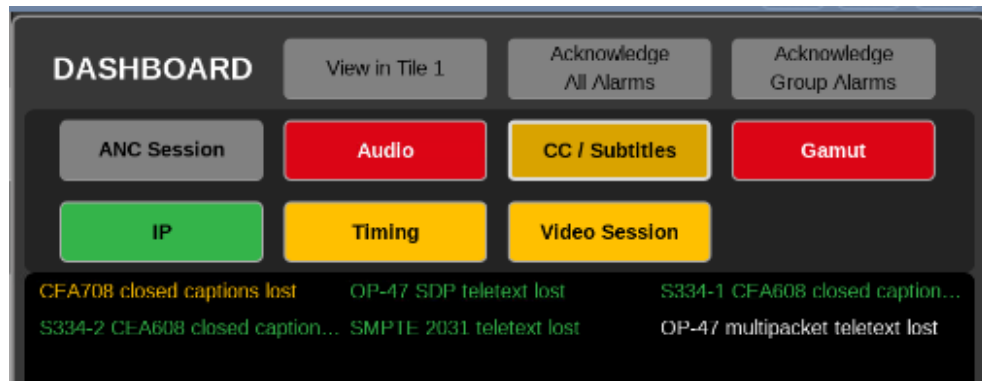

The alarm group buttons and the alarm titles are color-coded.

- The Group buttons (ANC Session, Audio, etc.) color coding:
 - A gray button means no alarms in the group are turned on in the DASHBOARD.
 - A green button means at least one alarm in the group is turned on but no alarms are active.
 - A yellow button means at least one alarm in the group has been activated but it has cleared.
 - A red button means at least one alarm in the group has been activated and it is still active.

Note: A red (still active) alarm takes precedence over yellow. If there are both active and cleared alarms in the group, the button is red.

- The alarm titles (under the group buttons) color coding:
 - A white title means the alarm is *not* turned on in the DASHBOARD.
 - A green title means the alarm is turned on in the DASHBOARD and the alarm is not active.
 - A yellow title means the alarm was activated but it has cleared.
 - A red title means the alarm was activated and it is still active.

Turn Alarms On or Off in DASHBOARD

Note: Turning alarms off means they are not tracked in the DASHBOARD or through the Activity icon. No color change or alarm occurs. The alarms are still logged in the Event Log application and sent to the Syslog server, if enabled.

1. In the status bar, select the **Settings** icon and then select **Alarms**.
2. Select the alarms to turn on in the DASHBOARD.
 - To turn on a group or groups of alarms in the DASHBOARD, select the checkbox of any alarm group.
 - To turn an alarm group off, clear the checkbox.

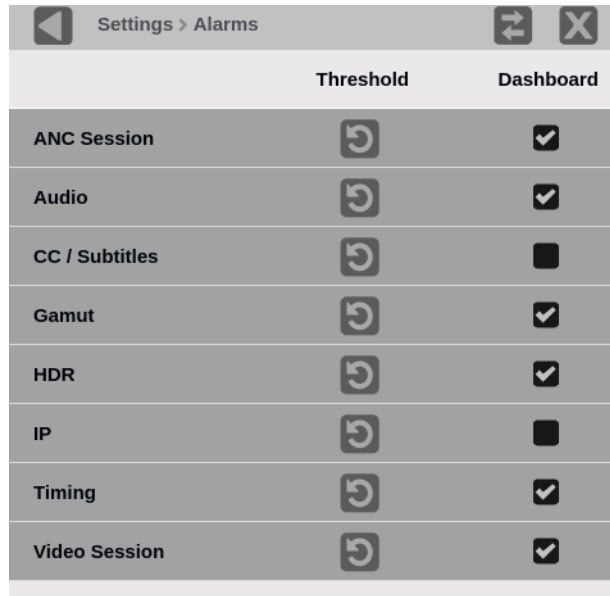

	Threshold	Dashboard
ANC Session		<input checked="" type="checkbox"/>
Audio		<input checked="" type="checkbox"/>
CC / Subtitles		<input type="checkbox"/>
Gamut		<input checked="" type="checkbox"/>
HDR		<input checked="" type="checkbox"/>
IP		<input type="checkbox"/>
Timing		<input checked="" type="checkbox"/>
Video Session		<input checked="" type="checkbox"/>

- To turn on any specific alarm or alarms, select the title of a group of alarms to see the individual alarms and select the checkbox of any specific alarm.
- To turn an alarm off, clear the checkbox.

Alarm	Threshold	Dashboard
Audio Signal Lost	N/A	<input checked="" type="checkbox"/>
Audio Over error	>-2 dB for >1 s	<input type="checkbox"/>
Audio Pair Out Of Phase	<-30% for >1 s	<input checked="" type="checkbox"/>

- To set the thresholds for alarms (an alarm with N/A under Threshold does not have thresholds to set), select anywhere in the alarm line and select the up or down arrows to change the threshold settings.

Alarm	Threshold	Dashboard
Audio Signal Lost	N/A	<input checked="" type="checkbox"/>
Audio Over error	>-2 dB for >1 s	<input type="checkbox"/>
Duration <input type="text" value="1"/> s Max <input type="text" value="-2"/> dB		
Audio Pair Out Of Phase	<-30% for >1 s	<input checked="" type="checkbox"/>

Acknowledge Alarm Notifications

The notification of alarms can be acknowledged (set the alarms to green) through two methods in the Activity DASHBOARD:

DASHBOARD View in Tile 1 Acknowledge All Alarms Acknowledge Group Alarms

ANC Session Audio CC / Subtitles Gamut

IP Timing Video Session

CFA708 closed captions lost OP-47 SDP teletext lost S334-1 CFA608 closed caption...

S334-2 CEA608 closed caption... SMPTE 2031 teletext lost OP-47 multipacket teletext lost

- To acknowledge all of the alarms in the DASHBOARD, at the top of the DASHBOARD, select **Acknowledge Alarms**.

All the alarms and all the group buttons are set to green, unless an alarm is still asserted, in that case the alarm, and the related group button, remains red.

- To acknowledge all of the alarms in the selected alarm group, at the top of the DASHBOARD, select **Acknowledge Group**.

All the alarms in the selected group and the group button are set to green, unless an alarm is still asserted, in that case the alarm, and the related group button, remains red.

Use Alarm Groups

Alarm groups allow sorting alarms for easier checking and clearing. They can also be sorted by group in Event Log.

Choose Alarm Group

Select the group button from the options below the DASHBOARD header (ANC Session, Audio, etc.). The alarm group is circled in white and the alarms in that group appear below the group buttons.

See Alarms in Event Log Application

Select **View in tile 1** at the top of the DASHBOARD.

- The Event Log application displays in tile 1.
- The errors are filtered by the group currently selected Dashboard Alarm Group.

Filter Event Log Alarms by Group

Select an alarm group and select **View in tile 1**.

Methods of Operation

This section describes the primary methods of operating the instrument:

- MPI2-25 front panel touchscreen
- MPX2-25 front panel controls
- Keyboard and mouse
- Remote control using VNC
- Remote control using API commands
- Remote control through NMOS

Touchscreen Operation

This section explains how to set up a second touchscreen display and how to use the touchscreens with the applications. The illustration shows the PRISM display in four-tile mode with the All Application menu open.

Note: Your available applications could vary from the example. Your available applications depend on the model of PRISM you have and the options installed.

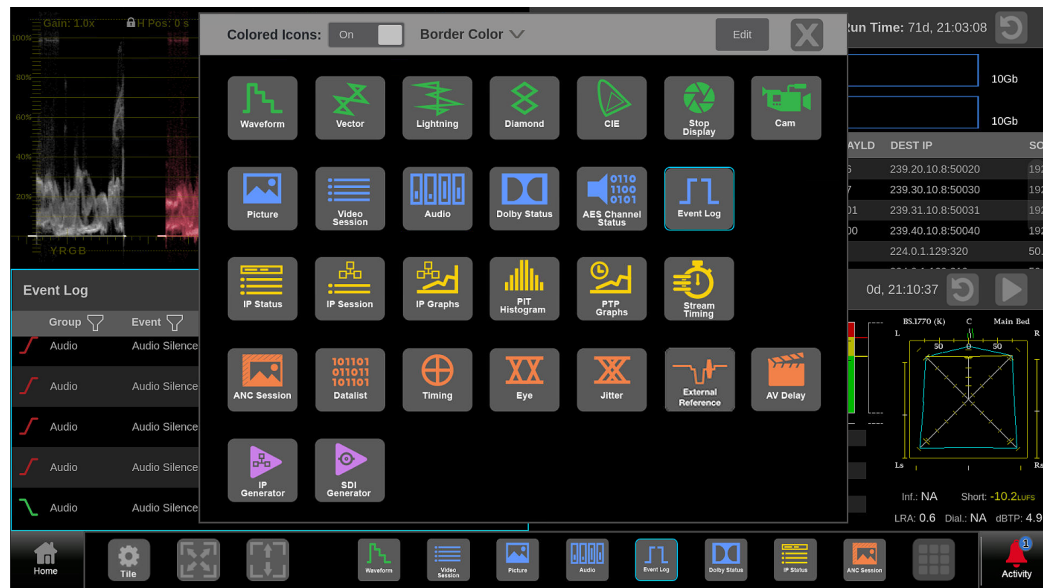

Supported Touchscreen Gestures

Use these touchscreen gestures to control the instrument:

- Touch or tap the screen to select display elements.
- Double tap an application to change the display between a quarter-screen and a full-screen display or between a half-screen tile and a full-screen display of the selected application. Double tap a full-screen display to return to the quarter- or half-screen tile.
- Swipe up or down, or left or right as necessary to move through menus and preset listings and to view additional application information.
- Some applications support pinch and zoom.

Note: The terms “tap”, “swipe”, and “pinch” apply to the touchscreen on the instrument. If you are using a mouse and keyboard you must “click”, “scroll” and use the scroll wheel on the mouse.

Touchscreen Feedback

To see where you have touched on a monitor (only in touchscreen enabled monitors), you can activate an on-screen marker.

To turn on the Touch Indicator:

1. Select the **Settings** icon () to open the Settings menu.
2. Select **Utilities** to open the Utilities submenu and select **Touch Settings**.
3. Select the touch indicator size from the options: Dot, Small, Med, or Large.

The Touch Indicator Example shows what the indicator will look like.

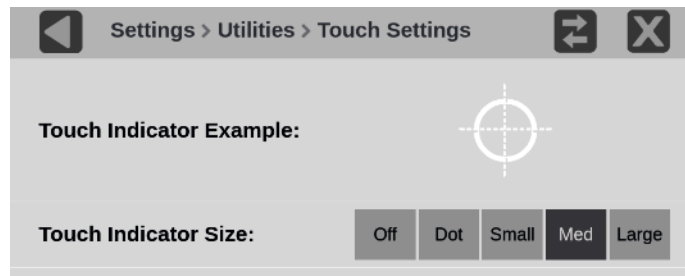

To turn off the Touch Indicator, in the Touch Settings menu, in the Touch Indicator Size options, select **Off**.

Select and Organize Applications

Open a different application in a tile:

1. In the Status bar, select the **Tiles** icon () to open the Application menu, shown.



Note: The applications visible in the Applications toolbar can be changed by the user to any number of applications, up to eight, in any order.

2. Select a tile to replace with a different application.
3. Select an application from the Application bar.
4. If an application is not on the Application bar, select the All Application menu icon () on the right of the Application bar.
5. Select the new application from the All Application menu.

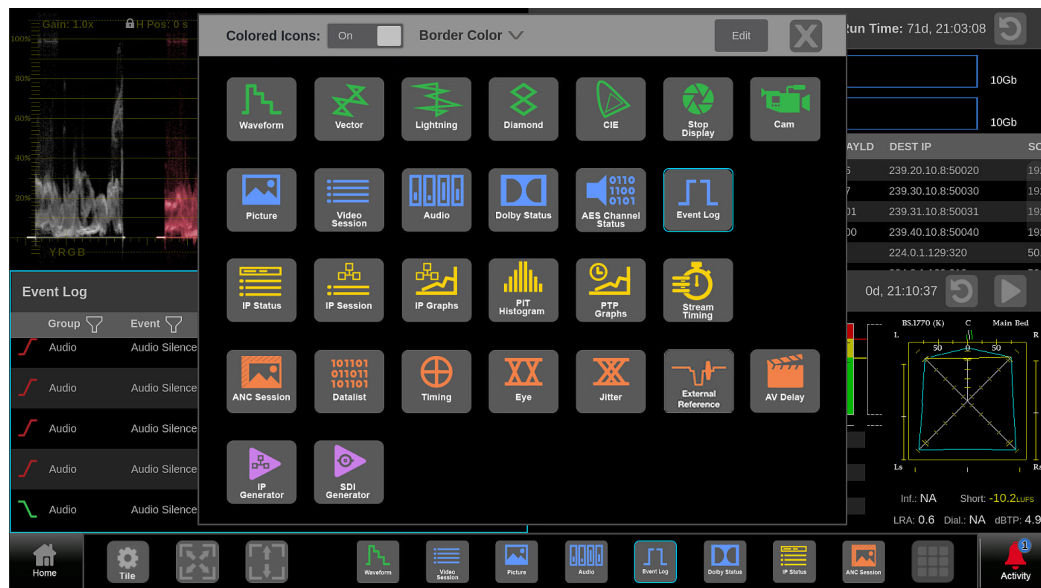

Note: The applications in the All Applications menu can vary depending on what options were purchased.

Change Applications in Application Menu

1. In the All Applications menu, select **Edit** from the menu header.
 - Select an application marked with a number to remove it from the Application bar.

Note: Removed applications leave that space open in the Application bar only while the menu is in edit mode. If there is a space in the application list when the changes are saved, the applications are consolidated on the left and any spaces are moved to the right.

- Select **Clear All** to remove all the applications from the Application bar.
 - Select an application that is not marked with a number to add it to an empty space in the Application bar.
-

Note: The applications are added to the Applications menu from the left. If the number 1 and 2 spaces are empty, the next selected application is added to the number 1 space.

2. Select **Save** in the All Applications menu.

If you do not save the changes (if you select the Close icon (✕) before saving) a warning appears asking if you want to save the changes. Select Ok to save the changes or Cancel to close the All Applications menu and return the Application bar to the layout before you selected Edit.

3. Select the Close icon (✕) to close the All Application menu.

Access Application Settings Menu

1. Select the tile with the application.
2. Select the **Tiles** icon (☐) on the left of the Application bar.
3. Select the **Tile** icon (⚙️).

The application Settings menu is displayed.

Change Design of Interface (Two Options)

Application icons in the Tiles menu and the All Applications menu can be seen in color or gray scale. And the highlight color for the selected application and the selected tile can be changed for easier visibility.

Turn Color of Application Icons On or Off

This applies to the applications in the All Applications menu and the Applications bar.

1. Select the **Tiles** icon (☐) and then select the All Application menu icon (☐).
2. In the All Applications menu header, select the Colored Icons button to change the icon colors on or off.

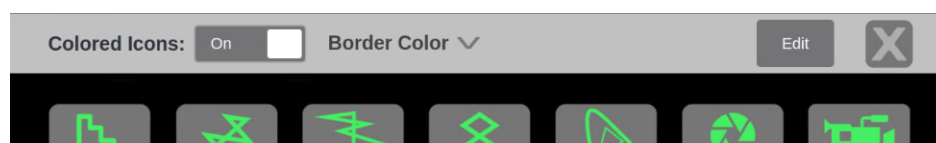

Change Selected Application Border Color

1. Select the **Tiles** icon (🗃️) and then select the All Application menu icon (📄).
2. In the All Applications menu header, select **Border Color** to open the color options menu.
3. Select Blue, White, or Yellow.

The border of any selected tile is highlighted in the chosen color.

Manage Tile Display

Each application can be independently changed to quarter, half, or full screen based on your requirements. The default for the PRISM instrument is to display four quarter screen tiles. These configurations show how to expand the applications to half or full screen tiles and reduce them back to a quarter of the screen.

Half-Screen Tiles



There are several half-screen configurations. Select the Tiles icon (🗃️) and then select the half-screen icon (📄) to enlarge the tile vertically and the reduce icon (📄) to return to quarter screen.





Quarter-screen Tiles

Sizing tiles to a quarter screen allows you the flexibility to view up to four tiles at the same time. There are two ways to change between quarter-screen mode and larger displays:

Expand Tile to Entire Monitor (Full-screen Mode)

- Double click or double tap an application to change between quarter-screen tile and full-screen mode.
- Select the **Tiles** icon () to open the Application bar and select the reduce icon () or the full-screen icon () to change between modes.

Extend Tile Vertically (Half-screen Mode)

- In the Application bar, select the half-screen icon () to expand the tile vertically.
- Select the reduce icon () to change the tile to a quarter-screen.



On-screen Tools

Some settings for the Waveform, Vector, Lightning, and Stop Display applications are available outside the settings menu through on-screen tools. Applications with on-screen tools enabled have buttons on the top and bottom of the display that allow you to adjust the application settings. When first selecting one of the displays, a highlighted ring appears around each available on-screen tool such as Gain, Format, Sweep, Cursors and Position. For instructions on how to use each on-screen tool, see these application sections:

- [Waveform Application On-screen Tools](#)
- [Vector Application On-screen Tools](#)
- [Stop Display Application On-screen Tools](#)
- [Lightning Application On-screen Tools](#)
- [CAM Application On-screen Tools](#)

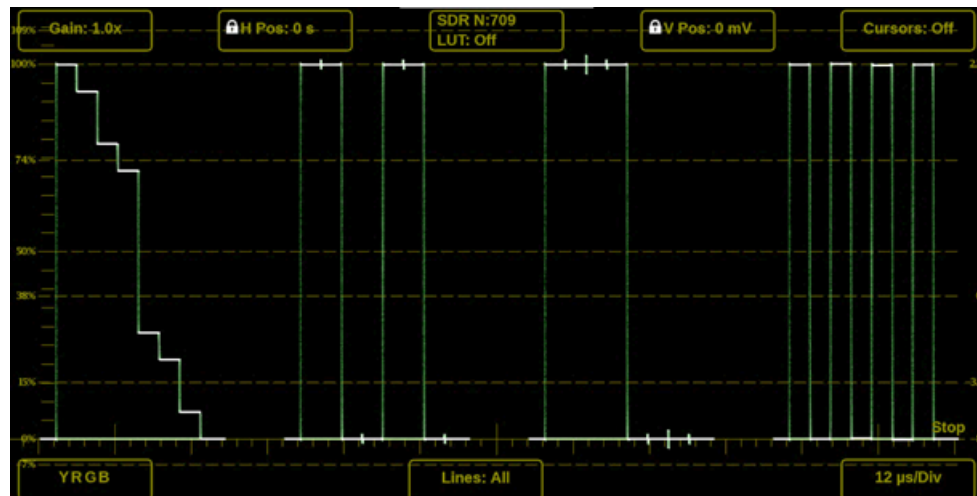

Keyboard and Mouse Operation

You can use a USB keyboard and mouse to operate the instrument. The mouse must have a scrolling wheel to access all of the menu selections. Click on applications to perform actions like you would on the touch panel.

Connect the keyboard and mouse:

- Use the USB ports on the rear panel of the instrument (MPI2-25) or front panel (MPX2-25).
- Use the USB port on the front of the optional dual rack cabinet (MPI-RACK-MM or MPI-RACK-MW).
- Connect the external monitor to any of the available display outputs, including Display Port or HDMI (MPX2-25).

Home Icon: The ESC key on the keyboard is mapped to function as the Home icon, which closes any displayed menus.

Volume Control: If your keyboard has volume control keys, you can use them to control the volume of the audio output on the instrument.

Input and Preset Selection: Keyboard controls for selecting SDI inputs and instrument presets lists the keyboard controls to quickly select between the SDI inputs and to select from instrument presets 1 through 6.

Keyboard controls for selecting SDI inputs and instrument presets

Action	Keyboard control	Result
Input	ALT+i	Prepares the instrument for an input selection.
Preset	ALT+p	Prepares the instrument for a preset selection from preset Group A. Repeat 2-5 times to select preset Group B-F.
Select 1	1	Selects Input 1 or selects Preset 1 from the selected preset group.
Select 2	2	Selects Input 2 or selects Preset 2 from the selected preset group.
Select 3	3	Selects Input 3 or selects Preset 3 from the selected preset group.
Select 4	4	Selects Input 4 or selects Preset 4 from the selected preset group.
Select 5	5	Selects Input 5 or selects Preset 5 from the selected preset group.
Select 6	6	Selects Input 6 or selects Preset 6 from the selected preset group.

To select an SDI input or instrument preset:

1. On the keyboard, use one of two options:
 - Press **ALT** and **i** at the same time to make an input selection change.
 - Press **ALT** and at the same time press **p** one time to recall a preset from Preset Group A. Press the letter *p* 2-5 times to select a preset from another Preset Group (B-F). For example, press ALT and at the same time and press p three times to make a selection from Preset Group C.
2. Press a number from 1 to 6 to select the input or to select a preset from the selected Preset Group (A-F).

MPX2-25 Front-panel Controls

The next illustration shows the key controls on the front panel of the MPX2-25. Descriptions of the elements are provided.



Descriptions of numbered PRISM MPX2-25 front-panel controls

Item number	Description
1	Power / Standby button: Press to turn the instrument on or off. To completely remove power from the instrument, remove the power cord.
	 CAUTION: To prevent data loss, we strongly recommend you first shut down the instrument before disconnecting the power cord. Press Power / Standby or select Settings, Utilities, Power, and then Power Down Now.
2	BALANCE control: Turn to adjust the balance on the front and rear panel headphone and optional speaker outputs. Push the BALANCE control to re-center the balance.
3	PRESET button: Press one time to prepare the instrument for a preset selection from preset Group A using the SELECTIONS buttons (1-6). Press the button repeatedly to select preset Group B-F.
4	SELECTIONS buttons (1-6): After pressing the PRESET or INPUT button, press one of the SELECTIONS buttons (1-6) to recall an instrument preset or to select an input to monitor.
5	VOLUME control: Turn to adjust the volume on the front and rear-panel headphone outputs. Push the VOLUME control to mute or unmute the audio.
6	Audio output: (1/4-inch—6.35mm—line out) port is for using headphones to listen to the selected audio channel pair.
7	USB ports: There are two USB 3.0 ports for connecting a mouse and keyboard, importing or exporting instrument presets, upgrading the instrument firmware, or saving screen and stream captures.

Descriptions of numbered PRISM MPX2-25 front-panel controls

Item number	Description
8	INPUT button: Press to prepare the instrument for an input selection using the SELECTIONS buttons (1-6).
9	Speakers: There are two integrated 2.1 speakers for listening to the selected audio channel pair. Requires Option SPKR.

MPX2-25 Front Panel Operation

Use the instrument front panel to perform these functions:

- Recall instrument presets
- Select an input to monitor
- Control or mute the volume on the headphone and optional speaker outputs
- Adjust the balance on the headphone and optional speaker outputs
- Connect a mouse and keyboard
- Connect a USB drive to upgrade the instrument or save screen and stream captures

Recall Instrument Presets

To recall instrument presets using the front panel:

1. Press the PRESET button one time to prepare the instrument for a preset selection from preset Group A using the SELECTIONS buttons (1-6).
2. Press the PRESET button repeatedly to select preset Group B-F. The selected preset group is displayed.
3. After you select the preset group, press the SELECTIONS numbered button corresponding to the preset in that group you want to recall (1-6).

Note: When you use the PRESET or INPUT buttons, the menus appear on the display. The menus close after a short delay. Similarly, when you use the VOLUME control, the volume and mute controls appear on the display and close after a short delay.

Select an Input to Monitor

To select an input to monitor using the front panel:

1. Press the INPUT button to prepare the instrument for an input selection.
2. Press the SELECTIONS numbered button corresponding to the input you want to monitor.

Display Operation

This section explains how to set up a second (extended) display for an MPI2. It also explains how to set up a single or dual display for an MPX2.

Configure MPI2 Extended Display

Extending the display requires two connections and software option MP2-EXTNDSP; without the option the extended display will mirror the MPI2 display.

- Connect the Display Port output from the MPI2 monitor to the input on the external device.
- Connect the output of the external device to one of the MPI2 monitor USB ports.

Note: A monitor with a 1920×1080 capable display works best with the instrument.

Note: Extended display mode requires a monitor that is Display Port capable to be connected to the DP2 port (bottom).

Note: We recommend rebooting the instrument after connecting an external touchscreen.

Turn on the extended display mode:

1. Select the **Settings** icon (⚙️) and then select **Display**.
2. Set the Extended Display Mode to **Enabled**.

Note: If the Extended Display Mode setting is turned off, the second display mirrors the primary display.

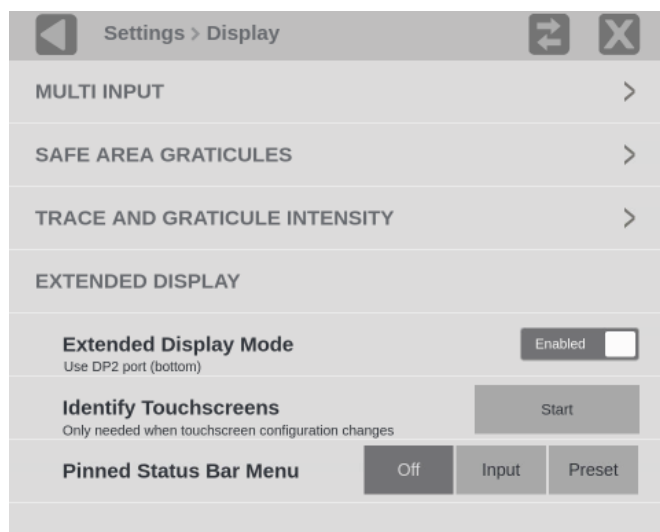

If the second display is touch-enabled, identify the locations of the displays.

1. Select **Start**.
2. Follow the on-screen instructions. When instructed to touch the primary and extended displays, make sure to use a touch gesture on the touchscreens and not a mouse. The touchscreens will not be properly identified if you use a mouse or if you configure remotely, such as with VNC.
3. If the displays appear to be non-responsive:
 - A. Connect a mouse to the instrument.
 - B. Select the **Home** icon () , then click **Settings**, and then click **Display**.
 - C. Select **Start**.

The displays are reset and respond to touch again.
4. Follow the on-screen instructions. Use touch to complete the steps; do not use the mouse.

Note: The process to identify the touchscreens can be performed again at any time. When the process completes successfully, it is not necessary to perform it again unless you change the touchscreen configuration, for example, if you change the USB port connections on the back of the instrument.

Note: When Extended Display Mode is turned on, the HDMI video port on the MPI2 is not available.

If needed, select a status bar for the extended display:

In Pinned Status Bar Menu select an option:

Off: No status bar is in the extended display.

Input: The Input status bar (the same status bar that appears when you select Input on the main display) appears in the extended display.

Preset: The Preset status bar (the same status bar that appears when you select Preset on the main display) appears in the extended display.

Note: When you select Input or Preset to pin to the extended display, that option is unavailable on the Status bar until it is unpinned from the extended display.

Configure MPX2 Displays

An MPX2 does not come with an internal display like other PRISMs. Monitors are needed depending on the number of application tiles in your workspace.

Note: Monitors with a 1920×1080 capable display works best with the instrument.

Note: We recommend rebooting the instrument after connecting an external touchscreen.

Display Mode

Display mode is the standard 4 usable tiles. A second monitor will duplicate the first monitor.

1. Make sure the MPX2 and monitor units are powered off.
2. Connect a Display Port-capable monitor or an HDMI-capable monitor to a Display Port or an HDMI port. Connect a second monitor if needed.
3. Power on all units.

Extended Display Mode

The extended display function requires software option MP2-EXTNDSP and a second monitor; it allows 8 usable tiles. Without the option the primary monitor is duplicated onto the second display.

Extended Display Mode requires either:

- two Display Port-capable monitors connected to the DP ports
or
- two HDMI-capable monitors connected to the DP ports with DP-to-HDMI adapters.

Set up Extended Display Mode:

1. Make sure the MPX2 and monitors are powered off.
2. Connect the MPX2 to the second monitor (or both monitors) and power on all units.

Note: The display mode will not function with one of each monitor type.

3. Select the **Settings** icon () and then select **Display**.

4. Set the Extended Display Mode to Enabled.

If the Extended Display Mode setting is turned off, the second display mirrors the Primary display.

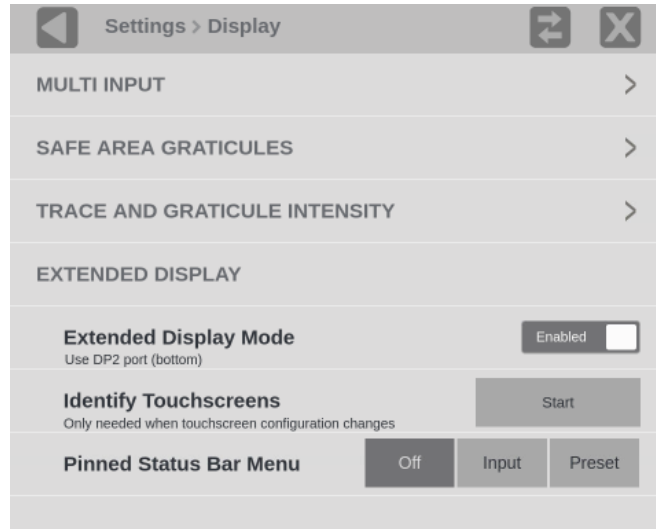

If the second display is touch-enabled, identify the locations of the displays.

1. Select **Start**.
2. Follow the on-screen instructions. When instructed to touch the Primary and Extended displays; make sure to use a touch gesture on the touchscreens and not a mouse.

Note: The touchscreens will not be properly identified if you use a mouse or if you configure remotely, such as with VNC.

If the displays appear to be non-responsive:

1. Connect a mouse to the instrument.
2. Select the **Home** icon (), then click **Settings**, and then click **Display**.
3. Select **Start**.
 The displays are reset and respond to touch again.
4. Follow the on-screen instructions. Use touch to complete the steps; do not use the mouse.

Note: The process to identify the touchscreens can be performed again at any time. When the process completes successfully, it is not necessary to perform it again unless you change the touchscreen configuration, for example, if you change the USB port connections on the back of the MPX2 instrument.

Note: When you connect an MPX2-DUALDSP to an MPX2 the first time, the second display might be blank until an application is selected from the press-and-hold menu.

If needed, select a status bar for the extended display:

1. Set Extended Display Mode to **Enabled**.

2. In Pinned Status Bar Menu select an option:

Off: No status bar is in the extended display.

Input: The Input status bar (the same status bar that appears when you select Input on the main display) appears in the extended display.

Preset: The Preset status bar (the same status bar that appears when you select Preset on the main display) appears in the extended display.

Note: When you select Input or Preset to pin to the extended display, that option is unavailable on the Status bar until it is unpinned from the extended display.

Remote Control Operation

The PRISM can be controlled through WebRTC, VNC, API commands, or NMOS. There is potential for connection loss unless the user takes certain steps. And the methods require a hostname or IP address and a password for the PRISM. This section explains how to avoid losing the connection and how to find the IP address and how to find and change the hostname and password.

Prevent Remote Connectivity Loss

Before setting a PRISM instrument for remote use, be aware, do not set the PRISM Control IP address to the subnet of any of the Video IP Ports (or the Video IP Ports subnet to the Control IP address) or all remote connectivity (VNC or API) can be lost. If connectivity is lost this way, you will need local access to the PRISM to correct it.

For more details on changing the port addresses, see [Connect to a Network](#).

Description of Connectivity Loss

When the Control IP address is set in the subnet of a Video IP Port, any request comes in on the Control port but the response is returned through Video IP Port 1, so the response is not sent back to the sender, even though the PRISM Control port received the request. The sender is not connected to a network reachable by the Video IP Port 1.

Example of Connectivity Loss

This is an example of port settings that can cause a loss of connectivity.

- Control IP Port: 172.19.133.12 / 24 (255.255.255.0)
- Video IP Port 1: 172.19.227.177 / 16 (255.255.0.0)

The Control IP Port address 172.19.133.12 is within the Video IP Port 172.19.xxx.xxx address.

Prevention of Connectivity Loss

This explains how to change a Subnet Mask / Prefix number without losing connectivity:

1. Disable the port:
 - A. Select the **Settings** icon () and then select **Network**.
 - B. Select the **VIDEO IP PORT** tab.
 - C. Change the Data Rate to the unselected option (if you are using a 10Gb rate, select 25Gb; if you are using 25Gb, select 10Gb).
2. In the Subnet Mask / Preset, select the up or down arrows to set the number to /30.

Note: The /30 is close to a link local address. It is unlikely to accidentally forward traffic to that interface; the Video IP Ports can remain active without interfering with Control Port traffic.

3. In the VIDEO IP PORT tab, reset the Data Rate back to the original rate.
4. If you made this change locally, test the remote connectivity is still available by logging on to the PRISM web page.

Find or Change Hostname, Password, and IP Address

This section explains how to find the hostname, password, and IP address of a PRISM. And it explains how and where to change the hostname and password.

Find Hostname

On the Status bar, the current hostname is under the Telestream logo.

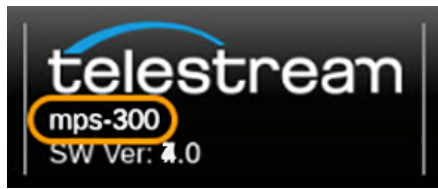

Change Hostname

1. On the PRISM monitor to connect to, select the **Settings** icon (⚙️).
2. Select **Network** and then select the **REMOTE ACCESS** tab.

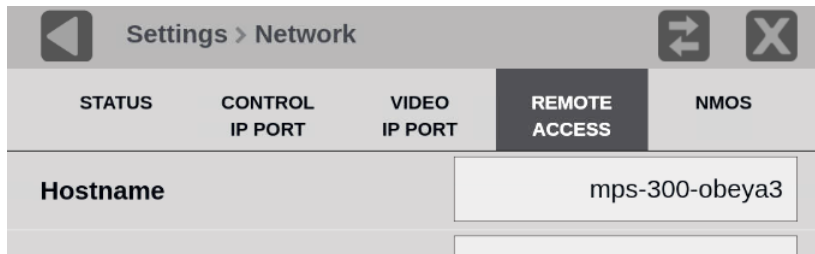

3. Select in the Hostname field and enter a new hostname with the remote keyboard or the on-screen keyboard.
4. Select **Save**.

Find and Change Password

1. On the PRISM monitor to connect to, select the **Settings** icon (⚙️).

2. Select **Network** and then select the **REMOTE ACCESS** tab.

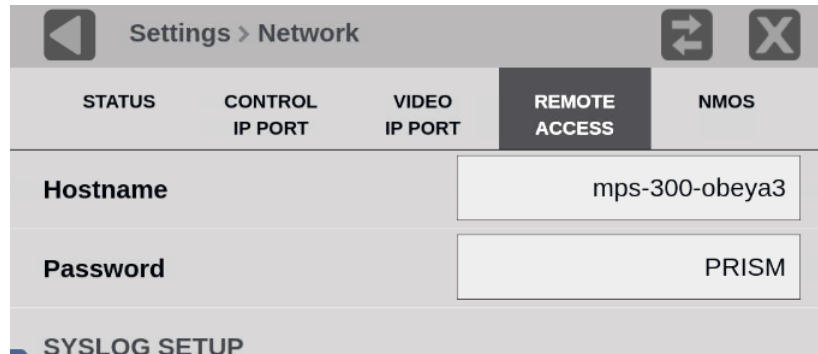

3. Select in the Password field and enter a new password with the remote keyboard or the on-screen keyboard.
4. Select **Save**.

Find IP Address

Note: The IP address can change but it is an automated action. It cannot be changed by the user.

1. On the PRISM monitor to connect to, select the **Settings** icon (⚙️).
2. Select **Network** and then select the **STATUS** tab. The IP Address of the instrument is under Control IP Port.

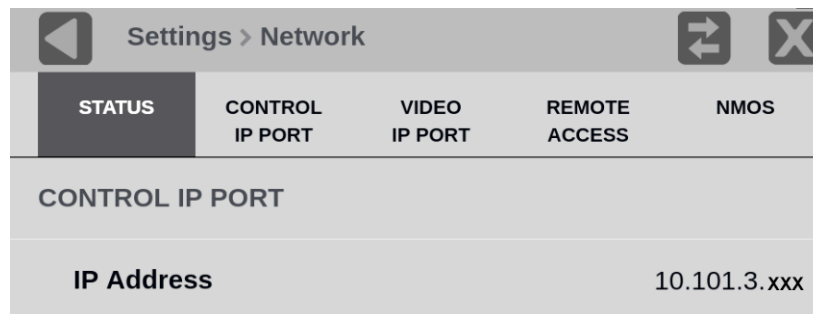

Remote Control through WebRTC

When the PRISM monitor is connected to an Ethernet network, you can use a computer connected to the same network to remotely control the instrument and listen to the audio through a web browser. Setting a remote connection has a point where is it possible to lose a connection that can only be corrected by direct, in-person access to the PRISM. To understand and prevent this problem, see [Prevent Remote Connectivity Loss](#).

Note: If you are using an MPI or MPX (not an MPI2 or MPX2) that is upgraded with a -25 multi-media board, the WebRTC capability is not supported. An MPI2-10 or MPX2-10 upgraded with a -25 multi-media board *does* support WebRTC.

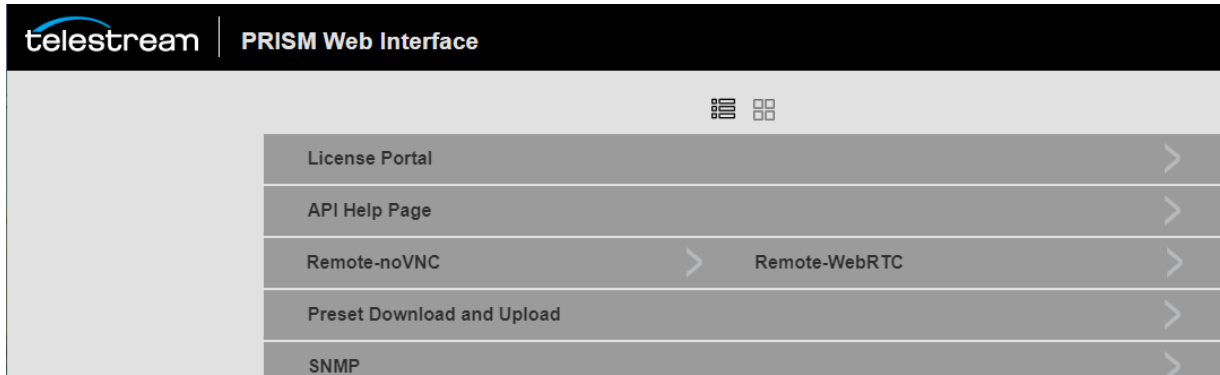

Connect with WebRTC

1. In a web browser, enter the hostname or IP address of the PRISM. See [Find or Change Hostname, Password, and IP Address](#).
When the PRISM is connected, the PRISM HOME page is displayed.
2. Select **Remote-WebRTC**.
A login web page displays.
3. Enter the password for that instrument in the Password field.
4. The User Name is for the WebRTC chat tool. Enter a name if needed.
5. Select **WebRTC Connect**.



Adjust WebRTC Settings

Select the WebRTC menu button at the top left of the tiles.

The WebRTC menu appears at the top of the tiles.

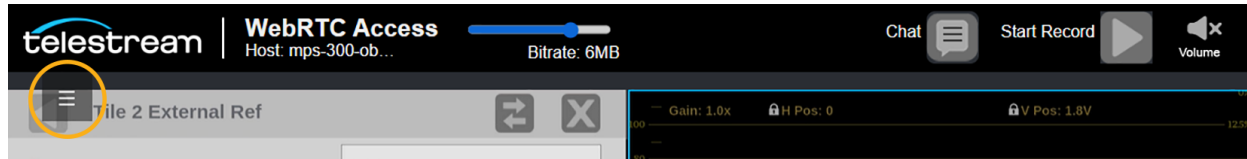

WebRTC Access

Displays the hostname of the instrument.

Bitrate

The slider control changes the bandwidth and fidelity of the images. If the data available (for example on a slow network) does not allow a smooth view of the PRISM information, adjust the Bitrate control. Start with Bitrate at 2 MB or less.

Any change to the Bitrate control changes the bitrate of all the users on the instrument.

Chat

Select to open a chat message window with other people using the PRISM through WebRTC. If you entered a user name when you logged in, it is shown in the chat window. If you did not enter a user name, a hexadecimal ID is shown.

Start Recording

Select to start and stop a recording of the screen and audio as it is presented on the PRISM. When recording is stopped, a .webm file is downloaded to the local computer in the downloads folder.

Volume

Select to turn the audio on and off. The WebRTC volume level is controlled with the computer volume controls.

Remote Control through VNC Operation

When the PRISM monitor is connected to an Ethernet network, you can use a computer connected to the same network to remotely control the instrument in a web browser or in VNC client such as VNC Viewer. Setting a remote connection has a point where is it possible to lose a connection that can only be corrected by direct, in-person access to the PRISM. To understand and prevent this problem, see [Prevent Remote Connectivity Loss](#).

To access 8 tiles remotely in an MPI2, it must be connected to a second display or a display emulator. To access 8 tiles remotely in an MPX2, it must either be connected to no displays or two displays.

Connect with VNC Client

When using VNC for extended periods of time, we recommend using a VNC client:

1. On an internet-connected computer, open a VNC client.
2. Enter the hostname or IP address from the instrument in the VNC Server search bar. See [Find or Change Hostname, Password, and IP Address](#).

The VNC client connects to the instrument in a separate window that appears exactly like the instrument display.

Connect with Web Browser

1. Enter the hostname or IP address from the instrument in a web browser. See [Find or Change Hostname, Password, and IP Address](#).

The PRISM HOME page displays.

2. Select **Remote noVNC Access**.

A noVNC page displays.

3. Select **Connect**.

A login page displays.

4. Enter the password for that instrument in the Password field and select **Send Credentials**.

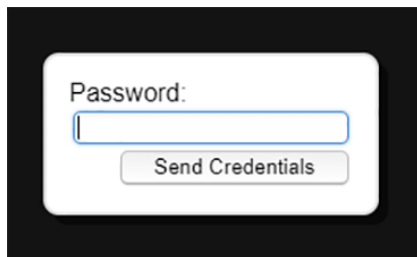

The image shows a screenshot of a web browser login form. It features a white rounded rectangle on a black background. Inside the rectangle, the text "Password:" is positioned above a text input field. Below the input field is a button labeled "Send Credentials".

To adjust the scale of the PRISM tiles (if the tiles do not all fit on the display):

1. In the PRISM web interface, select the control tab on the left side of the tiles to open the noVNC Settings.



2. Select the Settings icon.
3. In the Scaling Mode menu, select **Local Scaling**.
The tiles resize to fit the web browser window.

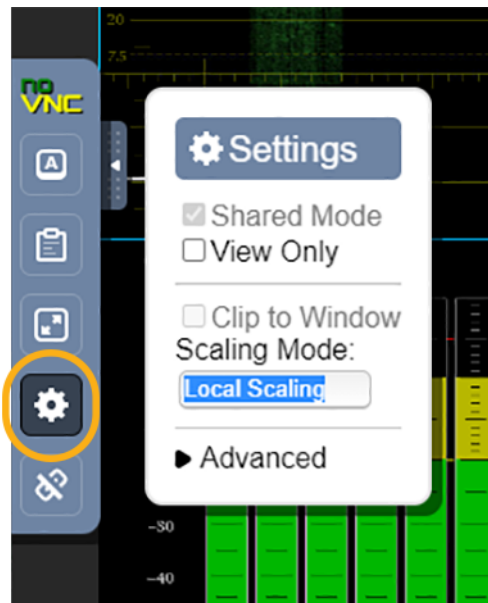

4. Select the Settings icon again to close the Settings menu.

Remote Control through API Commands

The PRISM monitor has a command set for controlling the instrument using REST-style API commands. You can use GET and POST commands to configure the signal inputs and to select the active input. Setting a remote connection has a point where it is possible to lose a connection that can only be corrected by direct, in-person access to the PRISM. To understand and prevent this problem, see [Prevent Remote Connectivity Loss](#).

1. Enter the hostname or IP address in a web browser. See [Find or Change Hostname, Password, and IP Address](#).

The PRISM HOME page displays.

2. Select **API Help Page**.

A PRISM API Documentation web page similar to the sample displays.

NAME	MODE	DATATYPE	DESCRIPTION
anc_session_control	GET / POST	ints	Reset anc session. Option: ANC_ENGINE_SESSION_CONTROL_RESET.
audio_ballistic	GET / POST	ints	Ballistic Type for Audio Bars. Available Options: AUDIO_BALLISTIC_PPM_1, AUDIO_BALLISTIC_PPM_2, AUDIO_BALLISTIC_TRUE_PEAK.
audio_program_level	GET / POST	floats	Set/Read audio program level. Valid range: Values from -31.0 through 0.0
audio_test_level	GET / POST	floats	Set/Read audio test level. Valid range: Values from -31.0 through 0.0
loudness_loud_level	GET / POST	floats	Loudness loud level, valid range is in between 0 to -31
loudness_quiet_level	GET / POST	floats	Loudness quiet level, valid range is in between 0 to -60
loudness_target_level	GET / POST	object	Loudness target levels as part of JSON Object. An example of Loudness target levels { "target" : Target threshold in LKFS (Loudness units). Valid Range is in between 0 to -31dB "target_low" : Relative Offset below the target level. (In Loudness Unit(LU)). Ranges from 0.0 to 10.0

Remote Control through NMOS

See [Enable NMOS](#) for details on NMOS remote control of the instrument.

Configure the Instrument

Most of the instrument settings are controlled using the Settings menu. To access the global settings menu, select the **Settings** icon () in the status bar. This section describes how to configure these instrument settings:

- Virtual inputs: [Configure and Select Virtual Inputs](#)
- HDR monitoring: [Configure Instrument for HDR/WCG Monitoring](#)
- PTP reference settings: [Configure Reference Settings](#)
- Presets: [Set and Recall Instrument Presets](#)
- Internal time and date: [Set Time and Date](#)
- Firmware upgrade: [Upgrade Instrument Firmware](#)
- Installed software and hardware versions: [Verify Firmware Upgrade](#)

Note: Some of the configuration settings require you to enter values. A USB keyboard can be used to enter these values instead of using the touchscreen keypad on the instrument.

Configure and Select Virtual Inputs

The PRISM monitor allows you to configure multiple virtual inputs.

Select **Settings**, and then select **Inputs** menu for options:

- [Configure SDI Inputs](#)
- [Configure IP Inputs](#) (this includes ST 2022-6 and 2110-20/30/31/40 and RTP streams)
- [Rename Virtual Input](#)

The input selection of the PRISM is displayed in the middle of the status bar. The first line is the user defined name and the second line is the format.



CAUTION: IGMP communications fail when the Video IP Ports are configured for the same IP Address.

Configure SDI Inputs

Note: SDI quad link for 4K or 8K is only available when software option MP2-FMT-4K or MP2-FMT-8K is present. If this option is not present, only a single-link input can be configured. SDI quad link for HD, SD, and 3G is always available.

Set SDI Input Configuration

1. Select the **Settings** icon () to open the Settings menu.
2. Select **Inputs** to open the inputs submenu.
3. Select an input and then select **SDI**.



Note: The virtual inputs can be given any name.

4. Select one of the two options:

- Select **Single** for the Input Configuration and select one of the four physical SDI inputs to monitor.

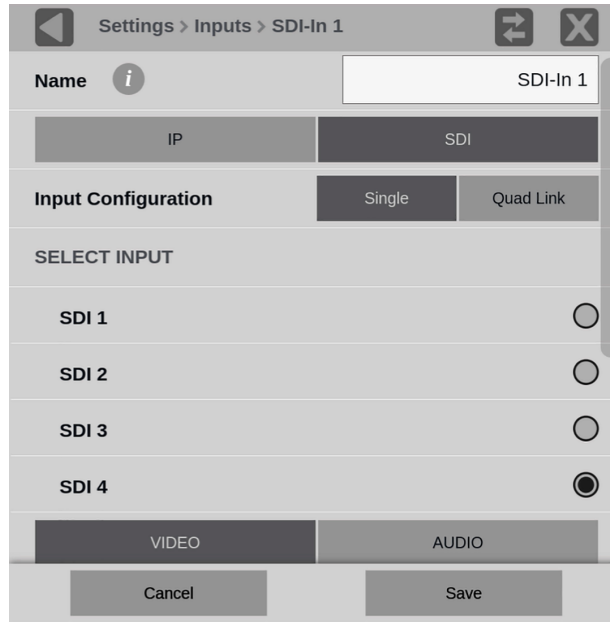

Or

- Select **Quad Link** for the Input Configuration and confirm that Quad Link cables are connected to the back of the instrument:
 - Quad Link A is connected to SDI-IN 1
 - Quad Link B is connected to SDI-IN 2
 - Quad Link C is connected to SDI-IN 3
 - Quad Link D is connected to SDI-IN 4

Note: All four SDI inputs must be connected to a cable on the back of the PRISM to use Quad Link Inputs.

5. In UHD/4K Mode, select from Auto, Sq Div (Square Division) or 2 SI (Two Sample Interleave).

SDI 1-4 (Link A-D) is selected by default.

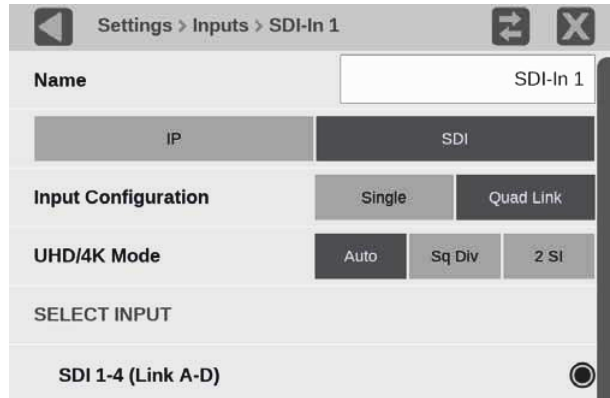

Note: The Quad Link and UHD/4K Mode buttons are only available when software option MP2-FMT-4K is present.

Note: In AUTO mode, the instrument defaults to Two Sample Interleave mode if the Video Payload Identifier (VPID) complies with ST 425.3 or ST 425.5. The instrument defaults to Square Division mode if the VPID complies with ST 292.1, ST 372, ST 425.1, or a quad-HD signal is present and VPID is missing. VPID in the signal is required for this option to operate properly.

Note: The 8K format trace applications—Waveform, Stop, Vector, Diamond, and Lightning Displays, enabled by MP2-FMT-8K—are rendered based on the resized 8K signal and are suitable for operational applications such as setting camera exposure for live programming. However, this approach may not be suitable for some engineering applications. This approach only impacts 8K formats and not SD/HD/3G/4K formats in either operations or engineering. 8K formats can use up to four trace applications.

Select SDI Video Settings

These settings are the same for Single and Quad Link input configurations. The Gamma and Color Gamut settings define the characteristics of the video signal.

Note: The preferred setting for all video options is Auto. At this setting the PRISM determines the correct settings from the signal or any metadata (if present).

1. Under SDI, select **Video**.

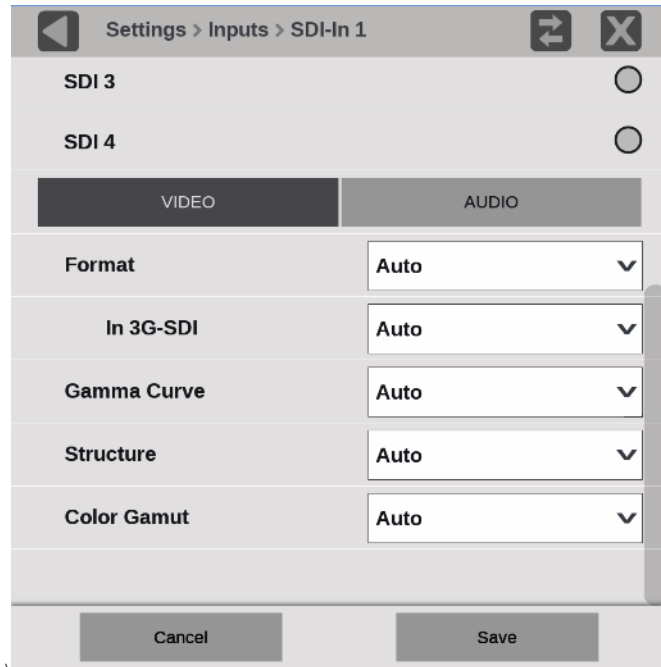

2. Choose the Format option from the menu:

- Auto:** The system selects the correct setting based on the information in the incoming signal.
- 525i
- 625i
- 720p
- 1080i
- 1080PsF
- 1080p
- 2048x1080p
- 3840x2160p
- 4096x2160p
- 7680x4320p

3. If a 3-gigabit transport is being used, select the In 3G-SDI menu and choose:

- Auto:** The system selects the correct setting based on the information in the incoming signal.
- Level A
- Level B

4. Select the Gamma Curve menu and select the option.

The selection characterizes the video signal on each virtual input.

- **Auto:** The system selects the setting based on ST 352 VPID. If 352 VPID is not present, SDR Narrow is selected.
- **SDR Narrow:** The reference OETF (Optical to Electrical Transfer Function) is defined in ITU-R BT.709 with gamma of 0.45 and the reference EOTF is defined in ITU-R BT.1886 with gamma of 2.4.

The Narrow scaling places the extremes of the nonlinear color value from zero to unity at code words 40 hex (64 dec) and 3AC hex (940 dec) in a 10bit representation for 0% Black to 100% White. This range is typical for standard-dynamic range.

- **SDR Full:** The reference OETF is defined in ITU-R BT.709 with gamma of 0.45 and the reference EOTF (Electrical to Optical Transfer Function) is defined in ITU-R BT.1886 with gamma of 2.4.

The full scaling places the extremes of the nonlinear color value from zero to unity at code words 0d and 1023d in 10bit representation and 0d and 4095d in 12-bit representation for 0% black and 100% white, respectively.

- **PQ Narrow:** The reference OETF with a high luminance range capability of 0 to 10,000 cd/m² standardized in ST 2084. The EOTF is the inverse of OETF.

The narrow scaling places the extremes of the nonlinear color value from zero to unity at code words 40 hex (64 dec) and 3AC hex (940 dec) in a 10bit representation for 0% Black to 100% White. This range is typical for standard-dynamic range.

- **PQ Full:** The reference OETF with a high luminance range capability of 0 to 10,000 cd/m² standardized in ST 2084. The EOTF is the inverse of OETF.

The full scaling places the extremes of the nonlinear color value from zero to unity at code words 0d and 1023d in 10-bit representation and 0d and 4095d in 12-bit representation for 0% black and 100% white, respectively.

- **HLG:** The reference OETF is standardized in ARIB B67 and the reference EOTF is standardized in ITU BT.2100 at the nominal display peak luminance of 1000 nits.
- **S-Log2:** The reference OETF is defined as Sony S-Log2.
- **S-Log3:** The reference OETF is defined as Sony S-Log3.
- **S-Log3 (Live HDR):** The reference OETF and OOTF (Optical to Optical Transfer Function) is defined as Sony S-Log3 (Live HDR).
- **Log C:** The reference OETF is defined as ARRI Log C.

5. Choose the Structure option from the menu:

- **Auto:** The system selects the correct setting based on ST 352 VPID. If 352 VPID is not present, YCbCr 4:2:2 10bit is selected.
- YCbCr 4:2:2 10bit
- YCbCr 4:2:2 12bit
- YCbCr 4:4:4 10bit
- RGB 4:4:4 10bit
- RGB 4:4:4 12bit

6. Choose the Color Gamut option from the menu.

This selects the color space of the video signal selection.

- **Auto:** The system selects the setting based on ST 352 VPID. If ST 352 VPID is not present, Rec. 709 is selected.
- **Rec. 709:** Standard for HD
- **Rec. 2020:** Standard for 4K

Note: Rec. 709 gamut is automatically selected when the SD format is detected / selected in the video signal.

Select SDI Audio Settings

The Audio settings define how the audio is embedded in the SDI input signal.

These settings are the same for Single and Quad Link input configurations, except the Quad Link, which is intended for 8K, can have 32 channels—instead of 16—in Program Configuration.

Set the SDI audio settings:

1. Under SDI, select **AUDIO**.



2. Configure one type of audio. See [Configure PCM](#), [Configure DOLBY](#), or [Configure DOLBY ED2](#) (use of Dolby or Dolby ED2 requires the MP2-DLBY license).

Configure PCM

- A. Under AUDIO, select **PCM**.
- B. Select **Program Configuration**.
The Prgm Cfg menu opens.
- C. Set the Program Configuration control to **On**.

D. Select Edit.

The Edit button disappears and the Default, Clear, and Undo buttons replace it.



Note: 8k (Quad Link) can have 32 channels instead of 16.

E. Select the type of program (mono, stereo, etc.) and select the audio channel to assign it. Repeat until all the audio in the current input signal have programs assigned to channels.

M is mono, 1 channel.

ST is stereo, 2 channels.

5.1 is surround sound, 6 channels.

To change the channel order in the audio bars, see [5.1 Channel Order](#).

7.1 is surround sound, 8 channels.

5.1.4 is immersive audio and requires 10 channels: 6 for the audio main bed, or level–marked in cyan, and 4 for the audio upper bed, marked in orange.

Note: 5.1.4 provides bar labels for the audio channels but is not available for downmix capability or for loudness display.



7.1.4 is immersive audio and requires 12 channels: 8 for the audio main bed, or level–marked in cyan, and 4 for the audio upper bed, marked in orange.

Note: 7.1.4 provides bar labels for the audio channels but is not available for downmix capability or for loudness display.

Unassigned removes an assignment from a channel. Select **Unassigned** and select any block in an assignment, for example select the middle of a 7.1 assignment, the entire assignment is removed and is not displayed on the Audio application.

Default resets the channels to 8 stereo pairs.

Clear removes all assignments, including the default.

F. Select **Save** and close the menu.

Note: You must save the program configuration to update the programs in the audio bars and loudness meter.

Configure DOLBY

Note: Dolby selection works with Dolby D, D Plus, or E signals.

A. Under AUDIO, select **DOLBY**.

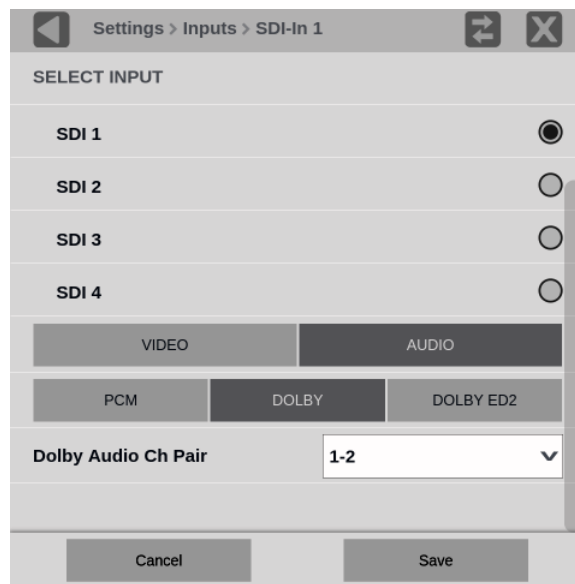

- B.** In the Dolby Audio Ch Pair menu, select the audio channel pair that contains Dolby audio.
- C.** If needed, identify Dolby Audio Channels, or go to step D:
- a.** Open the Audio application.
 - b.** Return to the Input menu and select the **PCM** option in Audio.

c. In the Audio application, in the audio levels, find and note the audio channels marked with either DOLBY D or DOLBY E.



d. In the Input menu, select the **DOLBY** option again.

e. In the Dolby Audio Ch Pair menu, select the channel pair that is marked as DOLBY in the Audio application.

The audio bar layout is automatically configured based on the metadata in the Dolby stream.

D. Select **Save** and close the menu.

Configure DOLBY ED2

A. Under AUDIO, select **DOLBY ED2**.



- B. In the Dolby ED2 Audio Ch Pairs menu, select the audio channel pairs that contains Dolby ED2 audio.
- C. If needed, identify Dolby ED2 audio channels, or go to step D:
 - a. In the Input menu, select **PCM** (instead of DOLBY ED2).
 - b. Open the Audio application.
 - c. In the Audio application, in the audio levels, find and note the audio channels marked with "DOLBY ED2."

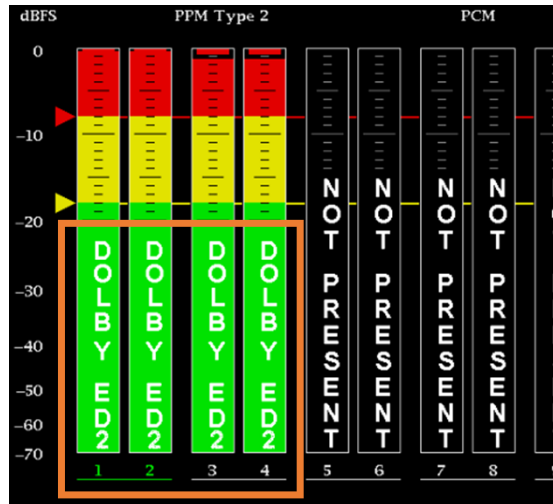

- d. In the Input menu, select the **DOLBY ED2** option (instead of PCM).
 - e. In the Dolby ED2 Audio Ch Pairs menu, select the channel pairs that are marked as DOLBY ED2 in the Audio application.
- Dolby ED2 metadata in the selected channels is decoded.

Note: When you select Dolby ED2 in the Input menu, the Audio application will stop presenting data. This is expected; only Dolby ED2 metadata is supported.

- D. Select **Save** and close the menu.

Note: Audio programs configured in the Program Configuration menu are used to select a program for measurement by the Loudness application, to display audio bars in the Audio application, and to monitor with headphones. When all the channels are unassigned, all the channels are treated as stereo pairs. The audio programs in the Dolby stream are automatically set up based on the Dolby metadata.

Rename Virtual Input

1. Select the **Settings** icon () to open the Settings menu.
2. Select **Inputs** to open the Inputs submenu.

3. Select an input and then select the Name field.
The text editing display opens.



4. Use the editing controls to enter a new name for the input. Some notes on using the text editor:
 - Enter a name with a maximum of 16 characters.
 - Select the Clear icon (X) next to the input box to remove the existing name. Use the **shift** key to access capital letters.
 - Use the **backspace** key to delete characters by backspacing over them.
 - Use the **123-abc** key to change between accessing letters and numbers/symbols.
5. Select **Enter**, and then select **Save**.

Configure IP Inputs

Configure Data Rate

1. Select the **Settings** icon (⚙️) to open the Settings menu.
2. Select **Network** to open the Network submenu.
3. Select **VIDEO IP PORT** tab to open the submenu.
4. Select the Data Rate option (10Gb or 25Gb). The Data Rate applies to both ports; both ports must be 10Gb or 25Gb.

Note: If the 25Gb button cannot be selected, the MP2-25GE license has not been installed.

5. If you are using a 25GE connection with RS-FEC, set FEC to **RS-FEC**.

Note: If the 25-GE signal from the switch does not match the PRISM in FEC setting, the IP Status Port displays a red X and 0.0 bps. This response is similar to a disconnected fiber cable.

PRISM does not support RS-FEC auto-negotiation, you may have to manually configure your switch to enable or disable RS-FEC.

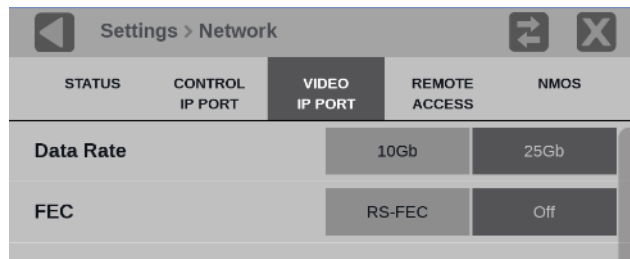

- If the instrument can read the multi-source agreement (MSA) data from the installed SFP module, the data rate of the SFP module and the optical wavelength is displayed in the SFP Module line.

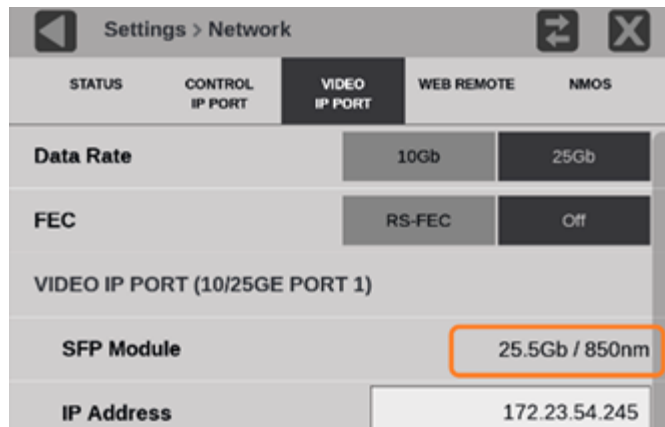

- If the SFP module speed does not match the Data Rate setting, instead of the data rate and frequency, the message "SFP not compatible with selected Data Rate." is displayed.
 If the SFP module does not have readable MSA data, instead of the data rate and frequency, the message "Unknown" is displayed.

Note: In the case of missing MSA data, the SFP Module line displays no compatibility warning regardless of what type of SFP module is installed or Data Rate setting. The instrument and the SFP module work if the SFP module matches the Data Rate setting.

- If no SFP module is installed, instead of data rate and frequency, the message "Disconnected" is displayed.

Possible status in the VIDEO IP PORT, SFP Module line

Type of SFP installed	Data Rate setting	
	10 Gb setting	25 Gb setting
SFP 25-Gb module	SFP not compatible...	(Data rate) / (frequency)
SFP 10-Gb module	(Data rate) / (frequency)	SFP not compatible...
Unreadable MSA data	Unknown	Unknown
No SFP installed	Disconnected	Disconnected

6. Select **RS-FEC** if Forward Error Correction (FEC) is needed. RS-FEC is specified by IEEE 802.3 Clause 91.

Note: FEC is only available when the Data Rate is set to 25Gb. FEC can only be selected for both ports. If it is on for one, it is on for both.

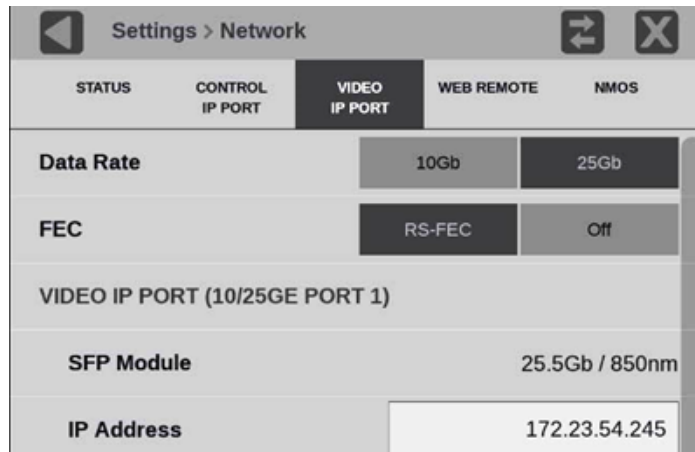

- The IP Status display shows the Data Rate setting, the FEC setting, and the signal status.

Note: If the Data Rate or FEC are incorrect, a red X appears on the left of the traffic bar, as when the fiber is disconnected.

- The Data Rate setting (10 or 25 Gb) is on the right of the network traffic bar.
- The FEC setting is below the data rate.
- The signal status is on the left of the network traffic bar.

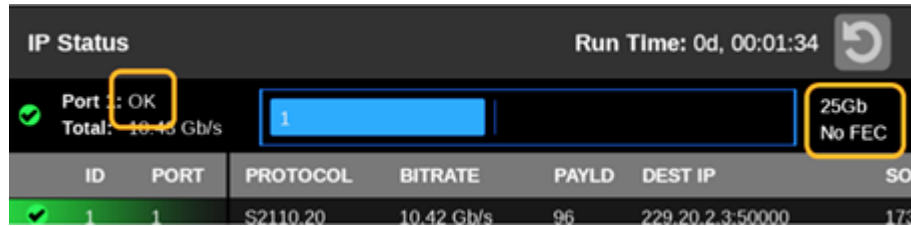

Possible status of the ports in IP Status

Type of SFP installed	Data rate setting	
	10Gb	25Gb
SFP 25-Gb module	SFP Mismatch	OK
SFP 10-Gb module	OK	SFP Mismatch
Unreadable MSA data	Unknown	Unknown
No SFP installed	Disconnected	Disconnected

7. If the IP Status Port displays “SFP Mismatch,” repeat steps 1 through 4 to confirm the Data Rate is set correctly and check the installed SFP module has the expected data rate.

Set ST 2022-6 Configuration

Note: If you are not using 2022-6, go to [Set ST 2110 Configuration](#).

1. Select the **Settings** icon (⚙️) to open the Settings menu.
2. Select **Inputs** to open the Inputs submenu.
3. Select the input from the list.

4. Select IP.



5. Under IP select **ST2022-6.**

6. Set the ST2022-7 Seamless Switching control to Enabled or Disabled.

Note: There is a difference between “port” and “path”. The port is the physical SFP port that is used to input the 10/25GE signal. Path 1 and Path 2 are the signal paths to be used for seamless switching. This distinction is important because Path 1 can also be configured to use Port 2.

Note: With ST2022-7 seamless switching, a reconstructed output stream is created from the two input streams. The reconstructed stream is used downstream for various display tiles like Picture. The buffer size to absorb the packet reception time difference between Path1 and Path2 is 10 ms. The output stream reconstruction does not work properly for streams on Path1 and Path2 with skew greater than 10 ms. This error makes tiles show the wrong images and information.

7. Enter the Source and Destination information for Path 1 and Path 2, if applicable.

Note: Path 2 is only available if ST2022-7 Seamless Switching is enabled. You may have to scroll down to see Path 2.

8. To have the instrument ignore a parameter, select the **Unmasked control next to the parameter to change the state to Masked.**

9. To edit one of the parameter values, select inside the parameter box to open the editing display.

An on-screen keypad appears.



10. When you are done editing, select **Enter**.
11. Scroll down to enter the Source and Destination information for Path 2.

Select ST 2022-6 Video Settings

The Gamma and Color Gamut settings are the same for ST 2022-6 and 2110 video stream configurations, but the 2110 menu has a different layout. The settings define the characteristics of the video signal.

1. Under ST2022-6 select **Video**.

2. Select the Gamma Curve menu and choose the setting.
The selection characterizes the video signal on each virtual input.

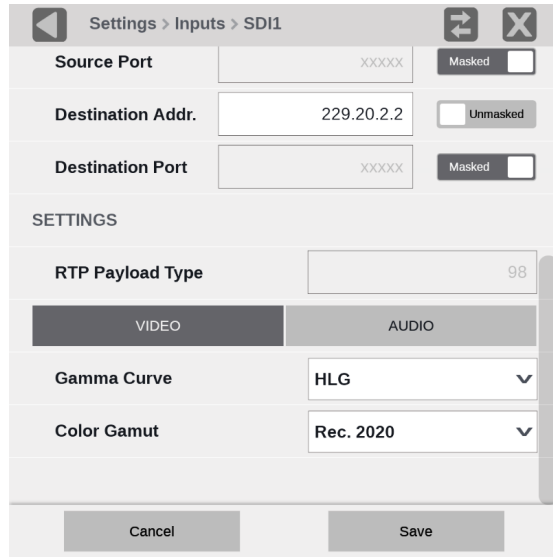

SDR Narrow: The reference OETF (Optical to Electrical Transfer Function) is defined in ITU-R BT.709 with gamma of 0.45 and the reference EOTF (Electrical to Optical Transfer Function) is defined in ITU-R BT.1886 with gamma of 2.4.

The Narrow scaling places the extremes of the nonlinear color value from zero to unity at code words 40 hex (64 dec) and 3AC hex (940 dec) in a 10bit representation for 0% Black to 100% White. This range is typical for standard-dynamic range.

SDR Full: The reference OETF is defined in ITU-R BT.709 with gamma of 0.45 and the reference EOTF is defined in ITU-R BT.1886 with gamma of 2.4.

The full scaling places the extremes of the nonlinear color value from zero to unity at code words 0d and 1023d in 10-bit representation and 0d and 4095d in 12-bit representation for 0% black and 100% white, respectively.

PQ Narrow: The reference OETF with a high luminance range capability of 0 to 10,000 cd/m² standardized in ST 2084. The EOTF is the inverse of OETF.

The narrow Scaling places the extremes of the nonlinear color value from zero to unity at code words 40 hex (64 dec) and 3AC hex (940 dec) in a 10bit representation for 0% Black to 100% White. This range is typical for standard-dynamic range.

PQ Full: The reference OETF with a high luminance range capability of 0 to 10,000 cd/m² standardized in ST 2084. The EOTF is the inverse of OETF.

The Full scaling places the extremes of the nonlinear color value from zero to unity at code words 0d and 1023d in 10bit representation and 0d and 4095d in 12-bit representation for 0% black and 100% white, respectively.

HLG: The reference OETF is standardized in ARIB B67 and the reference EOTF is standardized in ITU BT.2100 at the nominal display peak luminance of 1000 nits.

S-Log2: The reference OETF is defined as Sony S-Log2.

- **S-Log3**: The reference OETF is defined as Sony S-Log3.
- **S-Log3 (Live HDR)**: The reference OETF is defined as Sony S-Log3.
- **Log C**: The reference OETF is defined as ARRI Log C.

3. Select Color Gamut settings in the menu.

The selection is the color space of the video signal.

- **Rec. 709**: Standard for HD.
- **Rec. 2020**: Standard for 4K.

Note: Rec. 709 gamut is automatically selected when the SD format is detected or selected in the video signal.

Select ST 2022-6 Audio Settings

1. Under ST2022-6 select **AUDIO**.

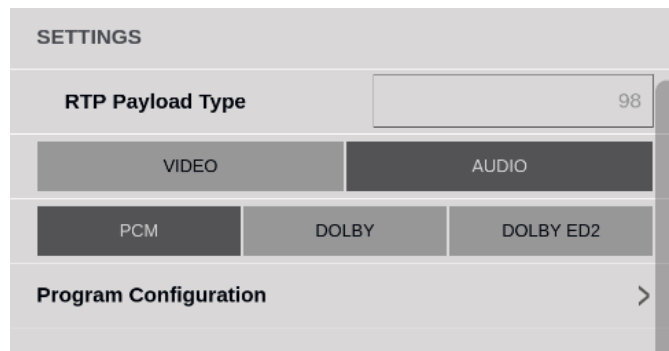

2. Configure one type of audio. See [Configure PCM](#), [Configure DOLBY](#), or [Configure DOLBY ED2](#) (use of Dolby requires the MP2-DLBY license).

Configure PCM

- Under AUDIO, select **PCM**.
- Select **Program Configuration**.
- Set the Program Configuration control to **On**.

D. Select Edit.

The Edit button disappears and the Default, Clear, and Undo buttons replace it.



E. Select the type of program (mono, stereo, etc.) and select the audio channel to assign it. Repeat until all the audio in the current input signal have programs assigned to channels.

M is mono, 1 channel.

ST is stereo, 2 channels.

5.1 is surround sound, 6 channels.

To change the channel order in the audio bars, see [5.1 Channel Order](#).

7.1 is surround sound, 8 channels.

5.1.4 is immersive audio and requires 10 channels: 6 for the audio main bed, or level–marked in cyan, and 4 for the audio upper bed, marked in orange.

Note: 5.1.4 provides bar labels for the audio channels but is not available for downmix capability or for loudness display.

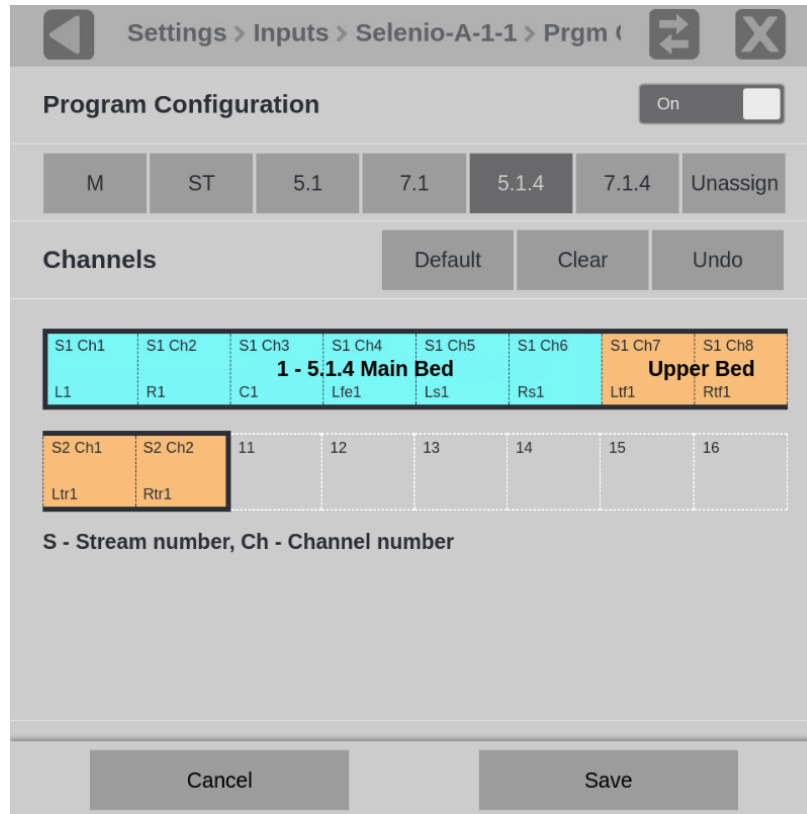

7.1.4 is immersive audio and requires 12 channels: 8 for the audio main bed, or level–marked in cyan, and 4 for the audio upper bed, marked in orange.

Note: 7.1.4 provides bar labels for the audio channels but is not available for downmix capability or for loudness display.

Unassigned removes an assignment from a channel. Select **Unassigned** and select any block in an assignment, for example select the middle of a 7.1 assignment and the entire assignment is removed and is not displayed on the Audio application.

Default resets the channels to 8 stereo pairs.

Clear removes all assignments, including the default.

F. Select **Save** and close the menu.

Note: You must save the program configuration to update the programs in the audio bars and loudness meter.

Configure DOLBY

Note: Dolby selection works with Dolby D, D Plus, or E signals.

A. Under AUDIO, select **DOLBY**.



- B.** In the Dolby Audio Ch Pair menu, select the audio channel pair that contains Dolby audio.
- C.** If needed, identify Dolby Audio Channels, or go to step D:
- a.** Open the Audio application.
 - b.** Return to the Input menu and select the **PCM** option.

- c. In the Audio application, in the audio levels, find and note the audio channels marked with either DOLBY D or DOLBY E.



- d. In the Input menu, select the **DOLBY** option again.
- e. In the Dolby Audio Ch Pair menu, select the channel pair that is marked as DOLBY in the Audio application.

The audio bar layout is automatically configured based on the metadata in the Dolby stream.

D. Select **Save** and close the menu.

Note: Audio programs configured in the Program Configuration menu are used to select a program for measurement by the Loudness application, to display audio bars in the Audio application, and to monitor with headphones. When all the channels are unassigned, all the channels are treated as stereo pairs. The audio programs in the Dolby E stream are automatically set up based on the Dolby D/D Plus/E metadata.

Configure DOLBY ED2

A. Under AUDIO, select **DOLBY ED2**.

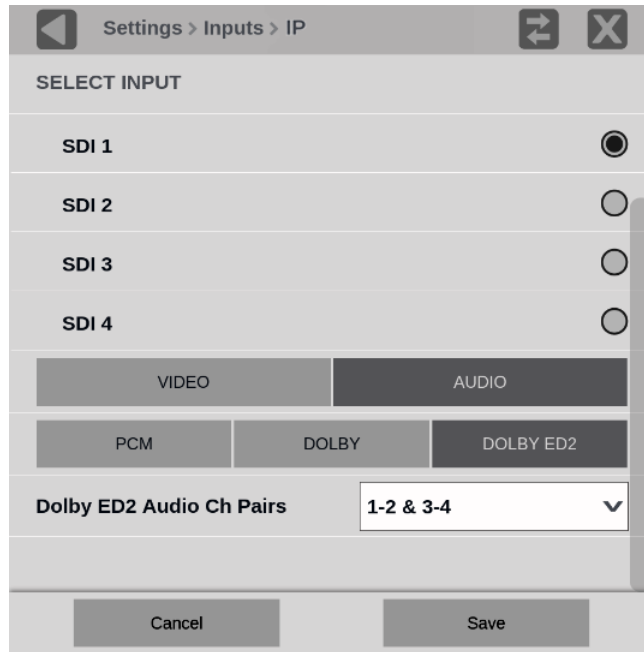

B. In the Dolby ED2 Audio Ch Pairs menu, select the consecutive channel pairs that contains Dolby ED2 audio.

C. If needed, identify the Dolby ED2 audio channels, or go to step D:

a. In the Input menu, select **PCM** (instead of DOLBY ED2).

b. Open the Audio application.

c. In the Audio application, in the audio levels, find and note the audio channels marked with "DOLBY ED2".

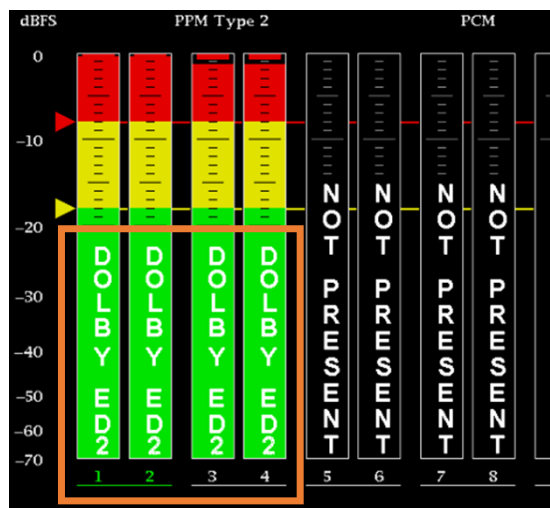

d. In the Input menu, select the **DOLBY ED2** option (instead of PCM).

- e. In the Dolby ED2 Audio Ch Pairs menu, select the channel pairs that are marked as DOLBY ED2 in the Audio application.

Dolby ED2 metadata in the selected channels is decoded.

Note: When you select Dolby ED2 in the Input menu, the Audio application will stop presenting data. This is expected; only Dolby ED2 metadata is supported.

- D. Select **Save** and close the menu.

Set ST 2110 Configuration

Note: If you are not using 2110, go to [Set ST 2022-6 Configuration](#).

1. Select the **Settings** icon () to open the Settings menu.
2. Select **Inputs** to open the inputs submenu.
3. Select an input from the list.
4. Select **IP** and then select **ST2110**.
5. Set the NMOS control to Enabled or Disabled as needed.

Enabling NMOS allows system management software to discover, register, configure the input, and select the active input for monitoring.

Note: NMOS Discovery and Registration must be enabled in the network settings for this control to be available. (See [Enable NMOS](#).)

For details on using persistent NMOS, see [Enable Persistent NMOS](#).

6. Set the Seamless Switching control to Enabled or Disabled as needed.

Note: For Seamless Switching, the two Path 1 and Path 2 streams should be identical. If the streams are not identical, error messages are shown in the Status Bar. There is a difference between “port” and “path”. The port is the physical SFP port that is used to input the 10GE signal. Path 1 and Path 2 are the signal paths to be used for seamless switching.

Note: With Seamless Switching, a reconstructed output stream is created from the two input streams. The reconstructed stream is used downstream for various display tiles like Picture. The buffer size to absorb the packet reception time difference between Path1 and Path2 is 10 ms. The output stream reconstruction does not work properly for streams on Path1 and Path 2 with skew greater than 10ms. This error makes Picture tiles show the wrong image.

Configure Video (2110-20) Stream

Note: Incoming 10-bit ST 2110-20 data is supported in the range 4-1019. Incoming data below the minimum is reduced to 4 and data above the maximum is reduced to 1019.

1. Under ST2110, select the **Video** tab.
2. Set the Enable Video control to **Enabled**.

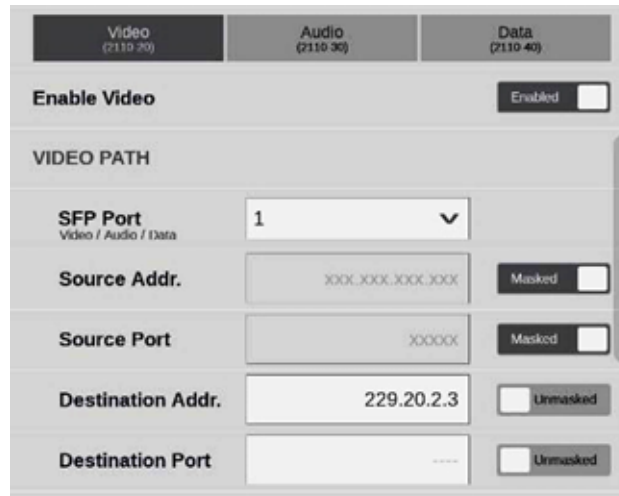

3. Enter the information in SFP Port, Source Addr, Source Port, Destination Addr., and Destination Port for each video stream.
If any fields are inaccessible (gray), set the Masked-Unmasked option to **Unmasked**.
4. Set Ignore RTP Sequence Errors to **On** if needed.
This setting causes the instrument to ignore errors caused by out-of-order RTP packets; no events are generated. This is useful if incoming RTP packets are deliberately out of sequence.
5. Set the RTP Payload Type between 96 and 127.
6. Set the Packet Read Schedule (PRS) to Gapped, Narrow Linear, or Wide Linear to correctly measure the CMAX and VRX buffer measurements in the IP graphs.

Note: The PIT Histogram can be used to determine if the signal is a gapped, narrow-linear, or wide-linear stream.

7. Set the TR Offset, which defines the timing reference offset of the sender for network delays. Select Auto to provide an offset based on the current video standard.

8. Select the Gamma Curve and Color Gamut settings for the video stream. For details on Gamma and Gamut selections, see [Select the Gamma Curve menu and choose the setting.](#)

VIDEO SETTINGS	
Ignore RTP Sequence Errors	<input type="checkbox"/> Off
RTP Payload Type	96
Packet Read Schedule (PRS)	<input checked="" type="radio"/> Gapped <input type="radio"/> Narrow Linear <input type="radio"/> Wide Linear
TR Offset (μs)	<input type="text" value="Auto"/> <input type="checkbox"/> Auto
Gamma Curve	SDR Narrow ▼
Color Gamut	Rec. 709 ▼

9. If needed, set the Format Detection to **Manual**.

Note: Manual Format Detection is required for 2110 Fast Switching. See [Set for 2110 Fast Switching.](#)

10. Select the Resolution field and set the resolution.
11. Select the Frame Rate field and set the frame rate.
12. If the Structure option is available, select the field to change to RGB 4:4:4 12bit as needed.

Note: Only some of the resolutions and frame rates allow the Structure to be RGB 4:4:4 12bit.

Gamma Curve	HLG
Color Gamut	Rec. 2020
Format Detection	Manual <input type="checkbox"/>
Resolution	1920x1080
Frame Rate	59.94p
Structure	YCbCr 4:2:2 10bit

Buttons: Cancel, Save

13. Select **Save** to save the options you selected.

Configure Audio (2110-30 / 31) Stream

Note: To decode Audio (2110-30 / 31) stream, it's necessary for Video (2110-20) to be available and subscribed.

Note: Audio programs must be in a single audio stream for loudness, downmix, and surround display.

1. Under ST2110, select the **Audio (2110-30 / 31)** tab.
2. Select anywhere in the stream # row to configure (1-4).

Video (2110-20)	Audio (2110-30 / 31)	Data (2110-40)
Audio Streams		4
Stream 1 ST2110-30	P1- Dst: 239.30.10.19 : Masked Type: 97 CH: 2 Mapped	>
Stream 2 ST2110-31	P1- Dst: 239.31.10.19 : Masked Type: 101 CH: 2 Mapped	>
Stream 3 ST2110-30	Not Enabled Not Mapped	>
Stream 4 ST2110-30	Not Enabled Not Mapped	>

3. Set the Enable Audio Stream control to **Enabled**. This subscribes the audio stream from the media switch.
4. Set the Map Stream # control to **Enabled**. This makes the audio stream appear in the Audio applications.
5. Set audio transport protocol; select 2110-30 or 2110-31 in Audio Transport.

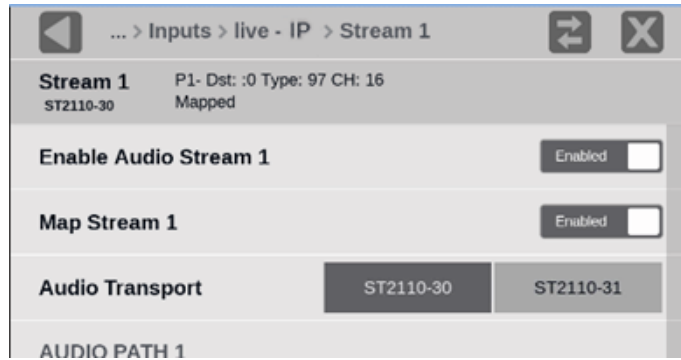

Note: 2110-30 or 2110-31 can carry PCM or Dolby D, D Plus, or Dolby E, but if 2110-30 will carry Dolby content, the data must be transmitted in pairs and set to start on odd channels such as 1-2 or 3-4.

Note: Only a single stream may be set for 2110-31; 1 to 4 streams may be 2110-30, up to a total of 4 audio streams, with a maximum of 16 audio channels total.

6. Select the number in SFP Port.

Note: The SFP (physical) Port configuration is common for Video, Audio, and Data.

7. Enter the address in the Destination Addr. field.

Note: The Source Addr, Source Port, and Destination Port are optional if the IP stream is uniquely specified.

AUDIO PATH 1		
SFP Port <small>Video / Audio /Data</small>	1	
Source Addr.	xxx.xxx.xxx.xxx	Masked <input type="checkbox"/>
Source Port	xxxxx	Masked <input type="checkbox"/>
Destination Addr.	239.31.10.19	Unmasked <input type="checkbox"/>
Destination Port	xxxxx	Masked <input type="checkbox"/>

8. Set the RTP Payload Type between 96 and 127.

Note: The RTP Payload Type is displayed in the IP Status application.

9. Set the number of channels in the audio stream between 2 and 16. The number of channels must be an even number (2, 4, 6, etc.). A maximum of 16 audio channels, across all audio streams, are supported.

10. Set Packet Timing as needed; Auto is recommended.

Note: If an audio programs uses multiple streams, all streams must have the same packet timing.

Note: The Bit Depth is already set to 24.

Note: If you are using an MPI or MPX (not an MPI2 or MPX2) that is upgraded with a 25G multi-media board, some audio functions (surround display, loudness, headphone downmix) are not available if the audio program uses (spans) multiple streams.

11. Select Save Stream #.

12. Repeat steps 1-10 for each stream to configure. You may configure from 0 to 4 audio streams as required, maintaining a total of 16 audio channels.

13. Under Audio (2110-30 / 31) configure one type of audio. See [Configure PCM](#), [Configure DOLBY](#), or [Configure DOLBY ED2](#): (use of Dolby requires the MP2-DLBY license).

Configure PCM

- A.** Under AUDIO, select **PCM**.
- B.** Select **Program Configuration**.
 The Prgm Cfg menu opens.
- C.** Set the Program Configuration control to **On**.

D. Select Edit.

The Edit button disappears and the Default, Clear, and Undo buttons replace it.

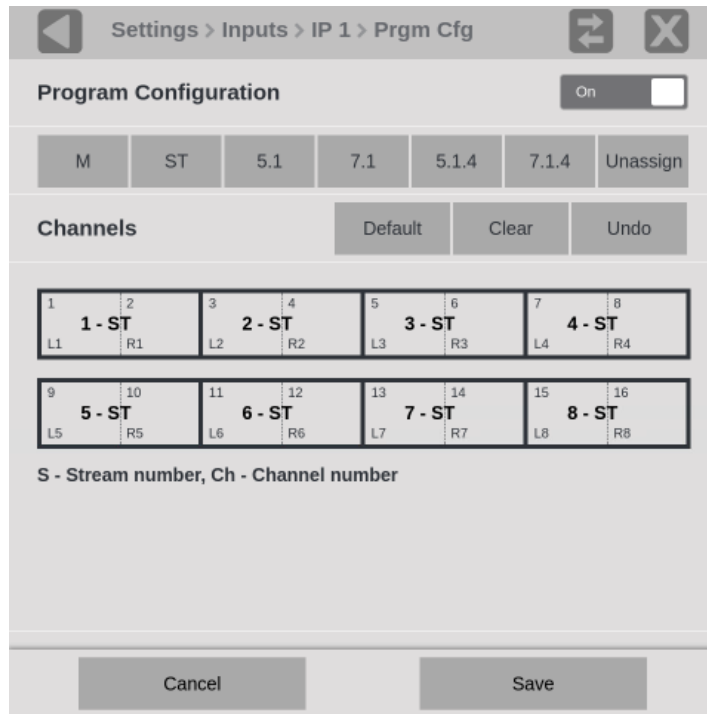

E. Select the type of program (mono, stereo, etc.) and select the audio channel to assign it. Repeat until all the audio in the current input signal have programs assigned to channels.

M is mono, 1 channel.

ST is stereo, 2 channels.

5.1 is surround sound, 6 channels.

To change the channel order in the audio bars, see [5.1 Channel Order](#).

7.1 is surround sound, 8 channels.

5.1.4 is immersive audio and requires 10 channels: 6 for the audio main bed, or level–marked in cyan, and 4 for the audio upper bed, marked in orange.

Note: 5.1.4 provides bar labels for the audio channels but is not available for downmix capability or for loudness display.

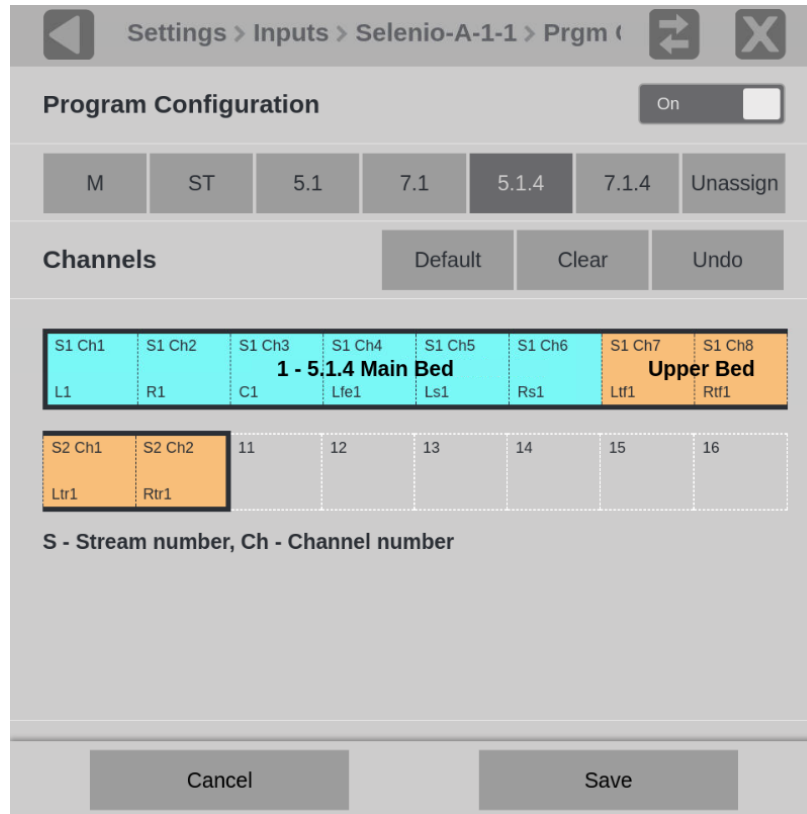

7.1.4 is immersive audio and requires 12 channels: 8 for the audio main bed, or level–marked in cyan, and 4 for the audio upper bed, marked in orange.

Note: 7.1.4 provides bar labels for the audio channels but is not available for downmix capability or for loudness display.

Unassigned removes an assignment from a channel. Select **Unassigned** and select any block in an assignment, for example the middle of a 7.1 assignment, the entire assignment is removed and is not displayed on the Audio application.

Default resets the channels to 8 stereo pairs.

Clear removes all assignments, including the default.

F. Select **Save** and close the menu.

Note: You must save the program configuration to update the programs in the audio bars and loudness meter.

G. If necessary to continue configuring the instrument, see [Configure Data \(2110-40\) Stream](#).

Configure DOLBY

Note: Dolby selection works with Dolby D, D Plus, or E signals.

Note: To use Dolby in 2110, the Audio Transport, in the audio stream, must be configured as 2110-31.

A. Under AUDIO, select **DOLBY**.

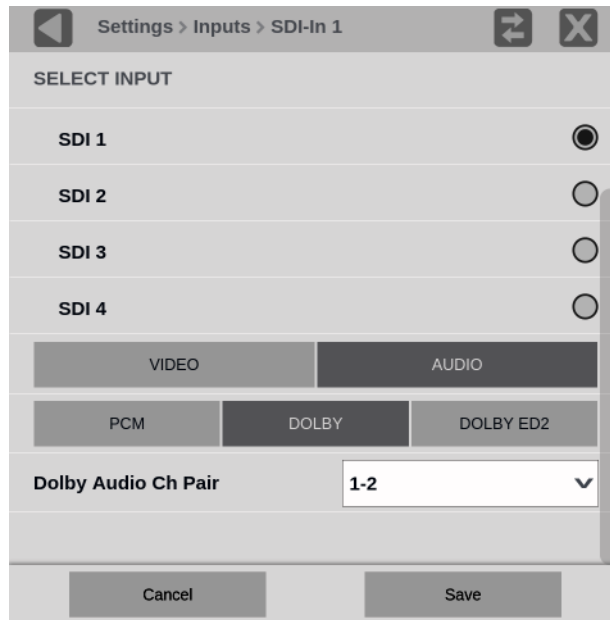

B. In the Dolby Audio Channel Pair menu, select the audio channel pair that contains Dolby audio.

C. If needed, identify Dolby Audio Channels, or go to step D:

a. Open the Audio application.

b. Return to the Input menu and select the **PCM** option.

- c. In the Audio application, in the audio levels, find and note the audio channels marked with either DOLBY D or DOLBY E.



- d. In the Input menu, select the **DOLBY** option again.
- e. In the Dolby Audio Ch Pair menu, select the channel pair that is marked as DOLBY in the Audio application.

The audio bar layout is automatically configured based on the metadata in the Dolby stream.

D. Select **Save** and close the menu.

Note: Audio programs configured in the Program Configuration menu are used to select a program for measurement by the Loudness application, to display audio bars in the Audio application, and to monitor with headphones. When all the channels are unassigned, all the channels are treated as stereo pairs. The audio programs in the Dolby E stream are automatically set up based on the Dolby E metadata.

Note: The number of audio streams and channels determines the content and order of audio channels embedded in the AUX OUT.

Note: If the number of audio channels present does not complete a group (4 channels) the remaining channels in the group will be labeled "Z BIT".

Note: If the audio bars are flashing in the audio display, or sounds are garbled or the wrong pitch, it is possible that the audio input configuration is not set up correctly. Check the IP address, port, and payload type from the IP session display and make sure to select the correct number of audio channels. A guideline for the number of audio channels (assuming 24-bit, 48-khz audio) is approximately 1 to 1.5 Mb/s per channel. See the IP Status BITRATE column.

Note: To receive only audio, disable the video stream.

- E. If necessary to continue configuring the instrument, see [Configure Data \(2110-40\) Stream](#).

Configure DOLBY ED2:

- A. Under AUDIO, select **DOLBY ED2**.

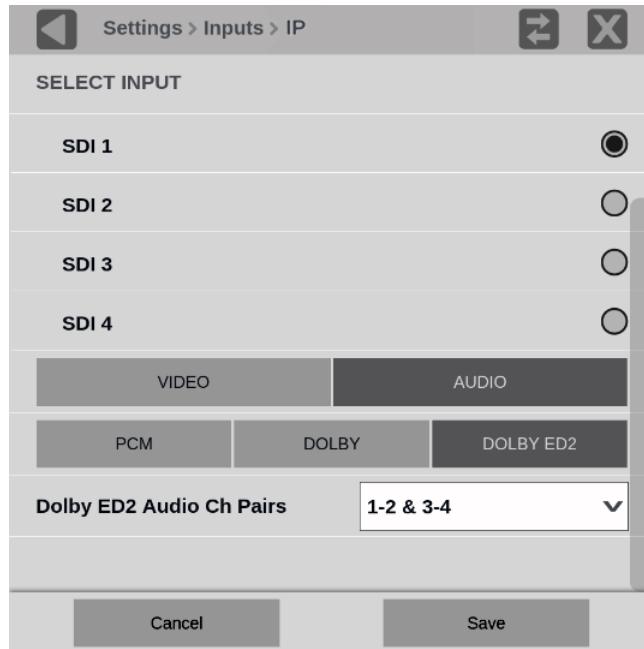

- B. In the Dolby ED2 Audio Ch Pairs menu, select the audio channel pairs that contains Dolby ED2 audio.
- C. If needed, identify the Dolby ED2 audio channels, or go to step D:
 - a. In the Input menu, select **PCM** (instead of DOLBY ED2).
 - b. Open the Audio application.

- c. In the Audio application, in the audio levels, find and note the audio channels marked with "DOLBY ED2".

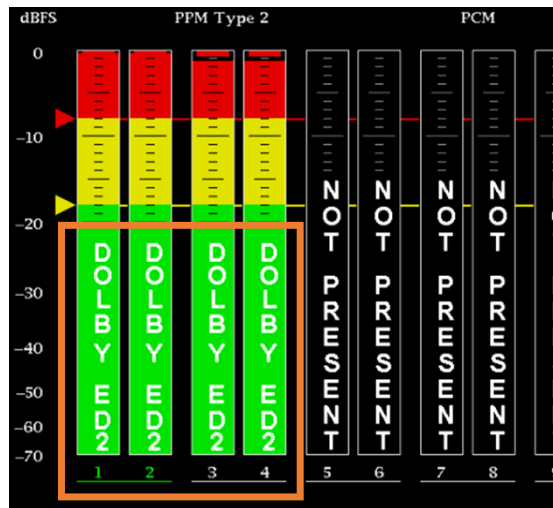

- d. In the Input menu, select the **DOLBY ED2** option (instead of PCM).
- e. In the Dolby ED2 Audio Ch Pairs menu, select the channel pairs that are marked as DOLBY in the Audio application.
Dolby ED2 metadata in the selected channels is decoded.

Note: When you select Dolby ED2 in the Input menu, the Audio application will stop presenting data. This is expected; only Dolby ED2 metadata is supported.

- D. Select **Save** and close the menu.
- E. If necessary to continue configuring the instrument, go to the next section.

Configure Data (2110-40) Stream

1. Select the **Data** tab.
2. Set the Enable Data control to **Enabled**.

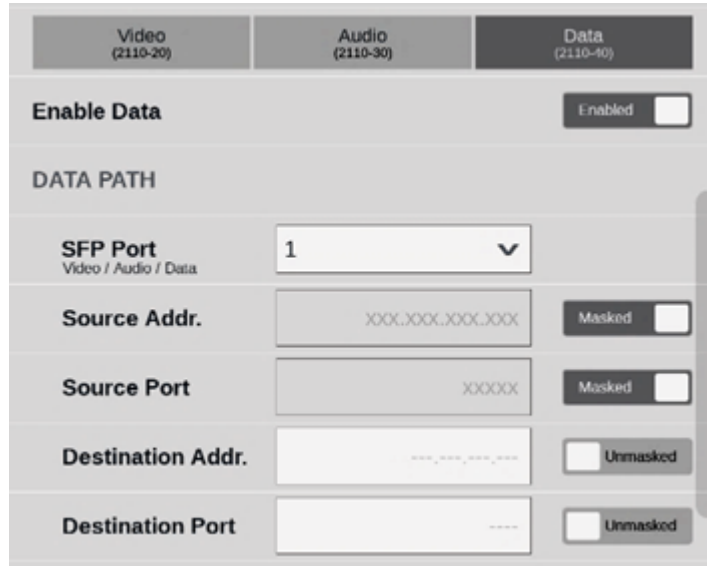

3. Enter the information in SFP Port, Source Addr, Source Port, Destination Addr., and Destination Port for each data stream.
4. Set the RTP Payload Type between 96 and 127.

Note: The RTP Payload Type number must be unique for each IP stream. The RTP Payload Type is displayed in the IP Status application.

5. Select **Save** and close the menu.

Configure RTP

Monitoring general purpose RTP streams allows you to see physical and IP layer measurements, but none of the video, audio, and data payload is decoded and displayed.

Monitor general purpose RTP streams:

1. Select the **Settings** icon () to open the Settings menu.
2. Select **Inputs** to open the Inputs submenu.
3. Select the input from the list.

4. Select **IP** and then select **RTP**.

The screenshot shows a configuration window titled 'Settings > Inputs > SDI1'. At the top, there is a 'Name' field containing 'SDI1'. Below this, there are two main tabs: 'IP' and 'SDI'. Under the 'IP' tab, there are three sub-options: 'ST2022-6', 'ST2110', and 'RTP', with 'RTP' being the selected option. The 'SFP Port' is set to '1'. The 'Source Addr.' field contains 'xxx.xxx.xxx.xxx' and has a 'Masked' checkbox. The 'Source Port' field contains 'xxxxx' and has a 'Masked' checkbox. The 'Destination Addr.' field contains '229.20.2.2' and has an 'Unmasked' checkbox. The 'Destination Port' field contains '50011' and has an 'Unmasked' checkbox. At the bottom, there are 'Cancel' and 'Save' buttons.

5. In SFP Port select the port to monitor.
6. Enter Source and Destination information.
7. Set the RTP Payload Type between 0 to 127.
8. Select the Video Format and corresponding Frame Rate.
9. Select **Save** and close the menu.

Select Input

Two modes are supported:



Single Input mode: Select any single input to monitor from an IP or SDI signal.

Multi-input mode: Select multiple SDI inputs to simultaneously monitor up to 4 SDI input. Option MP2-MULTI is required.

Single Input Mode

To select a single configured input from an IP or SDI signal:

Note: If the MP2-MULTI option is not installed, multiple inputs is not available, "Multi:" is not in the Input menu, and only single input mode is available.

1. Check the Single Input mode is enabled:
 - A. Select the **Settings** icon (), and then select **Input**.
 - B. Set Multi Mode to **Off**.
2. Select the **Input** icon () from the Status bar at the bottom of the PRISM monitor.

3. Select a configured input from the list in the Input bar.



4. Select the **Home** icon () to close the Input selection controls.

Multiple Inputs Mode

Multi-Input mode can simultaneously monitor up to 4 SDI inputs. When using Multi-Input mode there is a primary channel and up to 3 secondary channels

Primary Channel

The primary channel is the main input of the four possible inputs. It can be reassigned at any time. The current primary channel is marked in the Multi Input menu and the status bar with a cyan dot.

Alarms, Audio Output, and SDI Aux are only supported for the primary channel.

Secondary Channels

The secondary channels are any selected channel that is not the primary. These are marked in the multi-input menu and status bar with white dots. These inputs cannot be displayed in primary-only applications but are displayed in all other applications unless otherwise noted. If a secondary channel is assigned to a tile with a primary-only application (or a secondary channel is assigned a primary-only application), the tile displays a message that it cannot display the application on a secondary channel.

To select multiple SDI inputs:

1. Select the **Input** icon () from the Status bar at the bottom of the PRISM monitor.
2. Select the multi-input menu button from the Input bar.

Note: If "Multi:" is not in the Input menu and the Multi menu button is not active, the MP2-MULTI option might not be installed.



3. Set Multi Input to **ON**.

4. Set Edit Mode to ON.

When Edit mode is OFF:

- No individual input menus appear when you select an input button.
- Selecting an input applies the selected input without confirmation.
- Selecting an input changes that input to the primary channel.
- The options in the multi-input menu are not available (the inputs in the tiles and the selected channels cannot be changed).

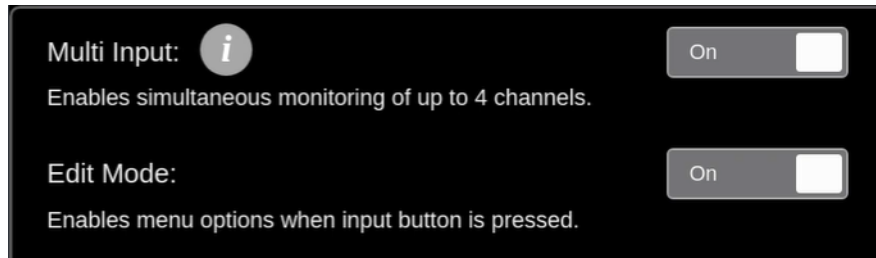

5. Assign inputs to one of four channels:

Note: If no channels have been selected, the first SDI input (left channel on the Input menu) is automatically set as the primary and shown on all the tiles.

A. Select an input from the Input bar.

The input menu opens.

B. In the menu, select **Add Channel.**

The example shows SDI-In 1 is the primary channel (cyan dot) and SDI-In 2 is unselected.

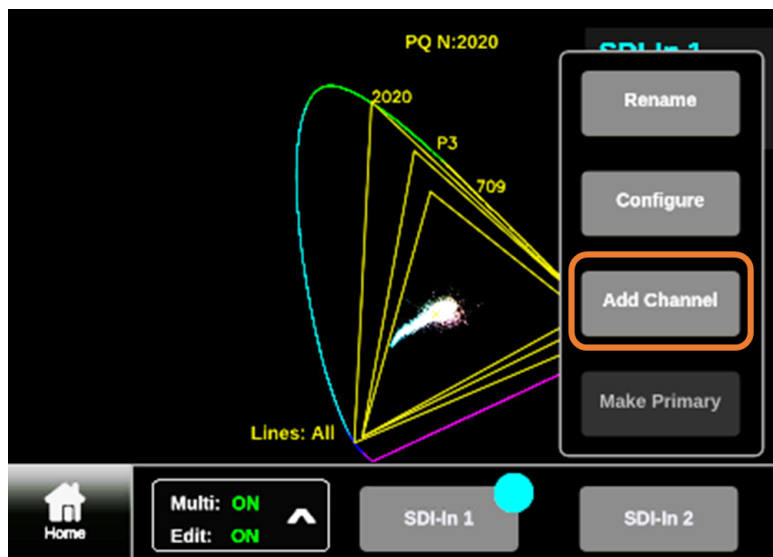

The input appears in the list of channels with a white dot.

Note: If there are already four inputs selected, an error message appears. Follow the instructions in the message to remove a channel.

C. Repeat steps *a* and *b* until all the needed channels are selected.

Change Primary Channel

One of the inputs must be the primary channel. When you selected the multiple SDI inputs the primary channel was chosen for you.

To reassign the primary channel:

1. Select one of the secondary channels marked with a white dot (the potential primary channel must be selected as a monitored channel).
The input menu opens.
2. Select **Make Primary** from the menu.

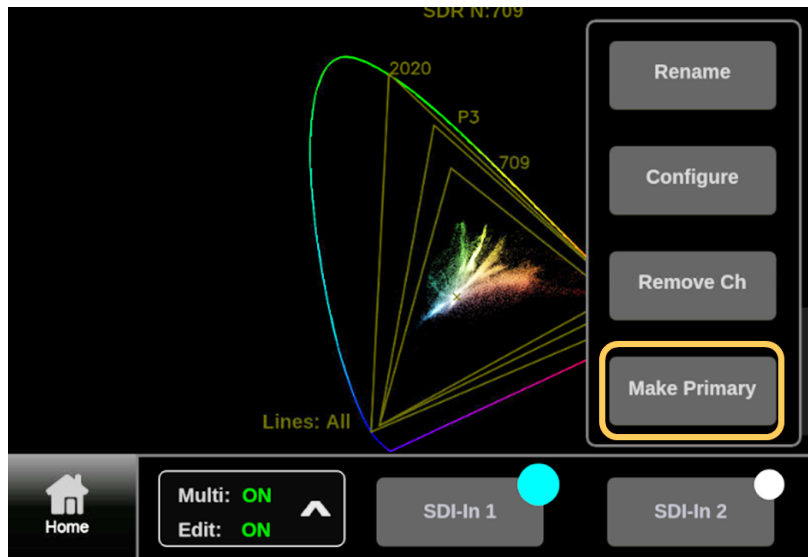

The selected secondary input becomes primary and the primary becomes a secondary; the white dot turns cyan and the cyan dot turns white. In the multi-input menu, the titles in the tiles change color and any tiles set to Follow Primary change to the selected input.

Follow Primary means a tile input configuration follows the primary input, no matter what input is selected as the primary. If a secondary input is changed to primary, all tiles set to Follow Primary change to the new primary input.

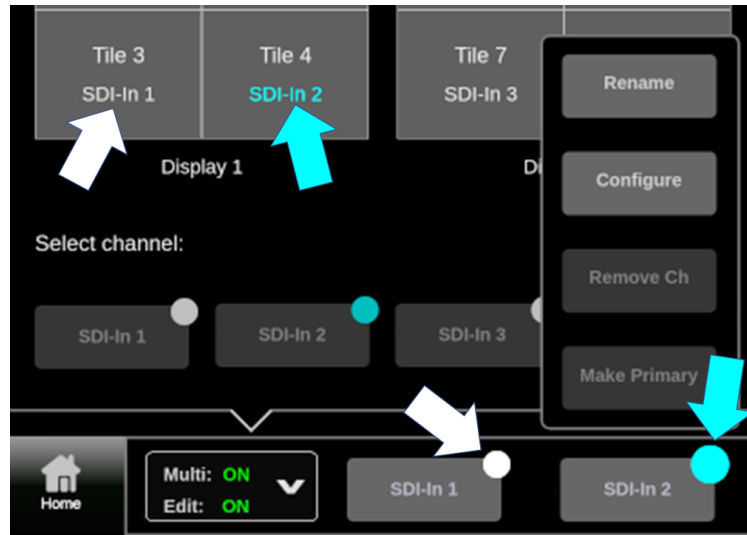

Note: Because the primary input becomes a secondary input, if a tile that is now using a secondary input has a primary-only application, the tile displays a message that the application cannot work with a secondary channel.

Set Input Tiles

To set the Multi Input tiles to display specific inputs:

1. In the tile map, select a Tile 1-4, or 1-8 if there is an extended display (8 tiles also requires the option MP2-EXTNDSP). Select as many tiles as needed to monitor a single input.

2. Select the input to display from the list of selected inputs at the bottom of the Multi menu or select Follow Primary.

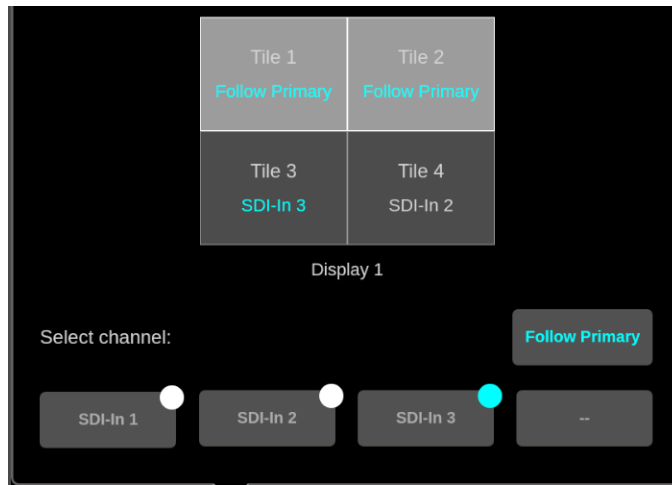

The labels in the tiles show the name of the selected input (such as SDI-In 1), it also shows if they are following the primary (the tile label shows “Follow Primary”). If the selected input is the primary channel, the tile information is in cyan.

Reset Tile Map

To reset the Multi Input tile map back to default:

1. In the Multi menu, select **Reset**.

Reset sets all the tiles in the tile map to Follow Primary, it sets channel 1 (the input at the far left of the input menu) as the primary, and it removes all selected inputs from the channels list (no other inputs are selected for monitoring). It leaves the previously selected applications in the tiles but they are all set to monitor the primary input.

2. Select the multi-input menu button to close the menu.

Adjust Source Label

The input information (label) in the tile contains the name of the input it is set to monitor (like SDI-In 2), if the tile is following the primary, the signal format, and the frame rate of the input.

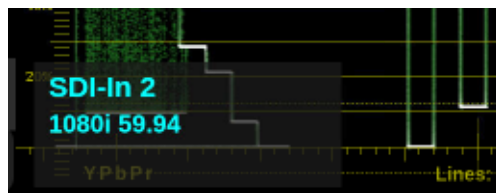

Open the Source Label controls: Select the **Settings** icon (⚙️), and then select **Display**.

- To move the Source Labels: Open the Source Label Position menu and select the location for the label from the options. You can also select-and-drag the label to one of four locations (bottom left or right, top left or right).
- To set the Source Label timeout: Open the Source Label Timeout menu, and select when and how the label should appear.
- To show hidden labels or brighten dimmed, select the **Home** icon ()

If the primary input is missing, or if any secondary input frame rates are incompatible with the primary input (for example an input of 1080i/59 is incompatible with an input of 1080i/50), the trace applications will function but might have reduced trace quality.

Multi-Input Applications

In using applications with multiple inputs, there are some limitations. Because multiple inputs only work with SDI inputs, the IP input applications are not applicable. Several applications only work with the chosen primary channel.

Primary-only applications:

- Video Session
- Audio
- Dolby Status
- AES Channel Status
- ANC Session
- Datalist
- Timing
- AV Delay

Some applications only work with IP inputs and so are not relevant to Multi Input mode:

IP input applications:

- IP Graphs (partial)
- Stream Timing
- PIT Histogram

Note: These primary-only applications are marked with a cyan dot when the Multi Input mode is on. The applications are marked in the Application bar and the All Application menu.

IP applications that are not tied to IP Inputs are functional in Multi Input mode:

- IP Status
- IP Session (Layer 1/2 and PTP tabs)
- PTP Graphs

Note: These Picture application functions are only available to the primary channel: Convert to Rec. 709, Source ID Overlay, Closed Caption, HDR Measurements, and Lightmeter.

Set for 2110 Fast Switching

This procedure sets up the instrument for 2110 fast switching between inputs. This mode enables a make-before-break setting for 2110 signals. The system subscribes to the second video stream, switches at the marker bit, and then unsubscribes from the first stream.

Twice the bandwidth is required to handle two IP streams during input transitions. If there is insufficient bandwidth for the make-before-break operation, the system will drop packets during the transition. In this situation you might want to disable this feature. This condition will likely occur for 4K/50p signals on a 10G network or if there are other signals on the link that would reduce the bandwidth to be insufficient for make-before-break operation.

Fast Switching Benefits:

- Switching 2110 inputs is much faster.
- Switching between inputs displays complete frames on the picture application.
- It reduces switching errors in the Event Log and IP Graphs.
- SDI Aux out switches between the two sources with no CRC errors.
- SDI Aux out seamlessly switches between the two sources.

Prerequisites for 2110 Fast Switching:

- Signals to fast switch must be the same exact resolution, frame rate, and structure or fast switching is not possible.
- Set the virtual inputs being fast switched to the Resolution, Frame Rate, and Structure of the signals, or for NMOS applications the format specified in the SDP file.

Note: If the Resolution and Frame Rate of the input does not match the actual signal, the Picture could produce false images to the point of being unusable.

- 2110-20 video inputs must be locked to PTP and well timed.
 - PRISM will tolerate a maximum skew between the streams up to 500 microseconds with the skew taking into account jitter and delay.
 - The aux out jitter specification must be met for each stream if the AUX OUTPUT Loop-through is enabled.

- For best switching time performance:
 - Streams should have the same Packing Mode: Block or General.
 - Streams should have the same Packet Read Schedule (PRS): Gapped or Linear.
 - Streams should be 2110-21 compliant.

When a PRISM receives a new stream that does not meet the prerequisites, fast switching might not be possible.

Set 2110 Fast Switching through NMOS

Activate the video receiver with an SDP file containing the appropriate format information. The format information for video is defined in the *a=fmtp* line.

Required Media Type Parameters

Include the payload-format-specific Media Type parameters in the *a=fmtp* clause of the SDP for all streams conforming to this standard. This sample is a part of an SDP file.

```
v=0
o=- 123456 2 IN IP4 0.0.0.0
s=Sample video SDP file (ST 2110-20 with ST 2022-7)
i=1080p@50 Hz video streams
t=0 0
a=group:DUP first second
a=recvonlym=video 20000 RTP/AVP 96
i=First video stream description
c=IN IP4 239.20.10.113/8
a=rtpmap:96 raw/90000
a=mid:first
a=fmtp:96 sampling=YCbCr-4:2:2; width=3840;
height=2160; exactframerate=60000/1001; depth=10; TCS=SDR; colorime-
try=BT2020; PM=2110GPM; TP=2110TPN; SSN=ST2110-20:2017;
a=ts-refclk:localmac=98-03-9B-A0-88-83
a=mediack:direct=0
m=video 20000 RTP/AVP 96
i=Second video stream description
c=IN IP4 239.20.20.113/8
a=rtpmap:96 raw/90000
a=mid:second
a=fmtp:96 sampling=YCbCr-4:2:2; width=3840;
height=2160; exactframerate=60000/1001; depth=10; TCS=SDR; colorime-
try=BT2020; PM=2110GPM; TP=2110TPN; SSN=ST2110-20:2017;
a=ts-refclk:localmac=98-03-9B-A0-88-82
```

`a=mediack:direct=0`

sampling: Signals the color difference signal sub-sampling structure. Possible values are YCbCr-4:2:2 and RGB-4:4:4.

depth: Signals the number of bits per sample. Possible values are 10 or 12.

width: the number of pixels per row. Permitted values are integers between 1 and 32767 inclusive. PRISM supports 720, 1280, 1920, and 3840.

height: the number of full-bandwidth sample rows per frame. Permitted values are integers between 1 and 32767 inclusive. PRISM supports 486, 576, 720, 1080, and 2160.

exactframerate: the frame rate in frames per second. Integer frame rates are written as a single decimal number (for example 25). Non-integer frame rates are written as a ratio of two integer decimal numbers separated by a forward-slash (for example 30000/1001) using the numerically smallest numerator value possible. PRISM supports 24000/1001, 24, 25, 30000/1001, 30, 50, 60000/1001 and 60.

colorimetry: the system colorimetry used by the image samples. Supported values are BT709, BT2020, and UNSPECIFIED. UNSPECIFIED means the PRISM uses whatever value was manually set (see the Color Gamut menu).

Media Type Parameters with Default Values

Senders can include the format-specific Media Type parameters in the `a=fmtp` clause of the SDP for all streams using this standard.

interlace: If this parameter name is present, it means the video is interlaced, or the video is Progressive segmented Frame (PsF). If this parameter name is not present, the progressive video format is used.

segmented: If this parameter name is present, and the interlace parameter name is also present, then the video is a Progressive segmented Frame (PsF). Using this parameter without the interlace parameter is not possible.

TCS: Transfer Characteristic System—this parameter specifies the transfer characteristic system of the image samples (in the Gamma Curve menu in the settings for an input). Supported values are SDR, PQ, HLG, and UNSPECIFIED. If the TCS value is unspecified, receivers use the value SDR. UNSPECIFIED means the PRISM uses whatever value was manually set (see the Gamma Curve menu).

These attributes determine the PRISM settings. These all correspond to one of the format menus:

- The TCS attribute sets the Gamma Curve.

Note: For SDR and HLG, these are always narrow for 2110.

- The colorimetry attribute sets the Color Gamut.
- The width and height attributes set the Resolution.
- The exactframerate attribute—and the presence or absence of the interlace and segmented attributes—set the Frame Rate.

Set 2110 Fast Switching through UI

1. Select the **Settings** icon () and then select **Inputs**.
2. Set the 2110 Fast Switching to **On**.



3. Set up the first IP input. See [Set ST 2110 Configuration](#) for how to set up an IP 2110 input.
4. In the Input set Format Detection to **Manual**.

Note: Setting Format Detection to Auto is not effective for fast switch; the setting must be made manually.

5. Set the Resolution, Frame Rate, and Structure (if the option is available) to the same settings as the signal.

See [Prerequisites for 2110 Fast Switching](#): for requirements of setting up inputs for fast switching.

Note: If the Resolution and Frame Rate (and any Structure) of the input does not match the actual signal, the Picture could produce false images to the point of being unusable.

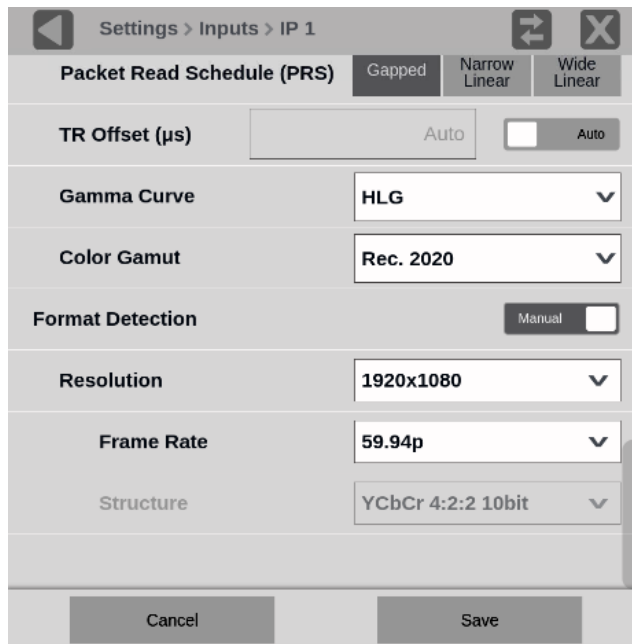

- A. Find the resolution and frame rate of the incoming signal; set the Format Detection to **Auto** and select **Save**.
- B. Open the **Video Session** application.

The resolution, frame rate, and structure are listed near the top of the tile.

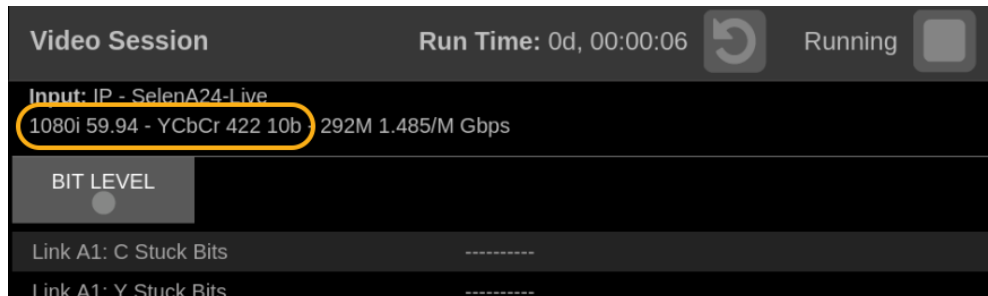

- C. In the Inputs menu, set the Format Detection to **Manual**.
- D. Set the Resolution and Frame Rate, and Structure if needed, to the measurements from the Video Session application and select **Save**.

When the selected virtual input has been manually set, the details in the Status Bar are yellow.

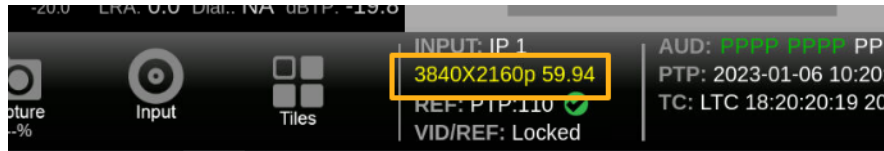

- 6. Set up the second input the same as the first.
- 7. Switch between the configured IP inputs.

Note: If you are switching to a 3rd input, you may need to allow for the first stream to leave or link saturation may occur.

Configure Instrument for HDR/WCG Monitoring

PRISM provides HDR/WCG monitoring features that aids in the set up and balance of cameras in HDR/WCG during content creation. Before using these features, configure the virtual input (see [Configure and Select Virtual Inputs](#)). Use the Gamma and Color Gamut menus to adjust the PRISM monitor settings to reflect the input signal properties if they are not automatically selected.

These applications and features are used to configure the instrument for HDR/WCG monitoring.

Waveform

For details on setting a graticule in Waveform, see Waveform: [Graticule](#).

Stop Display

For details on setting a stop or Nits graticule in Stop Display, see Stop Display: [Reference](#).

Transfer Function/Color Space Conversion

The Transfer function/color space conversion is available in Waveform, Vector, Diamond, and Picture applications. Select the Convert to Rec. 709 feature to convert the Gamma / Gamut settings for the signal to the BT. 709 Gamma / Gamut signal. This feature allows you to match the skin tone and the color in BT. 709 Gamma / Gamut displays. The conversion between input video and linear light is processed in Scene light.

Note: Convert to Rec. 709 mode is not supported for SD signals.

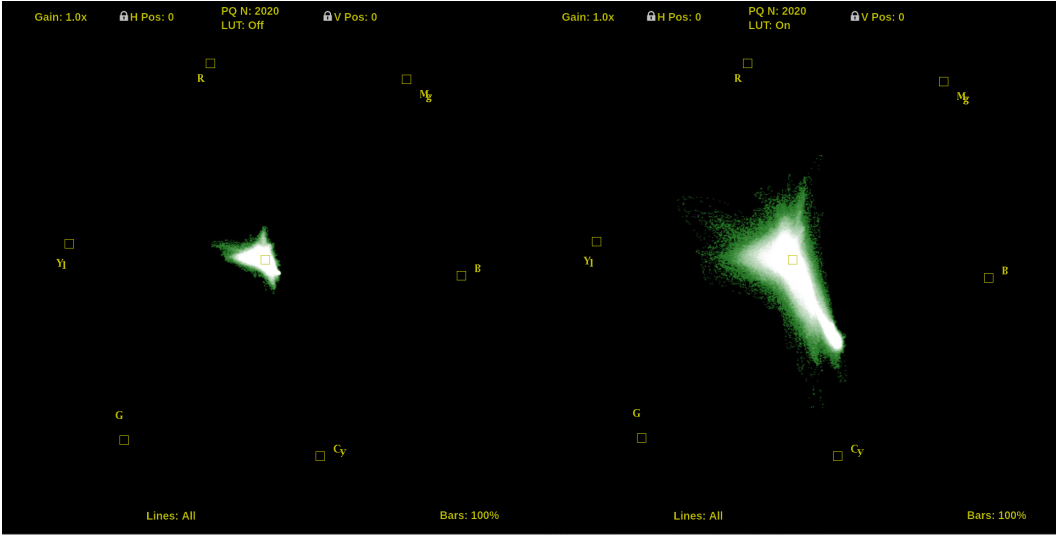

Enable NMOS

The NMOS/SDP and API allows system integrators to build an IP system with PRISM being managed by system management software. The software discovers, registers, configures inputs, and selects the active input for monitoring. The NMOS implementation is compatible with IS-04 discovery and registration, and IS-05 device connection management.

Enable NMOS Discovery and Registration

To enable NMOS on your instrument:

1. Select the **Settings** icon () to open the Settings menu.
2. Select **Network** to open the Network submenu.
3. Select **NMOS** in the Network menu.
4. Set the Enable NMOS Discovery & Registration control to **Enabled**.
5. Set the NMOS Discovery Version to Version 1.2 or Version 1.3, according to the system management software. See [NMOS Specifications](#) for details of version 1.3.
6. Set NMOS DNS to Auto, Multicast, or Unicast as needed.



Note: The PRISM checks for DNS registry announcements to find an NMOS registry. In case of multiple registries, the PRISM attempts to register with the NMOS registry with the highest priority (0 is highest). If NMOS DNS is set to *Auto*, all Multicast and Unicast registry announcements are considered. Selecting *Multicast* or *Unicast* only shows that type of registry announcement.

Note: The Advertised Port is the physical port on the back of the instrument. The Control selection is for the RJ-45 10/100/1000Mbps Ethernet port.



Note: When changes are made to the control port IP address or the label of the instrument and NMOS is being used for configuration, we recommend rebooting the instrument to update the NMOS registration server.

Enable Persistent NMOS

Persistent NMOS allows the PRISM NMOS receivers to stay enabled if the current input is NMOS enabled or not. In the standard NMOS mode (without persistent NMOS), when a user disables an NMOS input (select any input that is not the NMOS-enabled input), the existing NMOS receivers are disabled and are removed from the registry.

With persistent NMOS, the user selects a Target Input (one of the six inputs) for all NMOS activations to configure (this selection automatically sets the selected input to IP, ST2110, and enables NMOS). All NMOS activations then continuously configure the selected Target Input, whether the input is disabled or not.

To enable persistent NMOS on the instrument:

1. Select the **Settings** icon () to open the Settings menu.
2. Select **Network** and then select the **NMOS** tab.
3. Set the Enable NMOS Discovery & Registration control to **Enabled**.
4. Set the Persistent Receivers to **Enabled**.
5. Set the Target Input number to the input to receive persistent NMOS updates.
The selected input is automatically set to IP, ST2110, and NMOS is enabled (the name of the input is also set to "NMOS") no matter the previous settings. But the change to the input only happens after an NMOS controller or API call activates the receiver.
6. Select the **Input** icon () from the Status bar at the bottom of the PRISM monitor.
7. Switch between the NMOS-enabled input and any other inputs.
The NMOS updates will continue to the NMOS-enabled input even when the input is not active (selected).

Note: When persistent NMOS for the input is disabled (either the Persistent Receivers is set to Disabled or the Target Input is changed to a different input), the original NMOS-enabled input is still NMOS, but the NMOS activations no longer update the input configuration.

Reset NMOS

To clear the NMOS configurations on the instrument: Select **Reset** and then select **Ok**.
A loading icon appears as the configuration is loaded.

Note: Using RESET deletes the internal NMOS presets folder, removes any previous history of connections, and sets the NMOS configuration back to default values.

Adjust Audio Settings

The Audio settings menu has several tools that relate to aspects of the Audio application, the audio signal, and aural output. Details of several of these can be found in other parts of the document where they are specifically relevant.

1. Select the **Settings** icon () to open the Settings menu.
2. Select **Audio** to open the Audio submenu.

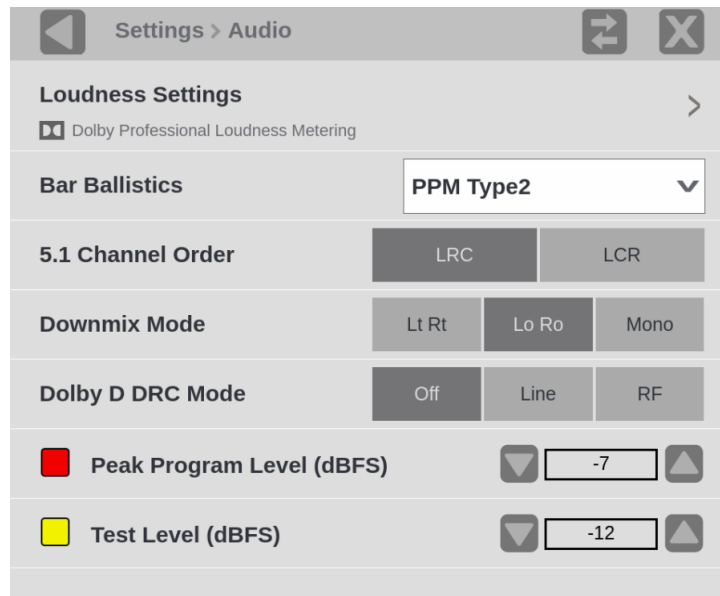

Loudness Settings

For details about Loudness Settings, see [Loudness Display](#).

Bar Ballistics

For details about ballistics options, see [Ballistics](#).

5.1 Channel Order

For details about channel order options for 5.1 programs, see [5.1 Channel Order](#).

Set Downmix Mode

For details about Downmix Mode options, see [Downmix Controls](#).

Configure Dolby D DRC Mode

Select Off, Line, or RF.

Line and RF are modes of Dynamic Range Control (DRC)—compression—factors that are applied when decoding Dolby content for monitoring or output.

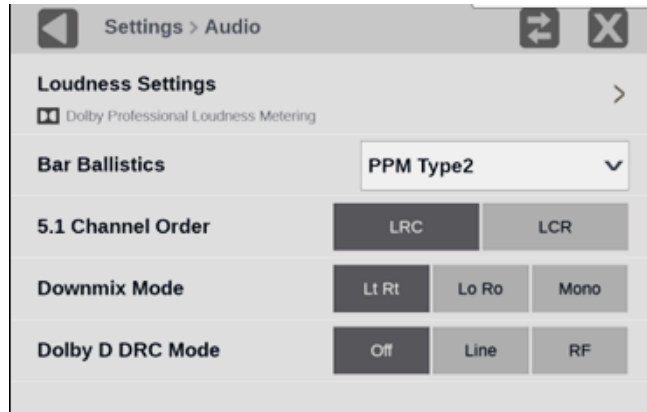

Select Downmix Dynamic Rng. Select Line or RF. These DRC compression factors are applied when downmixing to the various Dolby D listening modes.

Peak Program Level (dBFS)

This level is marked by the red arrow in the Audio application. Audio above this mark is shown in red. This audio is above the peak level.

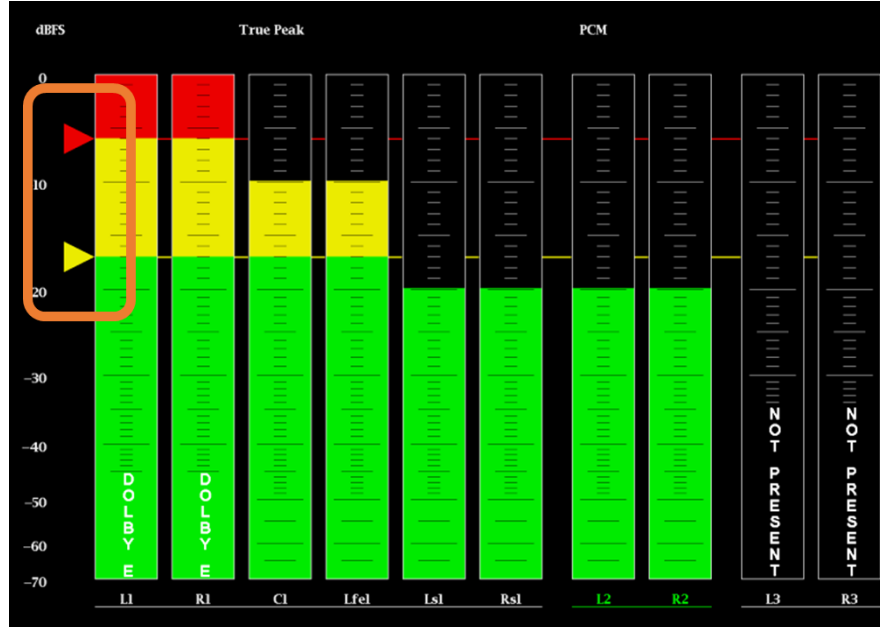

To change the Peak Program Level (dBFS) number:

1. In the Audio settings menu, select in the Peak Program Level (dBFS) field.

2. Enter the number on the keypad or select the up or down arrows.

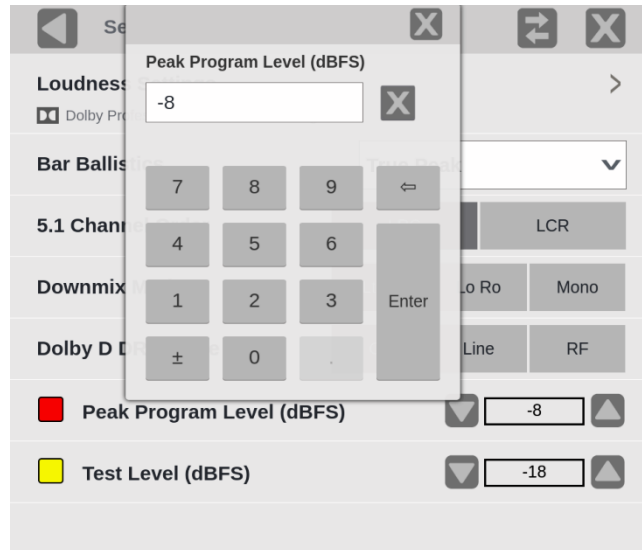

Test Level (dBFS)

Also called the reference or line-up level, the Test level is the yellow arrow in the Audio application. Audio above this mark is shown in yellow. This audio is between the test and peak levels.

To change the Test Level (dBFS) number:

1. In the Audio settings menu, select in the Test Level (dBFS) field.
2. Enter the number on the keypad or select the up or down arrows.

Note: The Test Level cannot be set above the Peak Program Level. If the peak is set to -5 then the test cannot be -4. If the test is set to -4 (through either the arrows or the keypad), the peak is automatically set to -4, also.

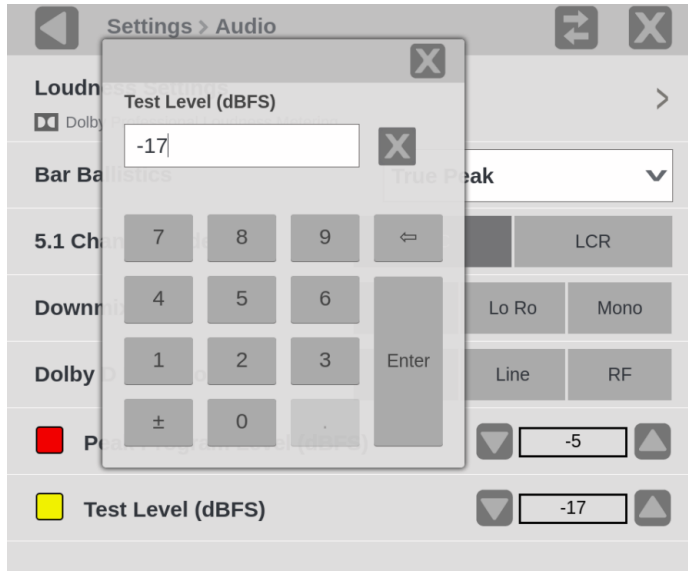

Configure Instrument Outputs

PRISM allows you to set the AUX OUT connector to Loop-through or Generator, and turn on the SDI loop-through. The AUX OUT connector always contains an SDI signal.

AUX OUTPUT 1/2

1. Select the **Settings** icon () and select **Outputs**.
2. Set the AUX OUTPUT 1/2 to Loop-through or Generator.

Loop-through option sends the active SDI or IP signal to the AUX OUT connector. If the active signal is IP, it is converted to an SDI signal at the AUX OUT connector.

Note: AUX OUT loop-through of IP inputs is available for SDI, ST 2022-6, and 2110-20/30/31 (see [Configure Audio \(2110-30 / 31\) Stream](#) for audio configuration details) including embedded audio streams.

Generator option sends the output of the SDI generator to the AUX OUT connector. See [SDI Generator Application](#) for instructions on how to configure the SDI Generator signal.

AUX OUT AUDIO CHANNELS

For 2110 Inputs, the aux out can be configured to remap the audio pair selected by the Headphone Pair to Aux Out pairs 1/2, regardless of their location in the Audio application.

1. Select the **Settings** icon () and select **Outputs**.
2. Set the AUX OUTPUT AUDIO CHANNELS to **Selected headphone pair on Ch-1 and Ch-2**.
3. In the Status bar, select **Volume**.
4. Select the pair from the list. All other audio pairs on the Aux Out are muted.

Note: In the case of multi-channel audio, the Aux Out audio does not support remapping of down-mixed audio, pair 1/2 is output instead.

Note: If the audio is decoded Dolby content, the volume pair selection is the raw pairs, with the exception that undecoded Dolby is not sent to the aux out to prevent speaker damage.

5. Set the SDI LOOP-THROUGH control to **On**, to loop-through SDI signals regardless of what signal is active. SDI 1 loops out to SDI 3 and SDI 2 loops out to SDI 4.

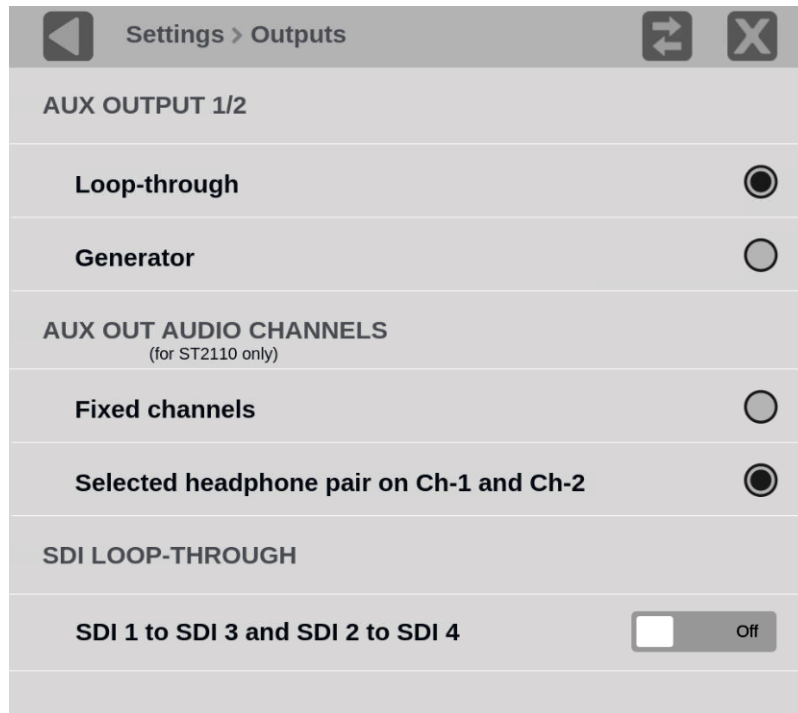

6. Close the Outputs menu.

Configure to Decode Timecode

Timecode decodes and displays ST 12-1:2014 Ancillary Timecode on the Status bar. ANC LTC (linear time code), ANC VITC (vertical interval time code), and Date Readout are supported.

1. Select the **Settings** icon () to open the Settings menu.
2. Select **Anc Data** to open the Anc Data submenu.

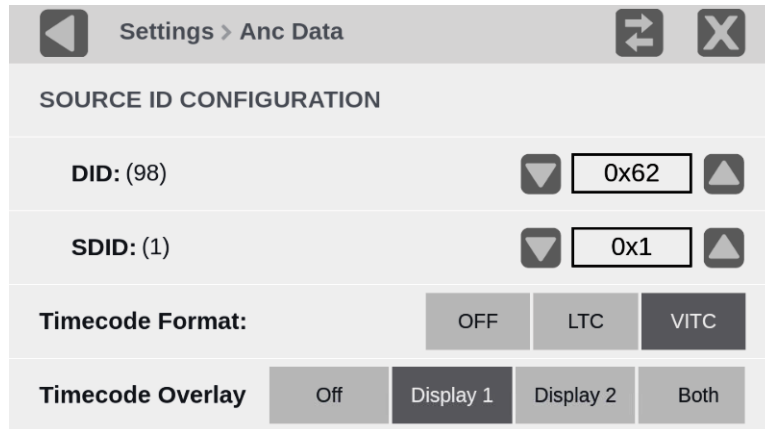

Select Timecode Format

In Timecode Format select LTC or VITC as needed.

Note: Changing the timecode format changes the timecode at the bottom of the Status frame, all alarms and events, and in the timecode overlay.

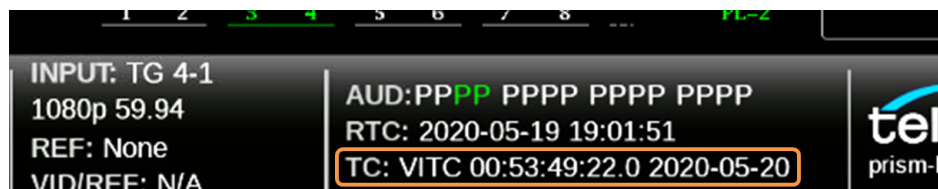

Turn on Timecode Overlay

In Timecode Overlay, select Off, Display 1, Display 2, or Both.

Note: Both Timecode Overlays match the Timecode Format (LTC or VITC) in the Anc Data menu and the timecode in the Status frame.

Off: No timecode overlay is displayed.

Display 1: Adds a timecode overlay to *only* the first monitor or screen.

Move the timecode: select it and drag it to any place in the first monitor or screen.

Display 2: Adds a timecode overlay to *only* the second monitor or screen.

Move the timecode: select it and drag it to any place in the second monitor or screen.

Both: Adds a timecode overlay to both monitors or screens (one on each).

Move each timecode independently: select one and drag it to any place in the respective monitor or screen.



Configure Reference Settings

The reference configuration of the PRISM is displayed in the middle of the status bar. The third line is the reference type and the fourth line displays the Video versus Reference lock indication. This indication shows if the signal is N/A, Mismatched, Drifting, or Locked.

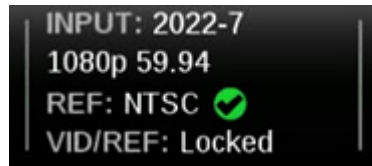

The Timing application supports SDI timing against Analog external reference, Analog external reference timing against PTP, SDI timing against PTP, and IP timing against PTP.

Choose External Reference

1. Select the **Settings** icon () to open the Settings menu.
2. Select **Reference** to open the Reference submenu.



3. Select one of the reference options:

Internal: The timing is based on an internal clock.

Analog: Refers to a Black Burst or Tri-Level Sync (TLS) external reference. An analog external reference is connected to the REF BNC input on the back panel.

PTP: Refers to Precision Timing Protocol (PTP) external reference. PTP external reference must come through the 10/25GE SFP Port 1 input on the back panel.

Note: When a reference selection is made the reference changes in the status bar and in the Timing application.

Configure Analog Reference Settings

1. Select the **Settings** icon () to open the Settings menu.

2. Select **Reference** to open the Reference submenu and select the **Analog Ref Setting** submenu.

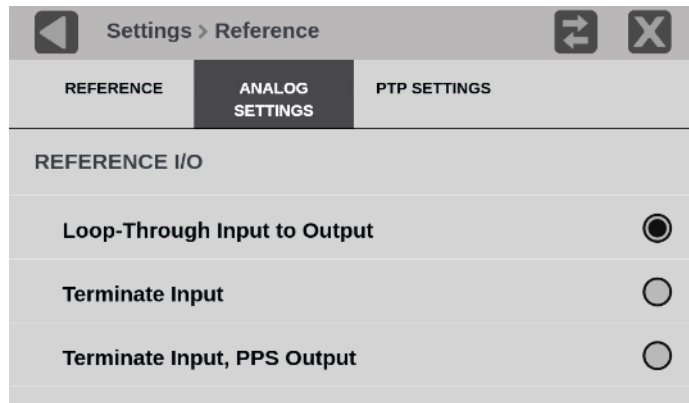

3. Select one of the reference I/O options:

Loop-Through Input to Output: The REF input is looped out the REF output BNC.

Terminate Input: The REF input is terminated at the REF input BNC. There is no signal at REF output BNC.

Terminate Input, PPS Output: The REF input is terminated at the BNC. The REF output BNC will have the PPS signal when the PTP is locked.

Configure PTP Reference Settings

1. Select the **Settings** icon (⚙️) to open the Settings menu.
2. Select **Reference** to open the Reference submenu and select the **PTP Settings** submenu.

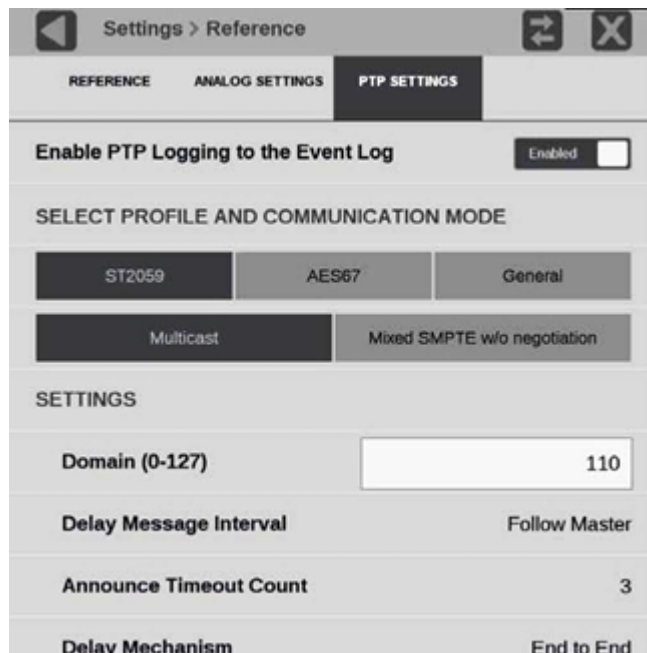

3. To enable or disable PTP logging to the Event Log, select the control box to change the setting to the state.
4. Select the profile to configure: ST2059, AES67, or General. The default communication mode for each profile is Multicast.
5. If you select the ST2059 profile and the communication mode, it is a mixture of Multicast and Unicast, select **Mixed SMPTE w/o negotiation**.

Note: On the SMPTE profile mixed mode, the PTP Announce and Sync messages are sent as Multicast. However, the Delay request and Delay Response messages are sent as Unicast.

6. Select the **Domain (0-127)** box to open the editing display.

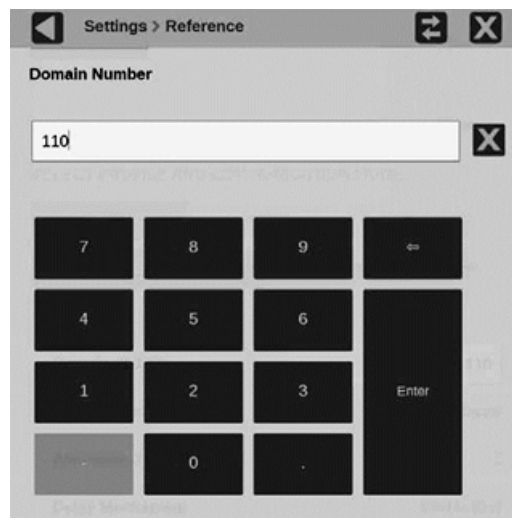

7. Use the editing controls to enter a new domain number. When using the editor:
 - Select the Clear icon (X) to remove the existing domain number.
 - Select the **backspace** key to delete characters by backspacing over them.
8. When you are done editing the domain number, select **Enter**.
9. Repeat steps 4 to 8 for each PTP profile.

Set and Recall Instrument Presets

Instrument setups can become complex as you tailor them to monitor various parameters. To save set up time and ensure consistency, you can save and quickly access instrument setups in your instrument using the Presets icon () on the instrument display.

Note: For the MPX2-25 monitor, you can recall instrument presets from the front panel. (See [Recall Instrument Presets](#).)

The instrument can store up to 36 separate instrument presets. The presets are divided into six groups, A through F, with each group containing 6 preset storage locations. The default preset names are A1-A6, B1-B6, C1-C6, D1-D6, E1-E6, and F1-F6.

All instrument settings except those set in the Utilities and Network Settings submenus of the Configuration menu are saved in a Preset. Settings that are not saved are those such as the clock setting, IP configuration, and network address. This is an overview of the settings saved in a Preset. Some settings are option dependent:

- Application assigned to each tile
- Application icon order in the application selector list
- Application specific settings
- Input selection and configuration (including single- and multi-input mode)
- PTP reference settings
- SDI Generator and IP Generator settings

Turn on Edit Mode

When Edit mode is on, selecting a preset button displays a menu to allow changes to that preset button (Rename and Save as) you can also recall the existing settings (Recall). You can assign any preset button with any configuration of applications, outputs, and inputs.

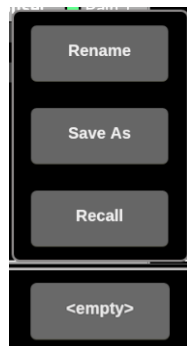

When edit mode is off, selecting a preset button only recalls the preset settings assigned to that button, with no confirmation.

To set Edit Mode on:

1. Select the **Settings** icon (⚙️) to open the Settings menu.
2. Select **Presets** to open the Presets submenu.
3. Set Edit Mode to **On**.

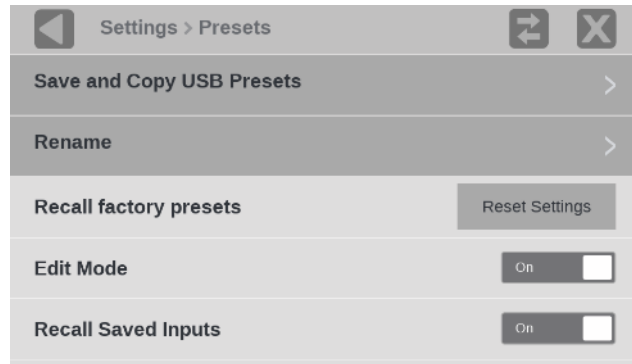

Save Presets

To save a preset with a user-defined name and settings, or to reassign a named preset with new name and settings:

1. Set up the instrument exactly as you want it configured. This includes selecting the application display for each tile and configuring inputs and the PTP reference settings.
2. *Turn on Edit Mode.*
3. Select the **Presets** icon (★) to open the Preset selection menu at the bottom of the PRISM display.

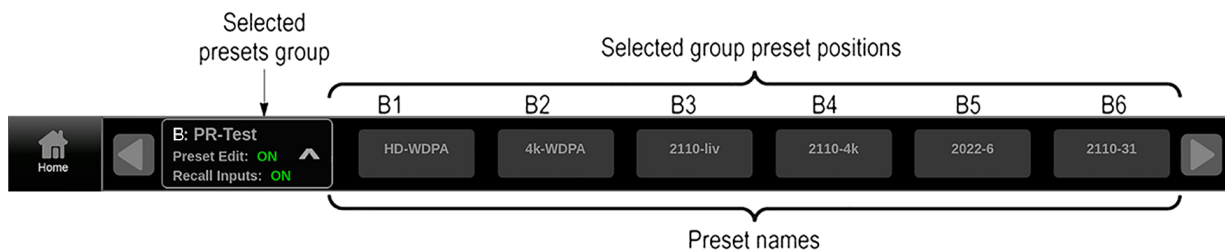

4. Locate the Preset button you want to save with the current instrument configuration. There are 6 presets in each of 6 groups. Use the arrow buttons (◀ and ▶) or swipe left or right to move to the preset group (A–F).

Note: When a preset has no content, <empty> is displayed on the preset button.

5. When you have found the preset to assign the settings (this includes choosing an assigned preset and overwriting the existing settings), select the preset button.

A menu displays.

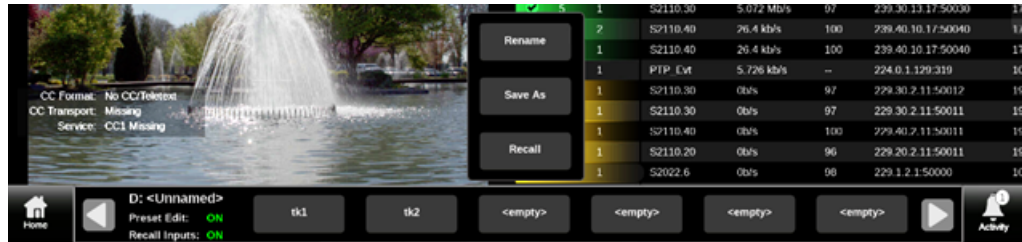

6. Select **Save As** to save the existing settings to the highlighted preset button and name it.

An on-screen keyboard appears.

7. If the preset button name is <empty> or you want to change the name, use the keyboard. If you do not want to change the name, select **Save**.

A confirmation window displays.

8. Select **OK** to save the preset.

The preset name changes from <empty> or a name to the entered name. The number is the preset position in the preset group.

9. Select the **Home** icon () to close the Preset selection menu.

Rename PRISM Presets

To rename a preset without changing any settings.

1. *Turn on Edit Mode.*
2. Select the preset to rename.
3. Select **Rename** and use the keyboard to enter a new name.
If Rename does not appear, Edit mode is not on.
4. Select **Save**.

Rename Group of Presets

1. Select the **Settings** icon () to open the Settings menu.
2. Select **Presets** to open the Presets submenu.

3. Select **Rename** to open the Presets Rename submenu.

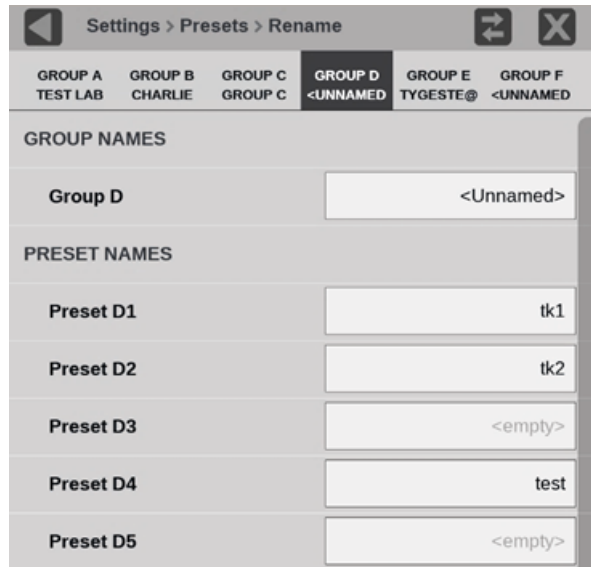

4. Select the Preset group, at the top of the submenu, to select the group with the preset to rename (this includes naming an <empty> preset).

5. Select the name box of the preset you want to name or rename.
An on-screen keyboard displays.

Note: You can also rename a preset group by selecting a group name box.

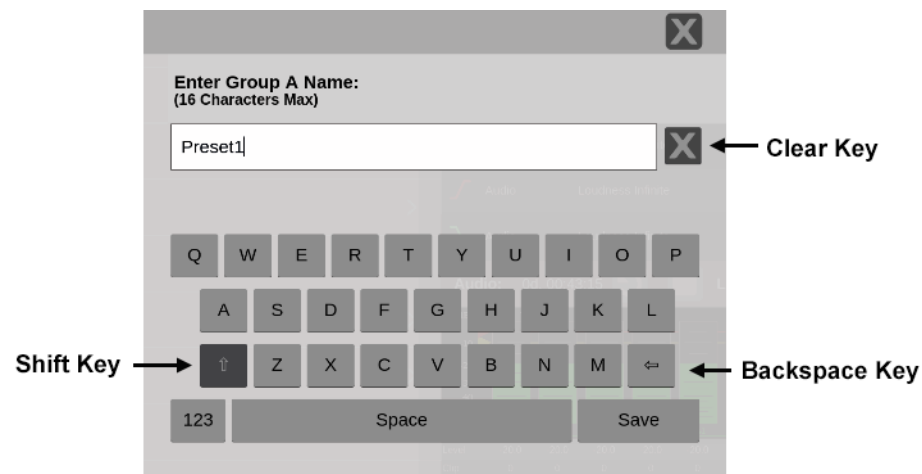

6. Use the on-screen keyboard to enter a new name for the preset. When renaming a preset:
 - Enter a name with a maximum of 16 characters.
 - Select the Clear icon (✕) to remove the existing name.
 - Select the Shift key to access capital letters.
 - Select the Backspace key to delete characters by backspacing over them.
 - Select the 123-abc key to change between the letter keyboard and the numbers-symbols keyboard.
7. When the preset name is correct, select **Enter**.

Note: If the Edit Mode is on, you can rename a preset through the Preset selections menu. Select the preset to rename and then select **Rename**, and rename the preset just as in the Presets Rename submenu.

Download and Upload PRISM Presets

To download the presets of an entire PRISM (clone the presets) and upload them to another PRISM, there are two methods: [Download Presets to USB Drive](#) or [Download File of Presets Locally](#).

Download Presets to USB Drive

1. Insert a USB drive into the PRISM with the presets.
2. Select the **Settings** icon (⚙️) to open the Settings menu.
3. Select **Presets** to open the Presets submenu.
4. Select **Save and Copy USB Presets** and then select **SAVE TO USB**.
5. Select the USB drive and select **Save**.

A copy of the presets is downloaded to the USB drive.

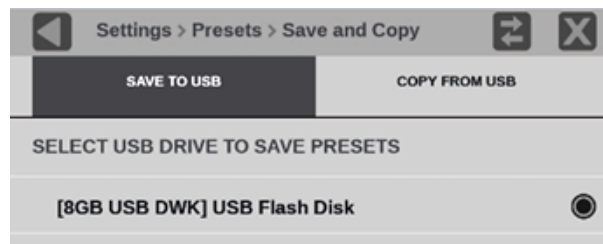

6. Select the Activity icon (🔔) and then select the **Eject** icon (🗑️) to unmount the USB drive from the instrument.
7. Remove the USB drive with the presets from the PRISM.
8. To upload the presets to another PRISM, go to [Upload Presets from USB Drive](#).

Upload Presets from USB Drive



CAUTION: Uploading presets overwrites all existing presets in the PRISM.

1. Insert a USB drive with PRISM presets into the PRISM to upload the presets.
2. Select the **Settings** icon (⚙️) to open the Settings menu.
3. Select **Presets** to open the Presets submenu.
4. Select **Save and Copy USB Presets** and then select **COPY FROM USB**.
5. Select the USB memory drive and select **Copy**.

The downloaded presets are uploaded to the PRISM.

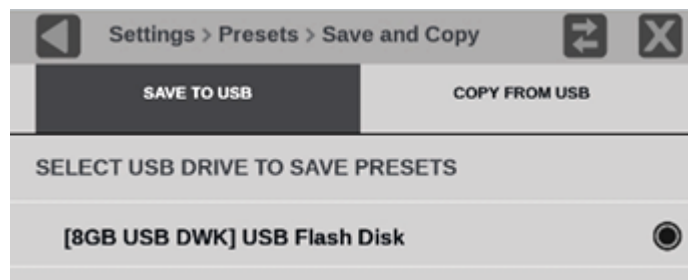

6. Select the Activity icon (🔔) and then select the **Eject** icon (🗑️) to unmount the USB drive from the instrument.
7. Remove the USB drive with the presets from the PRISM.
8. Select the Close icon (✕) to close the Save and Copy USB Presets submenu.
9. Repeat steps 1 to 9 for any other PRISMs to copy the presets.

Download File of Presets Locally

1. Use a web browser to access the PRISM HOME page for the PRISM with the presets.

2. Select **Preset Download and Upload**. (Some home pages have different options than the example.)

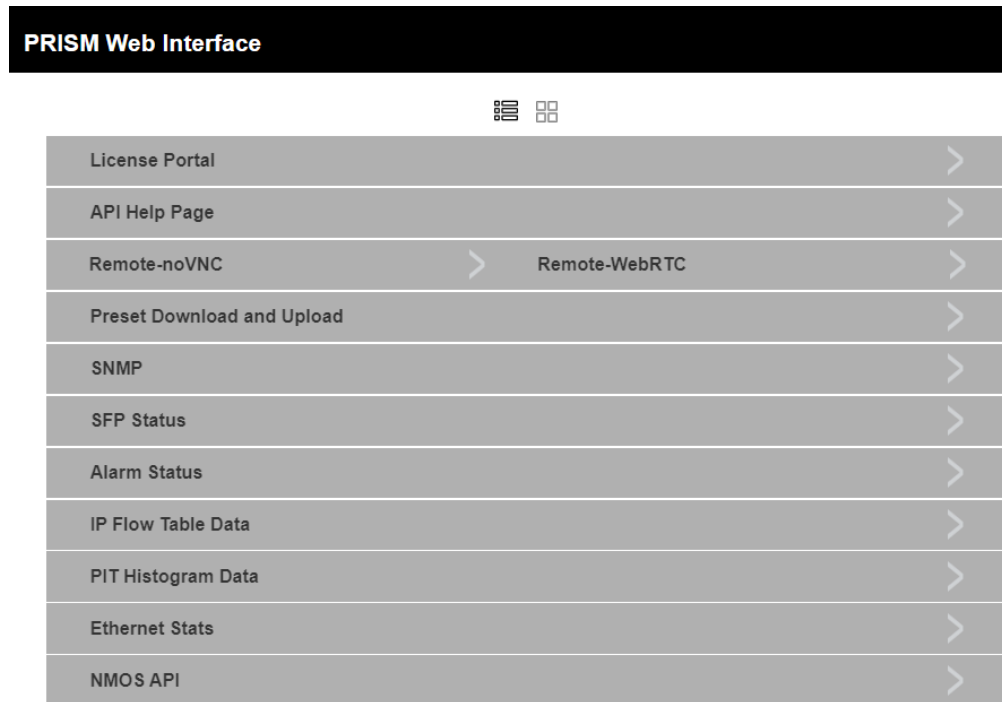

3. Select **Download from PRISM** and then select **Download**.

A copy of the presets is downloaded to the local computer with the name of the PRISM and a timestamp, or you can rename the presets file.

4. To upload the presets to another PRISM, go to [Upload Presets through PRISM Homepage](#).

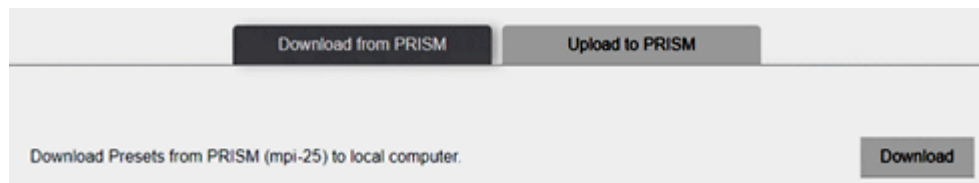

Upload Presets through PRISM Homepage



CAUTION: Uploading presets overwrites all existing presets in the PRISM uploading the presets.

1. With the presets file downloaded locally, go to the PRISM HOME page for the PRISM to upload the presets.
2. Select **Preset Download and Upload**.

3. Select Upload to PRISM and then select Browse.

A file explorer window displays.



4. Find the saved preset (.prst) file, select it, and select Open.

The file explorer window closes and the preset file is listed on the PRISM HOME page.

5. Select Upload.

The downloaded presets are uploaded to the PRISM.

6. Repeat steps 1 through 5 for any other PRISMs to receive the same presets.

7. Select the browser back button to return to the PRISM HOME page.

Recall User-Defined Presets

1. Select the Presets icon (★) to open the Preset selection menu.

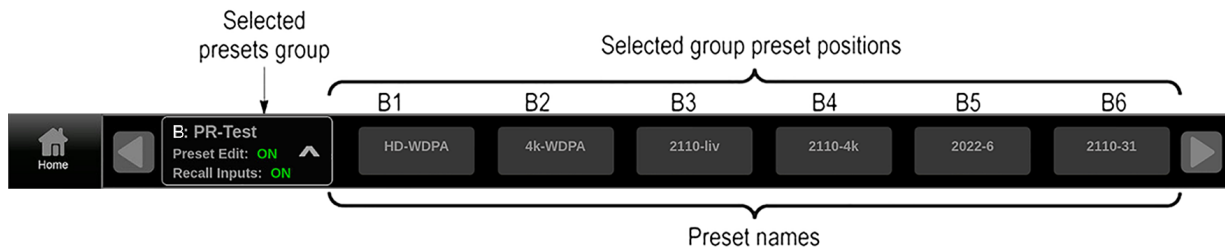

2. Find the preset to recall. Use the arrow buttons (◀ and ▶) or swipe left or right to move to the preset group (A–F).

Note: When a preset has no content, <empty> is displayed on the preset button.

3. Select the preset button to recall.

The selected preset button is highlighted and the instrument settings change to those assigned to the selected preset.

4. Select the Home icon (🏠) to close the Preset selection menu.

Note: If the Edit Mode is on, select the preset to recall and then select **Recall** from the menu.

Use Preset Menu Options

This menu has several options instead of using the Settings menu:

1. Select the Preset Menu button to open the Preset menu.

- Turn the Preset Edit Mode on or off; set the option to On or Off as needed.
- Turn the Recall Saved Inputs on or off; set the option to On or Off as needed.
For details on the Recall Saved Inputs option, see [Recall Presets without Inputs](#).
- Rename the preset group:
 - i. Select **Rename Preset Group**. To change individual preset names, see An on-screen keyboard appears.
 - ii. Rename the current group name with the on-screen keyboard or a physical keyboard.
 - iii. Select **Save** to save the new name or close the window to cancel the change.



2. Select the Preset Menu button a second time to close the menu.

Recall Presets without Inputs

Presets contain all PRISM settings including input configuration. Turning off the Recall Saved Inputs setting allows the presets to be recalled without recalling any of the input settings (video, audio, data). In this mode only the application and other settings are recalled.

Note: The preset still has all of the input settings, they are just not applied when the Recalled Saved Inputs setting is off.

1. Select the **Settings** icon () to open the Settings menu.
2. Select **Presets** to open the Presets submenu.

3. Set the Recall Saved Inputs to **Off**.

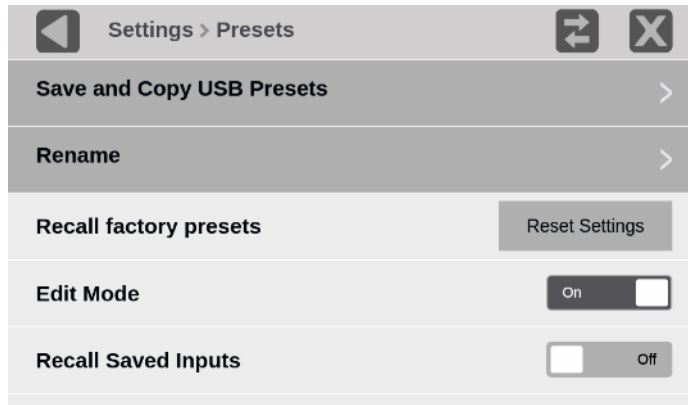

Recall Factory Presets

1. Select the **Settings** icon () to open the Settings menu.
2. Select **Presets** to open the Presets submenu.
3. Select **Reset Settings**.

A confirmation box opens.

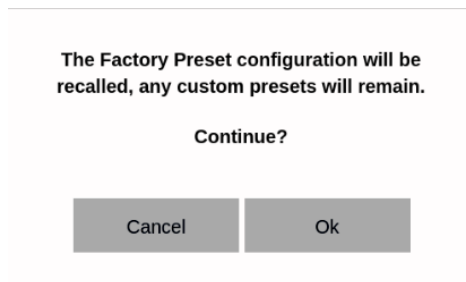

4. Select **OK** to confirm the selection and to reset the instrument settings to the factory defaults. The next table lists some of the settings that are reset.

Note: Custom presets are still available after recalling the factory preset.

Instrument settings reset by Recall factory preset

Item	Setting
Tile 1 application	Waveform
Tile 2 application	Video Session
Tile 3 application	Picture
Tile 4 application	Audio

Instrument settings reset by Recall factory preset

Item	Setting
SDI-In 1 input configuration	
Input name	SDI-In 1
Input type	SDI
Input connector	SDI 1
SDI-In 2 input configuration	
Input name	SDI-In 2
Input type	SDI
Input connector	SDI 2
SDI-In 3 input configuration	
Input name	SDI-In 3
Input type	SDI
Input connector	SDI 3
SDI-In 4 input configuration	
Input name	SDI-In 4
Input type	SDI
Input connector	SDI 4
SDI-In 5 input configuration	
Input name	SDI-In 5
Input type	SDI
Input connector	SDI 1
SDI-In 6 input configuration	
Input name	SDI-In 6
Input type	SDI
Input connector	SDI 2
PTP reference configuration	
PTP Logging to the Event Log	Enabled
Selected Profile	ST 2059
ST 2059 domain	127
ST 2059 communication mode	Multicast

Instrument settings reset by Recall factory preset

Item	Setting
SDI Generator configuration Enable SDI Generator	Disabled
IP Generator configuration Enable IP ST 2110 Generator Reference	Disabled Internal

Set Syslog Setup

Note: PRISM supports Syslog protocol (RFC 5424) for alarms and events.

1. Select the **Settings** icon (⚙️) to open the Settings menu.
2. Select **Network** and then select **REMOTE ACCESS**.

STATUS	CONTROL IP PORT	VIDEO IP PORT	REMOTE ACCESS	NMOS
Hostname		mpi2-25		
Password		PRISM		
SYSLOG SETUP				
Syslog Server Address		10.101.3.116		
Syslog Server Port		514		
Syslog Set		Clear	Save	

3. Fill in Syslog Server Address with the IP address of the computer running the syslog server software.
4. Fill in Syslog Server Port with the number configured in the syslog server software.

Note: For questions on configuring your syslog server software, contact your system administrator.

5. Select **Save**.

The syslog server software collects events and alarms, and displays the details.

Date	Time	Priority	Hostname	Message
03-12-2021	17:01:49	User.Info	10.101.3.118	Mar 12 16:52:27 mpi2-25-mastercontrol Prism[2228]: Audio Pair Out Of Phase :: Clear at time 2021-03-13 00:52:27 timecode 01:00:29:27 (LTC)
03-12-2021	17:01:48	User.Info	10.101.3.118	Mar 12 16:52:26 mpi2-25-mastercontrol Prism[2228]: Video signal lost :: Clear at time 2021-03-13 00:52:27 timecode 01:00:29:11 (LTC)
03-12-2021	17:01:48	User.Error	10.101.3.118	Mar 12 16:52:26 mpi2-25-mastercontrol Prism[2228]: Video signal lost :: Set at time 2021-03-13 00:52:27 timecode 01:00:29:11 (LTC)
03-12-2021	17:01:48	User.Error	10.101.3.118	Mar 12 16:52:26 mpi2-25-mastercontrol Prism[2228]: Audio Pair Out Of Phase :: Set at time 2021-03-13 00:52:26 timecode 01:00:28:29 (LTC)
03-12-2021	17:01:48	User.Info	10.101.3.118	Mar 12 16:52:26 mpi2-25-mastercontrol Prism[2228]: Audio Signal Lost :: Clear at time 2021-03-13 00:52:26 timecode 01:00:28:28 (LTC)

SNMP Functionality

This section explains how to use and set the SNMP controls and traps (alarms).

SNMP Web UI Controls

This section explains how to configure SNMP through a web browser.

1. Go to the PRISM homepage (enter the PRISM IP address in a web browser).
2. Select **SNMP** and set the Enable SNMP Traps to **Enable**.
3. Fill in the Trap Destination and Trap Community String fields.
4. Select **Download** to download the SNMP MIB.

SNMP Traps

PRISM supports SNMP only for alarms (traps). PRISM supports a single trap prefix (prismTrap), which can be seen in the Video signal lost sample. The SNMP configuration is created through the RESTful API.

- The alarm is identified in the SNMP trap payload.
- The PRISM SNMP MIB is provided in the file prism_mon.mib file, which can be downloaded from the PRISM web page.
- SNMP trap destination address is set with RESTful API using post operation, through Postman or a similar application.
- The alarms generated in the PRISM are sent to the destination trap receiver as a single SNMP trap.
- Users must have a trap receiver running on the destination machine and the IP address of the PRISM (snmpAgent) need to be configured with the destination IP address.

Enable Restful API SNMP Controls

Note: To open the PRISM help page, go to <http://IpAddress/api/help> (replace "IpAddress" with your PRISM IP address).

Note: To set the SNMP_TRAP_ENABLE_ON you need an API development application, such as Postman.

1. In a PRISM open an API development application, such as Postman.
 - GET and POST are allowed commands.
 - In these examples, replace "aaa.aaa.aaa.aaa" with the IP address of the PRISM the sending the traps and "bbb.bbb.bbb.bbb" with the IP address of the computer receiving the traps.

2. Set the SNMP_TRAP_ENABLE_ON:

A. Enter the IP address of the unit `aaa.aaa.aaa.aaa/api/snmp_trap_enable`.

B. In the body of the JSON command, enter:

```
{
  "ints": [
    "SNMP_TRAP_ENABLE_ON"
  ]
}
```

C. Execute as a POST operation.

3. Set the trap destination address:

A. Enter command `aaa.aaa.aaa.aaa/api/snmp_trap_destination_address`.

B. In the body of the JSON command, enter:

```
{
  "string": "bbb.bbb.bbb.bbb"
}
```

C. Execute as a POST operation.

4. Set the SNMP community string:

A. Enter the address of the unit `aaa.aaa.aaa.aaa/api/snmp_trap_community`.

B. In the body of the JSON command, enter:

```
{
  "string" :
  "new_trap_community"
}
```

C. Execute as a POST operation.

Check the Traps

1. Download the prism_mon.mib from the PRISM web page.
 - A. Open the PRISM instrument home page.
 - B. Enter the PRISM IP address in a browser.
 - C. Select **SNMP** in the PRISM menu.
 - D. Select **Download**.

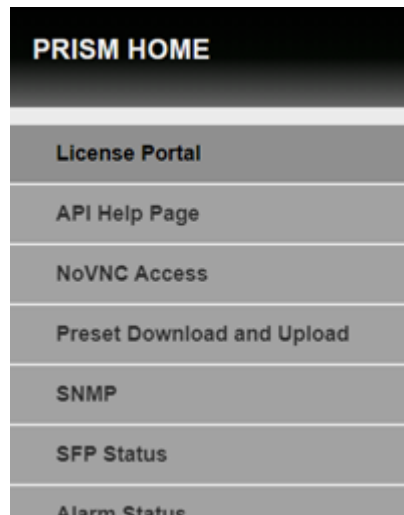

2. Install any SNMP manager on the machine where you want to check the traps.
 - A. From the SNMP manager, configure the SNMP agent (PRISM) IP address.
 - B. Load the prism.mib file.
 - C. Open the trap receiver window.
 - D. Confirm the traps are received on the trap receiver window of the MIB browser application on the destination machine (on port 162).

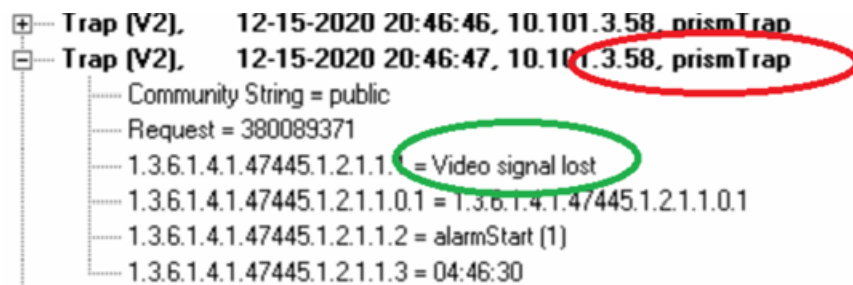

Alarms

Alarms are always operational and logged (with a few exceptions). They are also optionally sent to a syslog server or SNMP client. For each alarm group or individual alarm, you can also enable presentation on the Activity Dashboard.

Many alarms also have user-definable thresholds to set specific limits for the alarm.

Configure Alarms

Select the **Settings** icon (⚙️), and then select **Alarms**.

- To turn on the group of alarms, select the checkbox under Dashboard for the group.
- To reset the thresholds for a group of alarms, select the reset icon (↺) under Threshold for the group.

	Threshold	Dashboard
ANC Session	↺	☑️
Audio	↺	☑️
CC / Subtitles	↺	☑️
Gamut	↺	☑️
HDR	↺	☑️
IP	↺	☑️
Timing	↺	☑️
Video Session	↺	☑️

Select Specific Alarm

1. Select the **Settings** icon (⚙️), select **Alarms**, and then select the alarm group that contains the specific alarm.

2. Select the UI checkbox of the alarm to monitor.

Alarm	Threshold	Dashboard
Audio Over Error	>0 dB for >1 s	<input checked="" type="checkbox"/>
Audio Pair Out of Phase	<-30% for >1 s	<input type="checkbox"/>
Audio Signal Lost	N/A	<input type="checkbox"/>

Change Alarm Threshold

Note: If the alarm shows information in the Threshold column (not N/A), you can change the setting.

1. Select the alarm title.
The Thresholds option displays.
2. Select the arrows to change the threshold settings.

Depending on the alarm selected, there could be from one to four thresholds.

Alarm	Threshold	Dashboard
Audio Over Error	>-2 dB for >1 s	<input checked="" type="checkbox"/>
Duration <input type="text" value="1"/> s		
Max <input type="text" value="-2"/> dB		
Audio Pair Out of Phase	<-30% for >1 s	<input checked="" type="checkbox"/>
Audio Signal Lost	N/A	<input checked="" type="checkbox"/>

All Alarms

This lists all the available alarms by group with the individual alarm titles in bold. And there are descriptions of each alarm and what parts of alarms can be set, if any.

ANC Session

Duplicate SCTE104 Message: A copy of an SCTE104 packet has been received as seen on the ANC Session application.

SCTE104 Message: An SCTE104 packet has been received as seen on the ANC Session application.

Audio

Audio Over Error: Audio signal is at or above the specified Max audio level for a time longer than the Duration setting. Duration and the Max decibels of the audio can be set.

Audio Pair Out of Phase: Currently selected channels displayed in Lissajous have the channel correlation at or below the specified percentage for a time longer than the duration setting. Duration and the Min percentage of the audio pair phase can be set. See [Audio Pair Out of Phase Alarm Description](#).

Audio Sample Peak: Max dBFS can be set.

Audio Signal Lost: No Audio is present in the currently active signal.

Audio Silence Error: Duration in seconds and Min dB can be set.

Audio True Peak: Max dBTP can be set.

Loudness Dialogue Meas: Max dialnorm can be set.

Loudness Infinite: Max and Min LKFS/LUFS can be set.

Loudness Momentary: Max LKFS/LUFS can be set.

Loudness Range: Min LU can be set.

Loudness Short: Max LKFS/LUFS can be set.

Loudness Speech: Min % can be set.

CC (Closed Captions) / Subtitles

ARIB Closed Captions Lost: No valid ARIB closed caption packets in the ancillary data space were found. Duration of the loss can be set.

CEA708 Closed Captions Lost: No valid CEA708 closed caption packets in the ancillary data space were found. Duration of the loss can be set.

OP-47 Multipacket Teletext Lost: No valid Operational Practice 47 multi data packets were found in the ancillary data space of the signal. Duration of the loss can be set.

OP-47 SDP Teletext Lost: No valid Operational Practice 47 SDP data packets were found in the ancillary data space of the signal. Duration of the loss can be set.

CC (Closed Captions) / Subtitles (continued)

S334-1 CEA608 Closed Captions Lost: No valid ST 334-1 CEA 608 closed caption packets were found in the ancillary data space. Duration of the loss can be set.

S334-2 CEA608 Closed Captions Lost: No valid ST 334-2 CEA 608 closed caption packets were found in the ancillary data space. Duration of the loss can be set.

SMPTE 2031 Teletext Lost: No valid ST 2031 ANC data packets were found in the ancillary data space. Duration of the loss can be set.

Gamut

Input signal contains colors that violate the set limits for YRGB gamut thresholds. Set limits: YRGB minimum and maximum, Picture Area percent, and Frame Duration. See [Gamut Alarm](#).

HDR

Note: If you are using an MPI or MPX (not an MPI2 or MPX2) that is upgraded with a -25 multi-media board, the HDR alarms are not supported. The HDR alarms are visible in the alarms list and you can adjust the HDR alarm settings, but no HDR alarm will be generated or logged.

Note: These errors relate to the information displayed in the Measurement Overlay. See [Measurement Overlay: Details](#).

To turn on the HDR alarms, in Settings () in Alarms, set Enable HDR Alarms to **On**.

Area HDR Percent: Area of the video image that is in the HDR Zone (above HDR Zone Threshold Nits). This is the value reported by the "% HDR Area" in the Picture Measurements overlay.

To set the HDR Zone Threshold, go to the Measurement Thresholds in Picture Settings.

Area Percent Nits: Percent of the area of the active video that is above the specified threshold (in nits) for more than the specified duration.

To set the Area (%), go to the Measurement Thresholds in Picture settings.

Brightest Percent Nits: Brightest percent of the active video that is above the specified threshold (in nits) for more than the specified duration.

To set the Brightest Area (%), go to the Measurement Thresholds in Picture settings.

Contrast Ratio: Contrast ratio of the video is above or below the specified thresholds for more than the specified duration.

Darkest Percent Nits: Darkest percent of the active video is above the specified threshold (in nits) for more than the specified duration.

To set the Darkest Area (%), go to the Measurement Thresholds in Picture settings.

Dynamic Range: Dynamic range of the video is above or below the specified thresholds for more than the specified duration.

IP

Combined RTP Sequence Error: RTP sequence error occurred in the combined output of a media stream protected using RTP packet reordering or ST 2022.7 seamless switching.

Data Rate Invalid or Unstable: Detected data rate of a video input is unstable or nonstandard.

Ethernet BER Excessive: Excessive bit-error rate has been detected on Ethernet interface.

IP (continued)

Ethernet Buffer Overflow: Overflow was detected on IP Video Ports.

Ethernet CRC Error: CRC error was detected in an Ethernet frame.

Ethernet Interface Saturated: Ethernet interface is saturated.

HBRMT Header Invalid: Error occurred in the HBRMT header.

HBRMT Sequence Error: Packets are dropped, out of order, or duplicated; or a sequence number in a flow does not change.

HBRMT Timestamp Error: HBRMT timestamp is corrupt or is not updating at the correct frequency for the specified media type.

L4 Protocol Checksum Error: Checksum error was detected in an IP or UDP packet.

Network Connection Lost: Fiber connection to SFP port has been removed or FEC mode is in the wrong state.

RTP Header Invalid: Error occurred in the RTP header.

RTP Marker Frequency Error: RTP marker bit is not designated at the correct frequency for the specified media type.

RTP Sequence Error: Sequence errors can be caused by dropped, out of order, or duplicated packets. They can also be triggered when the sequence number within a flow does not change.

RTP Timestamp Error: RTP timestamp is corrupt or is not updating at the correct frequency for the specified media type.

S2022.7 Path Missing: One of the data paths in a ST 2022-7 seamless switching configuration is missing.

Timing

External Reference Lost: External reference signal is not detected.

Link Timing Error: Timing difference between any two links exceeds 400 nanoseconds, according to ST 425-6 2014.

PTP Unlocked: PTP is unlocked or missing.

Timing Drift: Input signal is not frequency locked to the reference signal. Drift rate is more than 10 us of timing change on a 20-second window, larger drift rates are detected faster.

Video and Reference Mismatch: Detected format of the external reference signal is not compatible with the input signal format.

Video Session

Format Unsupported: Detected video format is not supported.

Inter-link Format Mismatch: Four links of a quad-link signal are not the same format.

SD Video Detected: Detected video format is standard definition, for example 525 or 625.

SDI Active Field Length Error: Input signal is not frequency locked to the reference signal

Video Session (continued)

SDI C-channel ANC Checksum Error: Displays the status of the C channel ancillary embedded checksum value that was calculated for the video signal. Using a known test signal, the checksum status can be used to verify integrity through a system. An error means that the C Channel embedded checksum value does not match the calculated checksum value, which indicates that a transmission error has occurred.

SDI C-channel CRC Error: Displays the status of the C channel embedded CRC (Cyclical Redundancy Check) that was calculated for the video signal. Using a known test signal, the CRC status can be used to verify integrity through a system. An error means that the C Channel embedded CRC value does not match the calculated CRC value, which indicates that a transmission error has occurred.

SDI EAV Placement Error: SDI End-of-Active Video placement error has occurred.

SDI EDH Active Picture CRC Error: RP165 AP CRC value embedded in the data stream differs from the calculated CRC, or that it has been marked as invalid in the EDH packet, indicating there are EDH errors in the active picture.

SDI EDH Full-Field CRC Error: RP165 FF CRC embedded value differs from the calculated CRC value (or that it has been marked as invalid in the EDH packet), indicating that there are EDH errors in the full field.

SDI Line Length Error: Incorrect encoded transport line number was detected.

SDI Line Number Error: Incorrect encoded transport line number was detected.

SDI SAV Placement Error: SDI Start-of-Active Video placement error has occurred.

SDI Total Field Length Error: The total field length of SDI video is incorrect.

SDI Y-channel ANC Checksum Error: Displays the status of the Y channel ancillary embedded checksum value that was calculated for the video signal. Using a known test signal, the checksum status can be used to verify integrity through a system. An error means that the Y Channel embedded checksum value does not match the calculated checksum value, which indicates that a transmission error has occurred.

SDI Y-channel CRC Error: Displays the status of the Y channel embedded CRC (Cyclical Redundancy Check) that was calculated for the video signal. Using a known test signal, the CRC status can be used to verify integrity through a system. An error means that the Y Channel embedded CRC value does not match the calculated CRC value, which indicates that a transmission error has occurred.

SMPTE 352M Payload ID Missing: A mandatory ST 352M video payload identifier packet is missing.

Video Format Changed: TRS count performed by the instrument does not agree with the line number embedded in the 292M line.

Video Format Mismatch: Detected format of the video-input signal does not match the Input Format setting (which is set to a specific line rate, rather than being set to Auto) in the SDI Input submenu of the Configure menu or the setting specified in the ST 352 payload (if present).

Video Signal Lost: Video input signal has not been detected at the selected input.

Alarm Descriptions

This section has more details about certain alarms.

Audio Pair Out of Phase Alarm Description

The Audio Pair Out of Phase alarm warns if the audio signals in a pair are out of phase, according to set duration and percentage of phase.

The example alarm is set for 1 second duration of -30%.

Alarm	Threshold	Dashboard
Audio Over Error	>-2 dB for >1 s	<input checked="" type="checkbox"/>
Audio Pair Out of Phase	<-30% for >1 s	<input checked="" type="checkbox"/>
Duration	1 s	
Min	-30 %	
Audio Signal Lost	N/A	<input checked="" type="checkbox"/>

The percentage describes the location on the correlation meter (below the lissajous image) in the Audio application. So long as the phase marker (green diamond) does not drop below -30% (in the example setting) for more than a second, the alarm will not occur.

Note: The midpoint of the correlation meter is 0. Far left is -1 or -100%, which is out of phase. Far right is +1 or +100%, which is in phase.

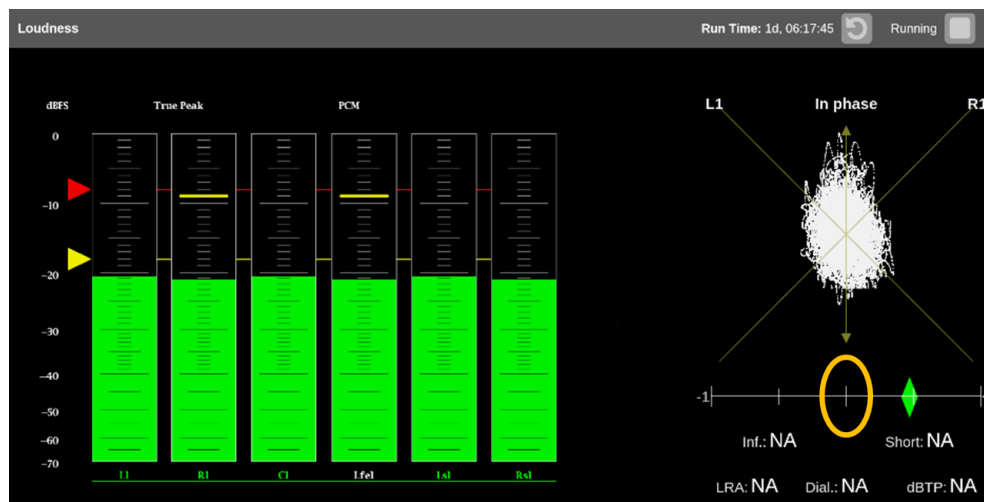

Gamut Alarm

The gamut alarm indicates when the input signal contains colors that violate the currently set limits for YRGB gamut thresholds, which are specified by the Settings/Alarms/Gamut. These measurements conform to the EBU R103 V3 standard.

Enable Gamut Alarm: Set to **Off** to disable gamut measurements and minimize CPU loading for quieter operation.

Gamut Preset: Select **EBU R103** to reset the gamut measurements to the EBU R103 V3 defaults.

The Gamut Preset only resets the YRGB thresholds, not the Picture Area or Frame Duration.

Thresholds can be displayed in either 10-bit or 12-bit representation.

YRGB: Select the line to set Min and Max.

Picture Area: Select anywhere in the line to open the control to set a percentage.

Frame Duration: Select anywhere in the line to open the control to set the number of frames.

	10-bit	12-bit	Threshold	Dashboard
YRGB		Min 20d (-5% = -35mv)	Max 984d (105% = 735mv)	Narrow 10-bit <input checked="" type="checkbox"/>
Picture Area			1 %	
			▼ 1 ▲ %	
Frame Duration			1 frames	

Gamut Alarms are reported in the Event Log application in the format:

Gamut Violation: Max YRGB, Min yrgb, Area xx.x%

- Max YRGB: violation for Y, R, G, or B components, violations are marked by an uppercase component letter. Underscores are used when no violations are found.
- Min yrgb: violation for Y, R, G, or B components, violations are marked by a lowercase component letter. Underscores are used when no violations are found.

- Area: the percent of the active picture that is in violation for one component. This is only the component with the most violation, not all components together.

Limits: Max xxxd, Min xxxd, >x% Area, >X Frames

These limits were in effect when the alarm was asserted.

In this example:

- Max has violations in G and B. Min has violations in the y, r, g, and b components. The component with the most violation covers 0.9% of the active picture.
- Gamut Maximum is set to 984d, the Minimum Threshold is set to 20d, the Picture Area is set to 1 percent, and the Frames Duration is set to 1.



Note: When Gamut is disabled, no Gamut alarms are generated or logged.

Gamut measurements are not supported for psF, 3G Level-B, SQD, or 8K input signals.

Adjust Display

The Display has settings for screen labels when multi input is used and settings for trace and graticule intensity. It also has controls for extended display, which are explained in the [Display Operation](#) section of the manual.

Set Source Label

When multi input is used, it is possible to define where and how the on-screen labels appear:

1. Select the **Settings** icon () to open the Settings menu.
2. Select **Display** to open the Display submenu.
3. Select **MULTI INPUT**.

The Multi Input menu appears.

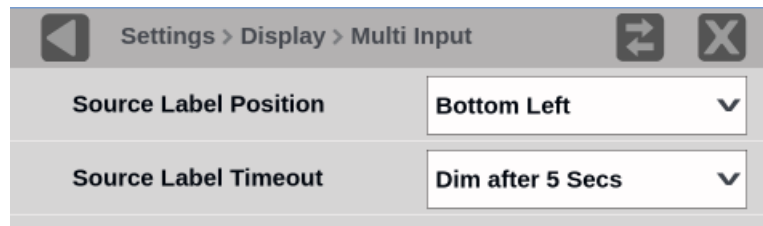

Note: These options can be set if multi input is on or off.

Source Label Position

There are two methods to change the location of the on-screen, multi-input label (visible when Multi Input is on):

- In the Multi Input page, select the Source Label Position menu and choose the location of the display.
- In a tile, select a label and drag it to one of the four corners of the tile. All other labels in the other tiles will automatically change to match.

Source Label Timeout

To change the action of the labels (if they disappear, how long to disappear), select the Source Label Timeout menu and select from the options. This settings affects all tile labels.

Set Safe Area Graticules

When safe-area graticules are used, it is possible to define where and how the Picture application on-screen graticules appear.

1. Select the **Settings** icon () to open the Settings menu.
2. Select **Display** to open the Display submenu.
3. Select **SAFE AREA GRATICULES**.

The Safe Area Graticules menu appears.

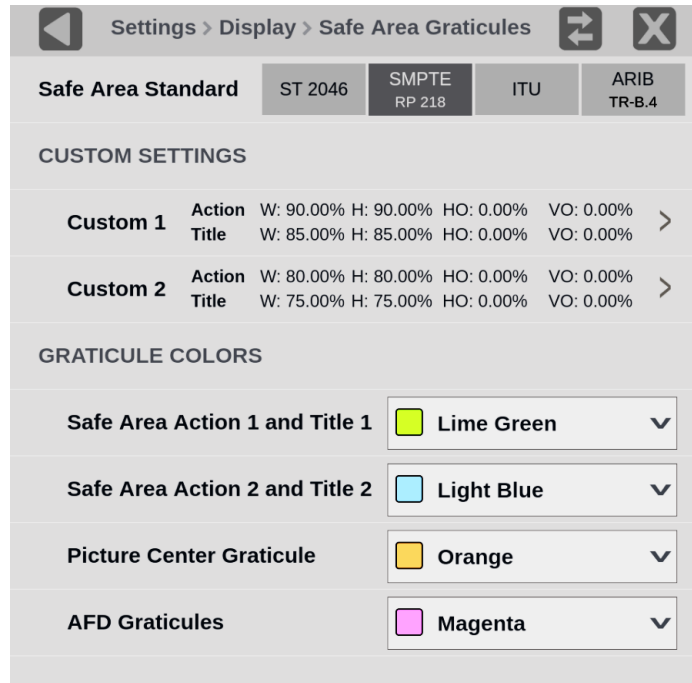

Select Standard Safe Area

In the Safe Area Graticules menu, select a standard from the Safe Area Standard menu options: ST 2046, RP 218, ITU, or ARIB TR-B.4.

The safe areas must be turned on in a Picture tile to appear. To turn on the selected safe areas, see [Select Safe Area Graticules](#).

Set Custom Safe Areas

1. In the Safe Area Graticules menu, select anywhere in the Custom 1 or Custom 2 line to open the settings.

The Custom # menu opens.

Section	Parameter	Value
SAFE ACTION	Width (%)	90.00
	Height (%)	90.97
	Horizontal Offset (%)	2.60
	Vertical Offset (%)	-0.70
SAFE TITLE	Width (%)	85.00
	Height (%)	85.00
	Horizontal Offset (%)	0.00

Buttons: Cancel, Save Custom 1

2. Update the Width and Height settings as needed.

- Select in the Width or Height fields and enter a percent number up to the hundredths place.
- Or select the up or down arrows to set the numbers.

The arrows change the number by hundredths. Hold the arrow to change the number faster.

Note: The percent number is the percent of the image (active height or width) the custom frame will surround.

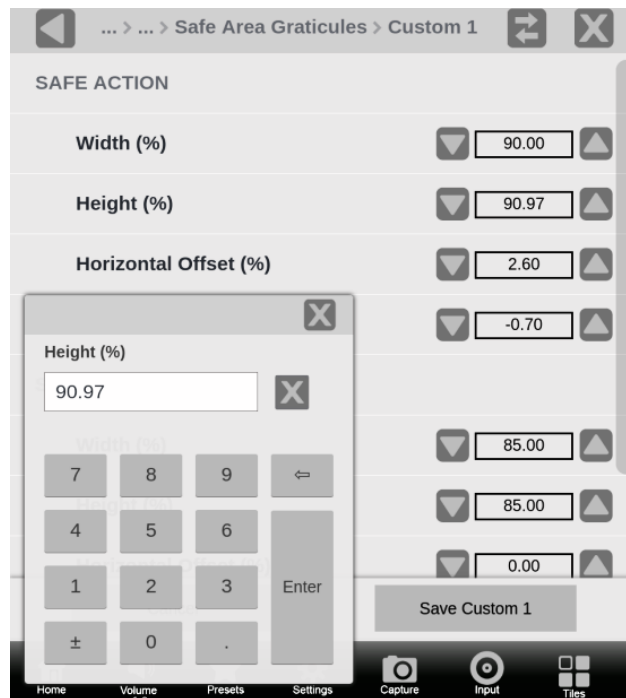

The SAFE ACTION frame turns on a solid line in the Picture tile.

The SAFE TITLE frame turns on a dashed line in the Picture tile.

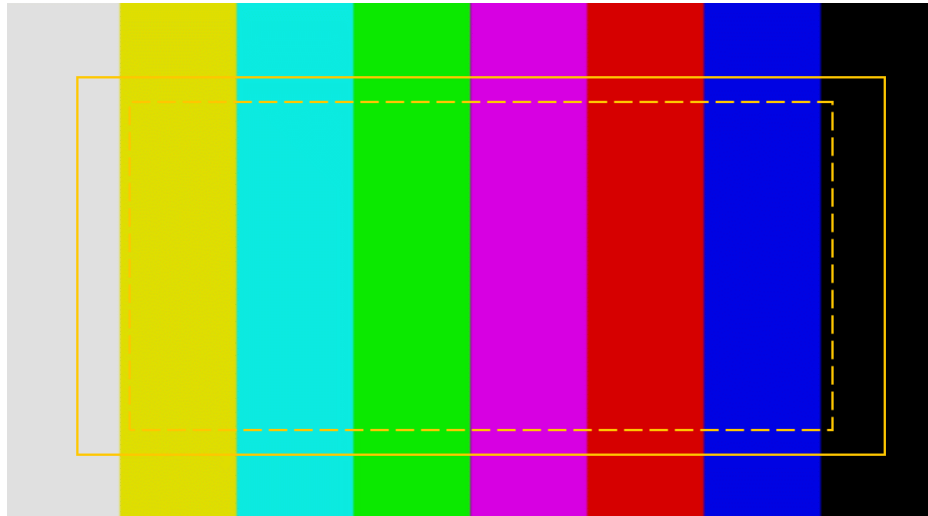

Note: Because the safe area is defined by percent of the image, the image format does not affect the marked area. For example, 90% of the height of the image is 90% for 1280 x 720 or 4096x2160.

1. If the frame needs to be moved off center in any direction, select in the Horizontal or Vertical Offset fields and enter the percent of the frame to move the safe area.
 - Select the \pm symbol in the on-screen keypad to switch between positive and negative numbers.
 - To move the frame horizontally, positive numbers move the frame to the right, negative numbers move the frame to the left.
 - To move the frame vertically, positive numbers move the frame down, negative numbers move the frame up.

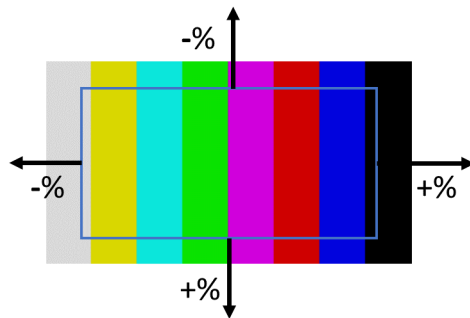

- If the Offset takes a graticule frame outside the Picture tile, the border (solid or dashed) is visible at the edge of the tile (whatever side the frame is off) while the rest of the frame is smaller, as if the entire frame is visible.

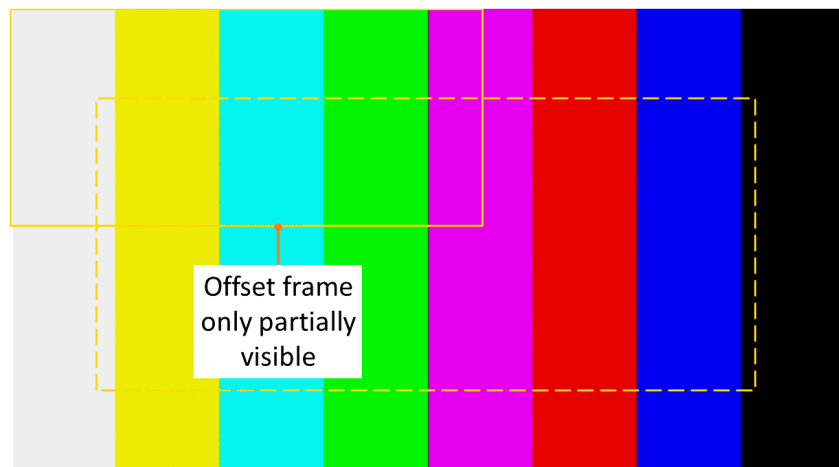

2. Select **Save Custom #**.

The Custom Safe Areas (Action and Title) are updated in the selected Picture tile when they are turned on in the Picture settings menu.

To turn on Custom Safe Areas, see [Select Safe Area Graticules](#).

Set Graticule Colors

1. Select the **Settings** icon () to open the Settings menu.

2. Select **Display and then select **SAFE AREA GRATICULES**.**

In the Safe Area Graticules menu, select the safe area element menu to select a color.

- Safe Area Action 1 and Title 1
This color is for both the Custom 1 Safe Area *Action* (solid line) and Custom 1 Safe Area *Title* (dashed line).
- Safe Area Action 2 and Title 2
This color is for both the Custom 2 Safe Area *Action* (solid line) and Custom 2 Safe Area *Title* (dashed line).
- Picture Center Graticule
This color is for the Picture Center Graticule.
- AFD Graticule
This color is for the AFD frame.

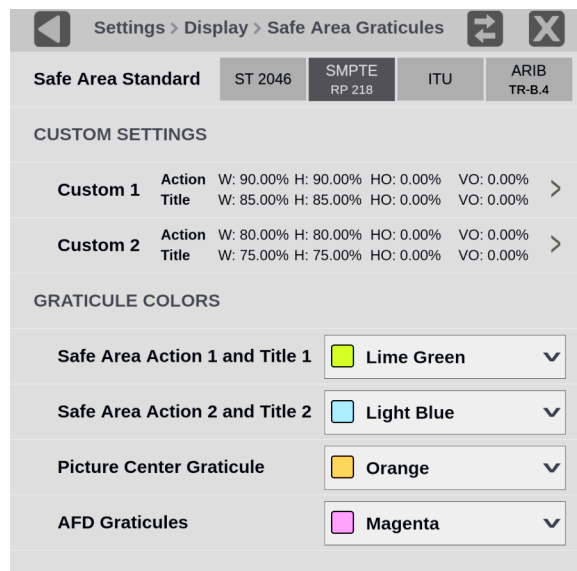

Set Trace and Graticule Intensity

The brightness of an application graticule and trace can be adjusted with the intensity controls in the Display settings menu.

To adjust graticule and trace intensity:

1. Select the **Settings** icon (⚙️) to open the Settings menu.
2. Select **Display** to open the Display submenu.
3. Select **TRACE AND GRATICULE INTENSITY**.

4. Select the plus icon (➤) to increase intensity or the minus icon (◀) to decrease intensity of the trace or graticules.

Note: The intensity can also be adjusted by selecting anywhere in the control or by selecting and dragging the selector circle left or right.

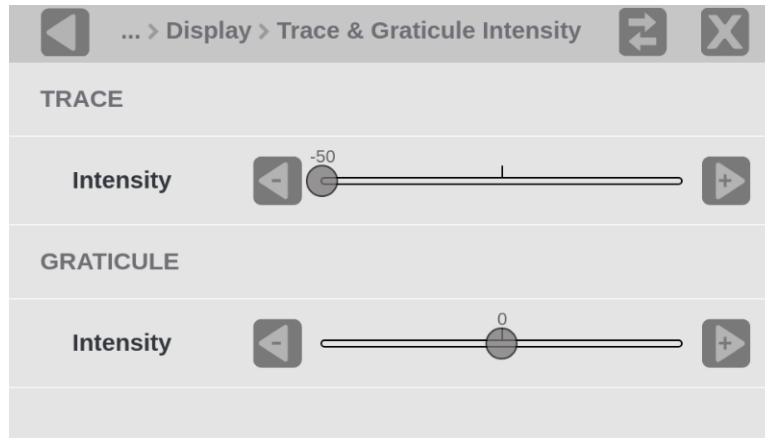

Set Time and Date

This section explains how to set the internal time and date used by the instrument to record events. It also explains how to change the clock available on the Status bar between PTP and RTC.

Note: When the time and date settings are changed, the instrument must be rebooted to implement the changes.

1. Select the **Settings** icon () to open the Settings menu.
2. Select **Utilities** to open the Utilities submenu.
3. Select **Time and Date** to open the submenu. The submenu has two tabs: TIME SETTINGS and RTC CLOCK.

Update Time Zone

1. In the Time and Date menu (to open the menu, see Set Time and Date), select **TIME SETTINGS** to open the submenu.

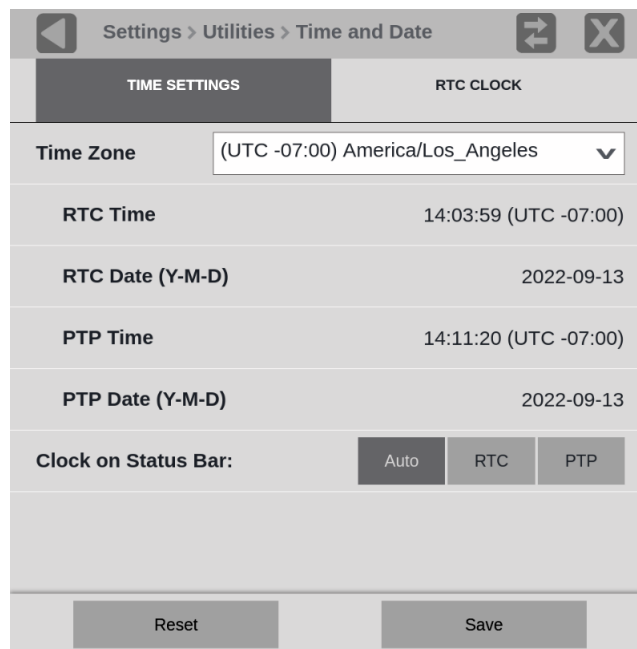

2. Select the Time Zone menu and select the correct time zone offset for your location. The selection names include the time offset from UTC and major cities in those time zones.
3. Select **Save** to update the clock. A reboot is not required to change the time zone.

Change Status Bar Clock

Note: The RTC or PTP clock in the Status Bar is automatically set to local time.

1. In the Time and Date menu (to open the menu, see Set Time and Date), select **TIME SETTINGS** to open the submenu.
2. In Clock on Status Bar, select Auto, RTC, or PTP.

Note: The Auto setting searches for a PTP signal and if one is not available, it selects RTC.

3. Select **Save**. A reboot is *not* required to change the Status bar clock.

Update RTC Clock

1. In the Date and Time menu (to open the menu, see [Set Time and Date](#)), select **RTC CLOCK** to open the submenu.
2. Adjust the time and date using the up and down arrows as needed.
The time setting uses a 24-hour clock, so no AM/PM setting is required.

Settings > Utilities > Time and Date

TIME SETTINGS | **RTC CLOCK**

Current Time 11:30:01 (UTC -07:00)

Current Date (Y-M-D) 2021-08-30

*Make sure Time Zone is properly set before adjusting Time and Date.

Time (H:M:S) 11 : 22 : 13

Date (Y-M-D) 2021 - 08 - 30

Reset Save

3. When you are done setting the time and date, select **Save**.

4. The message box asks you to confirm you want to reboot the instrument to implement the time and date changes:
 - Select **OK** to reboot the instrument immediately and implement the changes.
 - Select **Cancel** to end the operation.

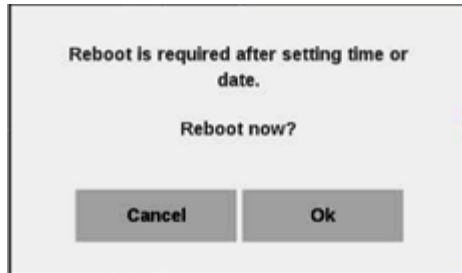

Upgrade Instrument Firmware

Telestream releases updates to product firmware to add new features or to fix reported problems. Check the Telestream website regularly for new firmware releases.

Before Upgrading



CAUTION: After upgrading to 4.0 or higher, do not downgrade the instrument to a version before version 4.0.

You do not need to perform a firmware upgrade if the instrument has the latest version of firmware already installed. To determine if the firmware on your instrument must be upgraded:

1. Power on the instrument.
2. Verify the current software version installed on the instrument:
 - A. Select the **Settings** icon () and select **Utilities**.
 - B. Select **Version** and in the Software section, make a note of the version number installed on the instrument.

Instrument firmware version number

3. Verify the latest version of firmware at the Telestream website:
 - A. Use a web browser and go to the Telestream website software page: www.telestream.net/video/resources.htm#Software.
 - B. Select the product and model title that best matches your instrument (such as PRISM) and in the list, find the software-upgrade package for your instrument.
 - C. Note the latest version number of the software-upgrade package(s).

Website firmware version number

4. If the latest firmware version at the website is newer than the version on your instrument, you should upgrade the firmware.
5. Select the Firmware Release version for your instrument to download the update.



CAUTION: After the instrument has started the upgrade process, DO NOT remove power from the instrument. If you do, the instrument flash will be corrupted. The instrument must be sent to a Telestream factory service center to have the system firmware restored.

6. Go to [Upgrade Firmware](#).

Note: The time required to complete the upgrade is about 15 minutes.

If you want the details of what has changed in the release, download the Release Notes for the version.

Note: If power to the instrument is lost before it begins erasing the internal flash, you can restart the firmware upgrade after the instrument reboots.

Upgrade Firmware

1. On an internet-enabled computer, prepare a formatted (FAT32), non-bootable USB drive. It needs 1 to 2 GB of available space.
2. Unzip the PRISM file and copy the upgrade file with a .ubin file extension from the upgrade package onto the USB drive.

Note: The upgrade package includes an MD5 checksum and a PDF file, read the PDF file before performing the upgrade. The file contains important information about the firmware release.

3. Remove the USB drive from the computer and insert the USB drive into a USB port on the PRISM monitor.
4. On the PRISM monitor, select the **Settings** icon () and select **Utilities**.
5. Select **Firmware Upgrade**. After the USB device has been scanned, the display lists all of the files on the USB device with a .ubin file extension.
6. Select the file in the list and then select **Install** to start the upgrade.

When the upgrade begins, a message box appears stating that the firmware installation is in progress.

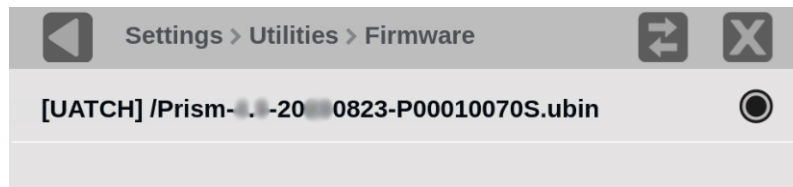



 **CAUTION:** Removing the USB device or powering off the instrument before the upgrade is complete can cause upgrade failure. To prevent upgrade failure, wait until the Installation Complete message box is displayed before performing these actions.

The upgrade may take up to five minutes.

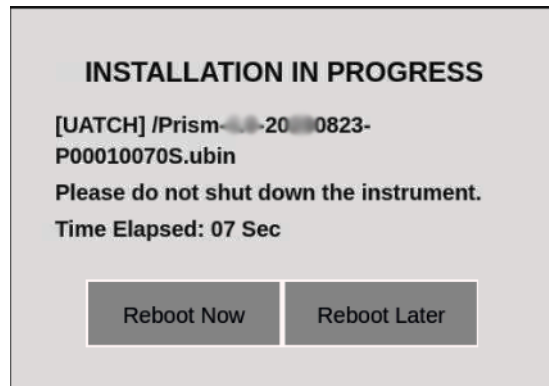
1. When the install is complete and the reboot options are available, select **Reboot Now**.



2. Select the **Activity** icon () to view the devices mounted to the instrument.
3. Select the **Eject** icon () to unmount the USB drive from the instrument.
4. Remove the USB device from the PRISM monitor.
5. Shut off the instrument:
 - A. Select the **Settings** icon () and select **Utilities**.
 - B. Select **Power** and select **Power Down Now**.
6. Disconnect the instrument from AC power.
7. Reconnect the instrument to AC power.
8. Press the power button on the instrument front panel to turn the instrument on.

Verify Firmware Upgrade

1. Select the **Settings** icon ()
2. Select **Utilities** and then select **Version**.
3. Verify the displayed firmware version number matches the version of the firmware upgrade package you installed.

Upgrade Software License

A software license upgrade allows you to add optional software features to your instrument. Go to www.telestream.net for the latest list of features that can be licensed

Install Software License Upgrade

To activate the licenses, the instrument must be accessible by another computer on the local network. Your instrument does not need to access the internet.

To activate the licenses:

1. Connect the PRISM instrument to a local network and turn power on.
2. After the instrument has powered on, find the IP address:
 - A. Select the **Settings** icon () and then select **Network**.
 - B. Select the **STATUS** tab and note the IP Address.
3. Enter the IP address in a web browser.
4. Select **License Portal** and follow the instructions on the page.

For further assistance, contact our technical support team:
www.telestream.net/telestream-support/video/support.htm.

Verify Software License Upgrade

1. Select the Settings icon () to open the Settings menu.
2. Select **Utilities** and then select **Options**.
3. Verify that the displayed options match the options you installed.



Troubleshooting

There are a few procedures for maintenance of a PRISM.

Create Diagnostics File

If the instrument needs service, you may be asked to provide the diagnostics file to Telestream to aid in understanding any problems with the instrument.

To download a zip file containing a service report of instrument diagnostics:

1. Select the **Settings** icon ()
2. Select **Utilities** and then select **Diagnostics**.
3. Insert a USB device into one of the USB ports on the PRISM instrument.
4. Select **Save Diagnostics** to save the diagnostics report to the USB device.
5. Select the Activity icon () and then select the **Eject** icon () to unmount the USB drive from the instrument.

Find PRISM Original Model

There are some conditions when it is necessary to know the original model of a PRISM, to tell if it has been upgraded.

To find the original model of a PRISM:

1. Select the **Settings** icon ()
2. Select **Utilities**, and then select **Option**.

3. The Nomenclature field lists the model it was shipped as, before any upgrades.
The first example shows an instrument that is an MPI.

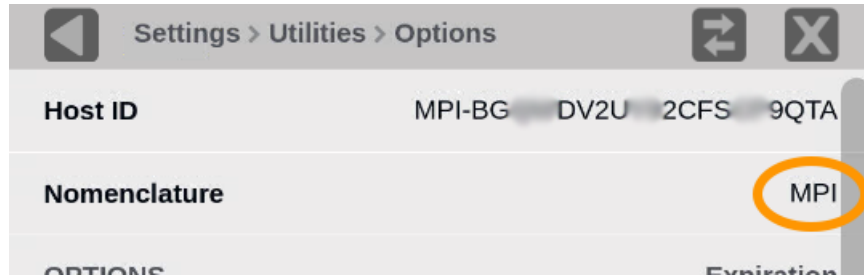

The second example shows an instrument that is an MPI2-25.

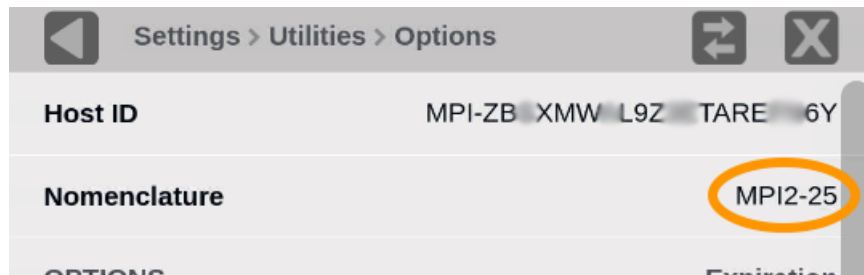

Functions

This section describes additional functions available on the PRISM monitor.

- Headphone and speaker volume, balance, source adjustment, and downmix
- Stream Capture

Headphone or Speaker Volume, Balance, Device, and Source Adjustment

Headphones can be connected to MPI2-25 or MPX2-25 products:

- MPI2-25 audio output rear panel connector
- MPX2-25 audio output rear panel connector or front panel headphone port

To access the volume, balance, and source controls, select the **Volume** icon ().

The available options:

- Select the audio device to use.
- Select the source from the list of available channel pairs.
- Use the control or arrow buttons to turn the volume up or down.
- Use the control or arrow buttons to adjust the audio balance left or right.
- Select the mute button to mute the audio.
- Select the downmix button to listen to a downmixed group of channels.

If the downmix button is not visible (the example shows the downmix button) the Program configuration might not be on or set.



Downmix Controls

Downmix combines channels to monitor them grouped as stereo or mono. There are several options for ways to hear combined channels.

Enable Downmix Button

Note: The Dolby program is configured automatically, based on metadata.

1. Select the **Settings** icon () to open the Settings menu.
2. Select **Inputs** to open the Inputs submenu.
3. Select the input with the channels to downmix.
 - A. If the input is SDI, select **AUDIO**.
 - B. If the input is 2022, select **AUDIO**.
4. Check the Program Configuration is on and configured for the input.
5. Select **Save**.

6. Select the **Volume** icon ().

The downmix button is visible.

Set Downmix Mode

With the downmix parameters set, select one of the Downmix Mode options in the Settings Audio menu:

1. Select the **Settings** icon () to open the Settings menu.
2. Select **Audio** to open the Audio submenu.

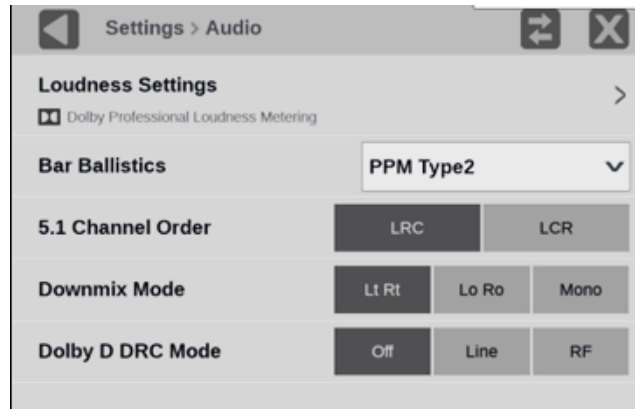

- **Lt Rt** (left-total and right-total, a stereo Pro Logic mix): Reduces the stream to 2 channels. The center channel is reduced 3dB, the surround channels are added together to create a single signal and reduced 6dB, and the LFE is muted. The surround signal is added 180 degrees out of phase to the left-and-center signal, making up the left-total channel. The surround signal is added *in* phase (0 degrees) to the right-and-center signal, making up the right-total channel.
- **Lo Ro** (left-only and right-only, a stereo only downmix): Reduces the stream to 2 channels. The center channel is reduced 3dB, both surround channels are reduced 3dB, and LFE is muted. The center channel is added to the left-and-left-surround signal to make the left-only channel. The center channel is added to the right-and-right-surround signal to make the right-only channel.
- **Mono**: Reduces the stream to one channel. The center channel is reduced 3dB, the surround channels are each reduced 3dB, and the LFE is muted. All 6 channels are combined.

Access Downmix Control for Input 2110-30 with Multiple Audio Streams

This section only applies to original MPI and MPX instruments that have been upgraded with a 25Gb media board. This does *not* affect MPI2-25 or MPX2-25 instruments, or MPI2-10 or MPX2-10 instruments upgraded with a 25Gb media board. To tell if an instrument has been upgraded, see [Find PRISM Original Model](#).

Note: In original MPI or MPX instruments upgraded with a 25Gb media board, the downmix is only available when input 2110-30 uses a single audio stream.

Enable single-stream downmix control:

1. Select the **Settings** icon () to open the Settings menu.
2. Select **Inputs** to open the Inputs submenu
3. Select the input from the audio signal to downmix.
4. Select **IP**, then select **ST2110**, and then select **Audio (2110-30)**.
5. If there are multiple enabled audio streams, disable all the streams except the stream you want to downmix.

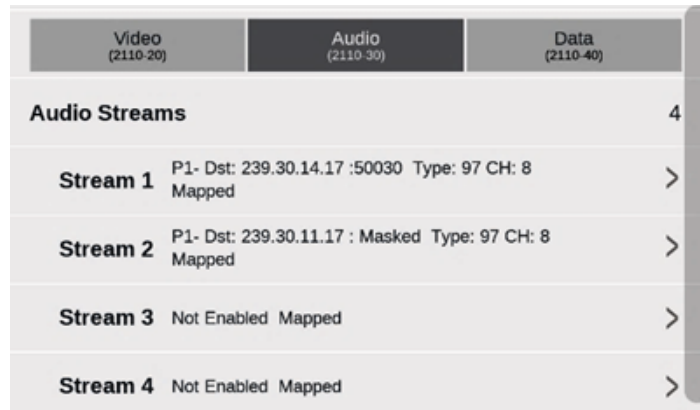

- A. Select a stream you do *not* want to hear and set Enable Audio Stream to **Disabled**.

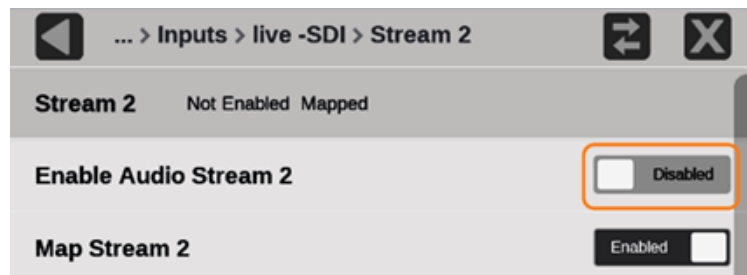

- B. Select **Save Stream**.
- C. Repeat steps *a* and *b* for all enabled streams except the stream you want to downmix.

Audio Controls

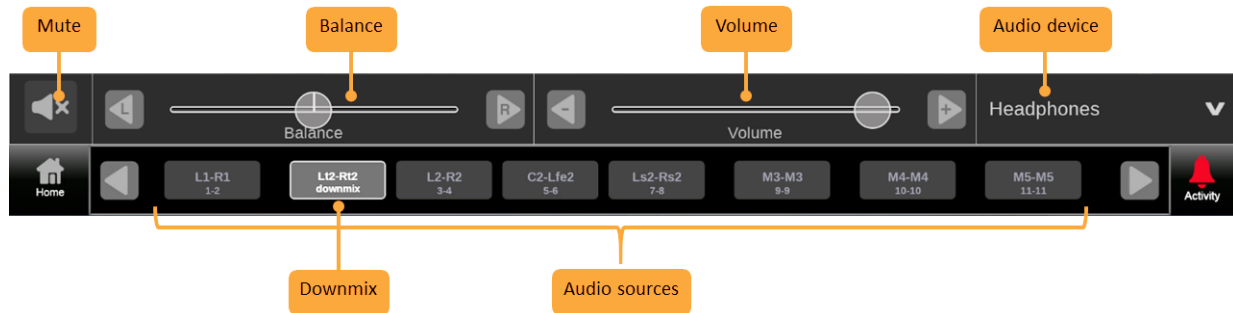

Audio control features and descriptions

Option	Description
Mute	Mute or unmute audio
Balance	Left and right balance control of selected audio pair
Volume	Volume control of selected audio pair
Audio device	Output audio device to control. This can be headphones using the audio ports or USB inputs. The name of the audio device in the list depends on what port is used and the device itself: Headphones: Headphones plugged into the front or rear panel audio ports USB AUDIO DAC: Headphones plugged into the external display product audio ports Unknown: Unidentified audio device plugged into the front or rear panel USB ports If a USB audio device supports device descriptors, the vendor supplied device name appears in the list.
Downmix	Audio channel group to monitor channels mixed down to stereo or mono (visible when only Program Configuration is on and set)
Audio sources	Audio channels available to monitor

⚠ WARNING: To avoid damaging your hearing, always turn the volume down to the minimum before you put on headphones and then turn the volume up slowly.

Capture

The Capture feature has two modes: Screenshot and Stream.

Screenshot capture takes an image of the entire screen and saves it to a USB drive.

Stream capture creates a PCAP file capturing up to 2 GB of data on a USB drive for further analysis. Both modes are useful for comparing sources or capturing transient events.

Requirements to use the Capture feature:

- MP2-IP-MEAS option installed
- USB 3.0 drive connected to the rear panel of the PRISM monitor

Note: For the fastest capture rate with the Stream Capture, we recommend using a USB 3.0 drive, plugged into one of the USB 3.0 ports on the rear panel of the instrument. Using a USB 2.0 drive or USB 2.0 ports can cause the stream capture to take longer.

Note: Maximum stream capture PCAP files are approximately 2 GB in size.

Capture Screenshot

1. From the Settings menu, select **Capture**.

Note: If the Capture configuration menu does not appear under the Settings menu, option MP2-IP-MEAS is not installed, but screen captures are still functional.

2. Select **Screenshot** under SELECT CAPTURE TYPE.

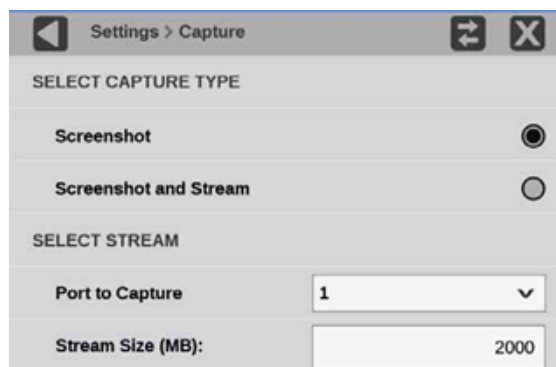

3. On the application bar, select the **Capture** icon ()



A screenshot is saved to the device.

Note: The screenshot API is for Telestream internal use only. If you need to remotely save a screenshot to a flash drive, use VNC.

Perform Stream Capture

1. Verify there is a USB drive connected to the PRISM monitor.
2. Select the **Settings** icon () and then select **Capture**.

Note: If the Capture configuration menu does not appear under the Settings menu, option MP2-IP-MEAS is not installed and stream captures are disabled.

3. Select **Screenshot and Stream** under SELECT CAPTURE TYPE.
4. Select the Port to Capture menu and select from inputs (10/25GE SFP) 1 or 2.

Note: When capturing on a port configured for 25-Gb data rate, the maximum total bit rate on the port must be less than 15 Gbps. Data packets captured in the PCAP file may be dropped if the total bit rate exceeds this limit.

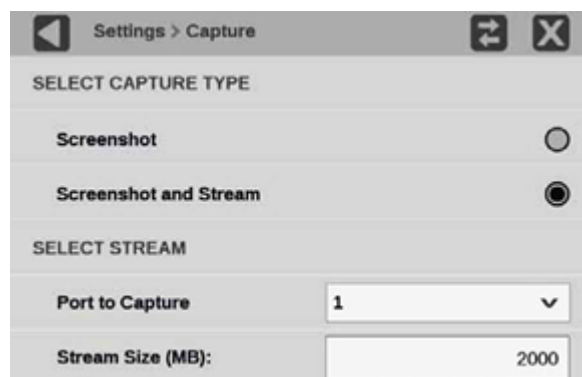

5. Select in the Stream Size (MB) field and set the size of the capture.

Note: The minimum stream size is 1MB and the maximum size is 2000 MB.

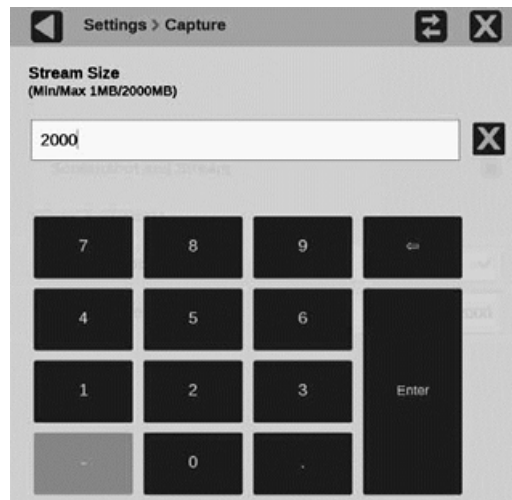

6. Select the close icon (X) to close the settings.

7. On the application bar, select the **Capture** icon (📷) to start the process. When the capture type is Screenshot and Stream, a percentage is displayed under the Capture icon.

Note: During capture the Aux Out signal is turned off, and Pictures and Traces are blanked.

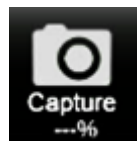



Note: Select the Capture icon again to stop the stream capture early. The Capture icon is the only element you can interact with on the PRISM monitor while the capture and save are taking place.

A screenshot and pcap file are saved to the attached USB drive. The name of the file and the path to the file on the USB drive are displayed after the save is complete.

8. Select **OK** to close the menu.

Application Information

This section describes the monitoring and measurement applications available on the PRISM monitor. Each of these applications can be viewed in quarter-screen, half-screen, or full-screen mode; double tap in the application to change between modes.

To see the All Application menu, select the **Tiles** icon () and then select the All Application menu icon ().

Note: Some displays require a specific option to be installed. For example, the IP Graph display is not accessible unless you have Option MP2-IP-MEAS.

Application Options

The applications are grouped in several options. These groups, and the general descriptions of the applications, are detailed in this section.

Base Instrument Applications

These applications are available on every PRISM monitor, unless otherwise noted:

Note: Of the trace applications (Waveform, Vector, Stop, Diamond, Lightning, and CIE) up to 8 can be displayed at the same time in formats: SD; HD 720p, 1080p, 1080i; 3G Level A. All other formats can display up to 4 trace applications at a time.

Application icons	Description
-------------------	-------------



Waveform Application: Use this application to view the voltage versus time display of the video signal.

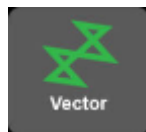

Vector Application: Use this application to call up the Vector, which plots color difference signals for viewing hue and amplitude, but not luminance.



Lightning Application: Use this application to show luma and chroma amplitudes and verify component timing using a color-bar signal.

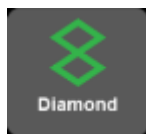

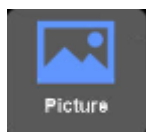

Diamond Application: Use this application to reliably detect invalid colors.

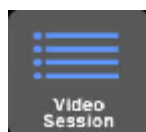

Picture Application: Use this application to view the picture decoded from the incoming video signal.



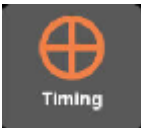

Video Session Application: Use this application to view information about the format of the signal and metrics for SDI Format, VPID ST 352, Bit Level, and CRC Status.

Application icons	Description
	Audio Application: Use this application to view audio bar levels for the monitored signal with Test Level and Peak Program indicators. (Lissajous display and Channel Correlation meter for monitoring two-channel audio phase and Audio session require Option MP2-AUD.)
	Event Log Application: Use this application to view a log of detected errors.
	IP Status Application: Use this application to see an overview of the monitored IP stream and see the status of each program in the stream.
	Timing Application: Use this application to view timing offsets between the incoming SDI video signals and Black Burst / Tri-Level Sync external reference signals.

Option MP2-PROD

This supports SDI and 2110 Deep Color formats, see tables [Supported SDI formats](#) and [Supported video formats in ST 2110-20 streams](#). It also supports this feature and these additional applications, which are available when option MP2-PROD is installed, unless otherwise noted:

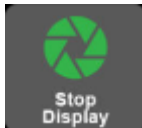
Convert to Rec. 709: This feature adds a setting to allow the trace displays to convert camera logs to Rec. 709.

Application icons	Description
	Stop Display Application: Use this application to monitor video signals with a variety of transfer functions in a consistent manner.
	CIE Application: Use this application to check the chromaticity of the video against various color gamut limits.

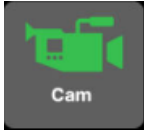

Option MP2-MULTI

This option enables monitoring up to 4 SDI inputs. Without this option only 1 SDI input can be monitored.

Application icons	Description
	<i>CAM Application:</i> Use this application to check the color levels and balances between up to four camera inputs.

Option MP2-AUD

This additional application is available when Option MP2-AUD is installed:



Application icons	Description
	<i>Audio Application:</i> This option adds Lissajou, Session, Correlation, and Loudness capabilities to the existing Audio application.
	<i>Dolby Status Application:</i> Use this application to show metadata content in the selected Dolby audio stream or carried in VANC data ST 2020.
	<i>AES Channel Status Application:</i> Use this application to see AES data related to the SDI input audio channels.

Option MP2-DLBY

This option enables full decoding of Dolby E, D, and D Plus signals. It also enables decoding of ED2 metadata.

Option MP2-ENG and MP2-QC

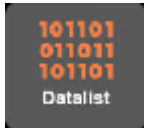

These additional applications are available when Option MP2-ENG or MP2-QC is installed, unless otherwise noted:

Application icons	Description
	<i>Picture Application:</i> This option adds the ability to decode and display closed captions or subtitles in CEA 608, CEA 708, OP47/ST2031, and ARIB B24 to the existing Picture application.
	<i>Datalist Application:</i> Use this application to see the digital data contained in SDI frames to perform in-depth monitoring and analysis of incoming SDI data.
	<i>ANC (Ancillary Data) Session Application:</i> Use this application to monitor all ancillary data present in a signal.
	<i>Audio-Video Delay Application:</i> Use this application to measure the audio-to-video synchronization (lip sync) when using a Flash Pop test sequence that can be generated from the Telestream Sync Pulse Generator.

Option MP2-IP-MEAS

These additional applications and feature are available when option MP2-IP-MEAS is installed, unless otherwise noted:

IP Stream Capture: This feature allows the capture IP streams to a PCAP file. The maximum capture size is 2 GB, which allows for the capture of 10 seconds of HD video.

Application icons	Description
	<i>IP Session Application:</i> Use this application to view various performance parameters of the IP stream including Layer 2, video, and PTP parameters.
	<i>IP Graphs Application:</i> Use this application to view trend graphs of various performance parameters of the IP stream including total bit rate, session bit rate, PIT, RTP sequence errors, video CRC errors, and TS-DF (Time Stamped Delay Factor).



PIT Histogram Application: Use this application to view a histogram of the PIT (Packet Interval Time) to monitor network delay variation statistics.



PTP Graphs Application: Use this application to view trend graphs of various performance parameters of the PTP signal include master-to-slave and slave-to-master delays and variances.



Stream Timing Application: Use this application to view the timing of the ST 2110 video, audio, and data as it was received relative to the embedded RTP timestamps.

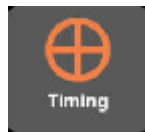

Timing Application: (for IP signals): This adds features to the standard Timing application including to view timing offsets between the incoming ST 2022-6 and ST 2110-20 video signals and PTP signals.

Option MP2-PHY



These additional applications are available when Option PHY is installed (software option MP2-FMT-4K required for 12G support):

Application icons	Description
	Eye Application: Use this application to view an eye pattern diagram of the SDI input only.
	Jitter Application: Use this application to display the wave shape of the jitter and to view additional time-domain information.



Option MP2-GEN

These additional applications are available when option MP2-GEN is installed, unless otherwise noted:

Application icons	Description
	<i>IP Generator Application:</i> Use this application application to provide an IP test signal to check the receiver device and signal path.
	<i>SDI Generator Application:</i> Use this application to provide an SDI test signal to check the receiver device and signal path.

Option MP2-EXTNDSP

This option enables using 8 separate tiles; a second monitor is required. Without this option only 4 tiles can be used and a second monitor duplicates the 4 tiles on the first monitor.





Note: MPX2 models can also be operated with no monitors attached for remote monitoring. If monitors are attached to the MPX2, they must both be the same transport, Display Port or HDMI, not mixed, (through DP1 and DP2 connections with adapters).

View Installed Options

To view options installed on the instrument, select the **Settings** icon () , then select **Utilities**, and then **Options**.

Status Indicators

Many of the application displays include status icons, which provide a quick method for viewing signal status. These icons may appear:

-  Indicates the signal parameter has not been in an error condition.
-  Indicates the signal parameter was in an error condition but the error has now cleared.
-  Indicates the signal parameter is currently in an error condition.
-  Indicates the signal parameter is not being monitored for an error condition.

Waveform Application

The Waveform display is a signal-level-versus-time display of the video signal.

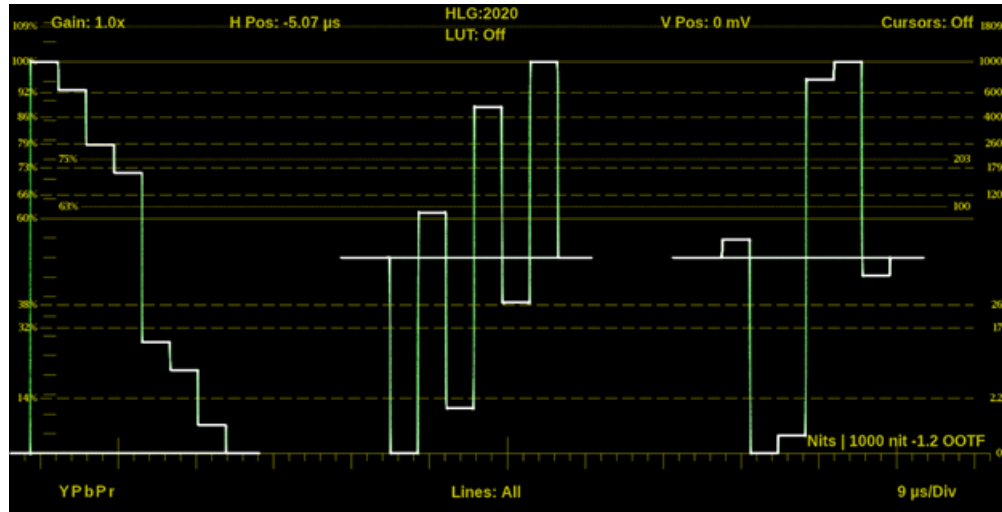

Waveform Settings Menu

Open the Waveform Settings menu:

1. Select the **Tiles** icon ().
2. Select the tile with the Waveform application.

3. Select the **Tile** icon ().

Note: The Move icon () is in the settings menu header. Select this icon to move the settings left or right.

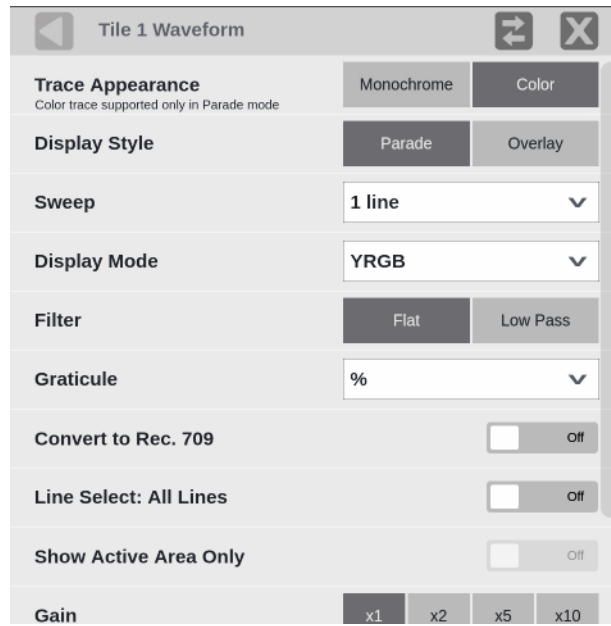

Trace Appearance

To change the colors of the parade traces, select Monochrome or Color.

Monochrome: Displays all traces in a conventional green.

Color: Displays the components of the traces in the colors described in the Display Mode, for example the components in RGB mode are shown in red, green, and blue.

Note: The Color setting only works when Display Style is set to Parade. The Overlay mode displays the traces in green.

Display Style

Select one of the buttons to choose how the signal components are displayed in the active tile:

Parade: All the components are shown one beside the other. This setting allows the traces to appear in the described colors if it is selected in Trace Appearance.

Overlay: All the components are drawn at the same location so they appear one on top of the other. This trace is always displayed in green.

Sweep

Select the Sweep menu and select the waveforms to view between the lines or fields. The available sweep options depend on which display style is active.

- When the Parade display style is active you can select from 1 line or 1 field.
- When Overlay display style is active you can select from 1 line, 2 line, 1 field, or 2 field.

Display Mode

Select the Display Mode menu and select from these choices (only available while displaying SDI inputs):

Note: The inputs are only shown in their colors if Trace Appearance is set to Color.

Y: Displays the input as White (Y) for the Luma component. This display is the YRGB mode with the Red (R), Green (G), and Blue (B) components turned off.

RGB: Displays the input as R, G, and B components.

YPbPr: Displays the input as Y for the Luma component, and color difference Cyan (Pb) and Magenta (Pr) components.

YRGB: Displays the input as Y, R, G, and B components.

Filter

Select one of the buttons to set the waveform filter. This is useful for isolating a specific characteristic of the input. For example, you can enable a Low Pass filter for quick camera exposure setting.

These filters are available:

Flat: Display with the full available bandwidth.

Low Pass: Display only the low frequency part of the signal.

Graticule

Select the Graticule menu and choose a vertical scale value.

Note: The Code Value vertical unit is a hex value. The Stop, Reflectance, and Nits scale are drawn differently depending on the gamma setting in the input menu.

In the Waveform display application, select the **Graticule** menu to choose the graticule that fits your need. The trace represents the video data in the vertical axis.

- The mV, %, and Code Value are fixed graticules. They are compatible with the traditional waveform scales.

- The Reflectance and Stop graticules vary depending on the Gamma selection in the Input Settings menu. These are the Scene light graticules that are used for scene setting and camera exposure adjustment.
- The Nits graticule varies depending on the Gamma selection in Input Settings menu. This is the Display light graticule and is used for mastering the content for a targeted HDR system.

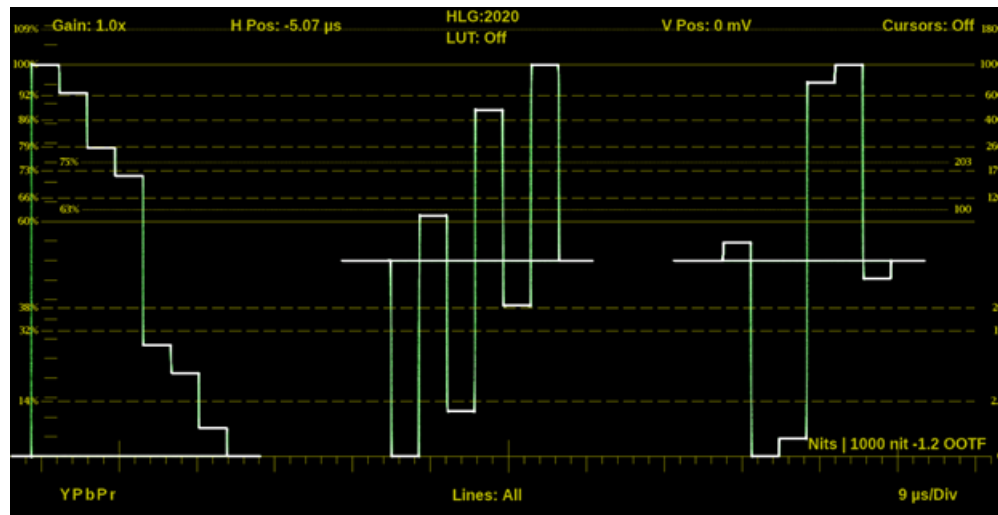

Convert to Rec. 709

Set this control to **On** to allow the trace displays to convert the Gamma and Color Gamut settings for the signal to SDR Narrow and BT. 709 (requires Option MP2-PROD).

Note: Conversion to Rec. 709 automatically converts to BT.709, otherwise the graticule selection must be manually changed. (See [Configure Instrument for HDR/WCG Monitoring](#).) Conversion to Rec. 709 mode is not supported for SD signals.

Line Select

Set this control to On to select 1 Line or Off to select All Lines.

If Line Select is set to **On** (Line Select: Line 1), the display only shows results for the selected line in the picture. The line can be selected using the on-screen tools; see [Line Select Function](#). Or the line can be selected directly on the Picture.

Show Active Area Only

Set this control to On to remove the trace of vertical and horizontal blanking data.

Gain

Select from the options to set to x1, x2, x5, or x10.

Magnification

Select from the options to set magnification to Best, 1.0x, 10.0x, 20.0x, or 25.0x.

Waveform Application On-screen Tools

You can change the gain, horizontal position, vertical position, gamma LUT, cursors, display mode, display format, and selected line, without opening the Waveform Settings menu, through on-screen tools. Select the button for the setting you want to adjust. All the available tools are located on the top and bottom of the display and are highlighted for a few seconds when the application is first opened or if you select in the tile heading.

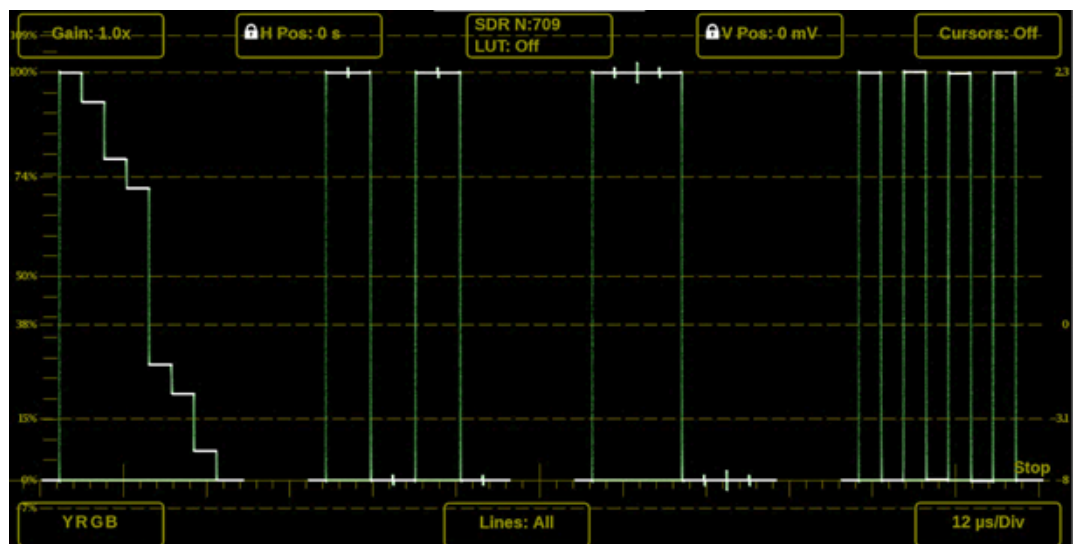

Gain

Increase or decrease the magnification of the trace display.

1. Select **Gain** to open the magnification menu.
2. Select one of the preset magnifications for fixed gain.

3. Select the **Gain** (the number varies) button; select **VAR: Off** to change it to VAR: On. Variable gain allows flexibility in changing the gain factor between 0.5x to 20.0x. The limits of the variable gain change depend on the gain factor you select.
 - 1.0x has a range of 0.25x to 4.00x gain.
 - 2.0x has a range of 0.50x to 8.00x gain.
 - 5.0x has a range of 1.25x to 20.00x gain.
 - 10.0x has a range of 2.50x to 40.00x gain.

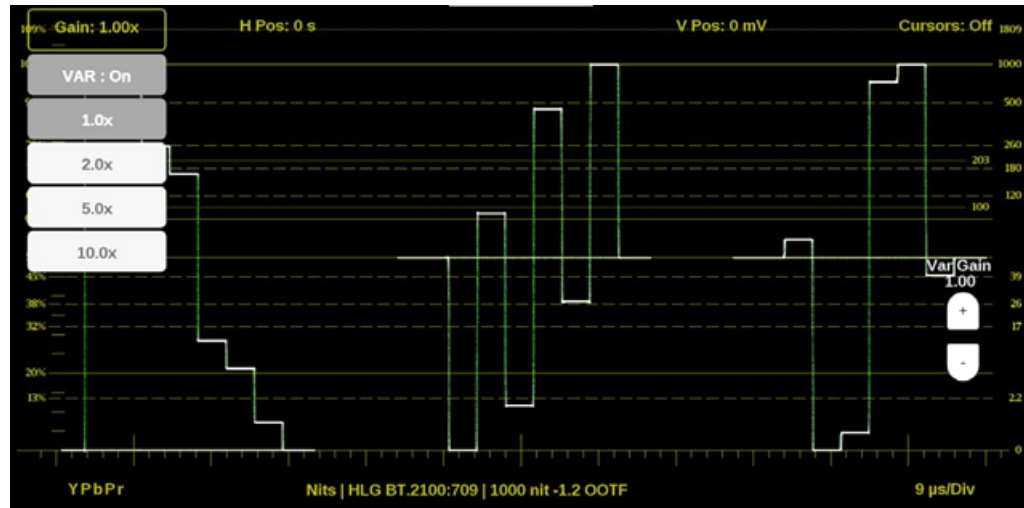

To adjust the gain:

- On a touchscreen, use a pinch gesture to change the scale of the trace for large increments.
- For small increments, select the plus (+) or minus (-) buttons to adjust the gain.
- Use the scroll wheel on a mouse to adjust the variable gain.
- Use the **Reset** icon (🔄) to remove variable gain adjustments.

Horizontal and Vertical Position

Adjust the position of the trace display.

1. Select the **H Pos** button to allow incremental adjustment of the horizontal trace.
 - Select-and-drag to move the trace on the touchscreen. This method can be performed without using the button.
 - Use a mouse scroll wheel to move the trace.

- For incremental adjustments, select the plus (+) or minus (-) buttons to adjust the horizontal position.
- Select the **Reset** icon () to reset the horizontal position adjustment to default.

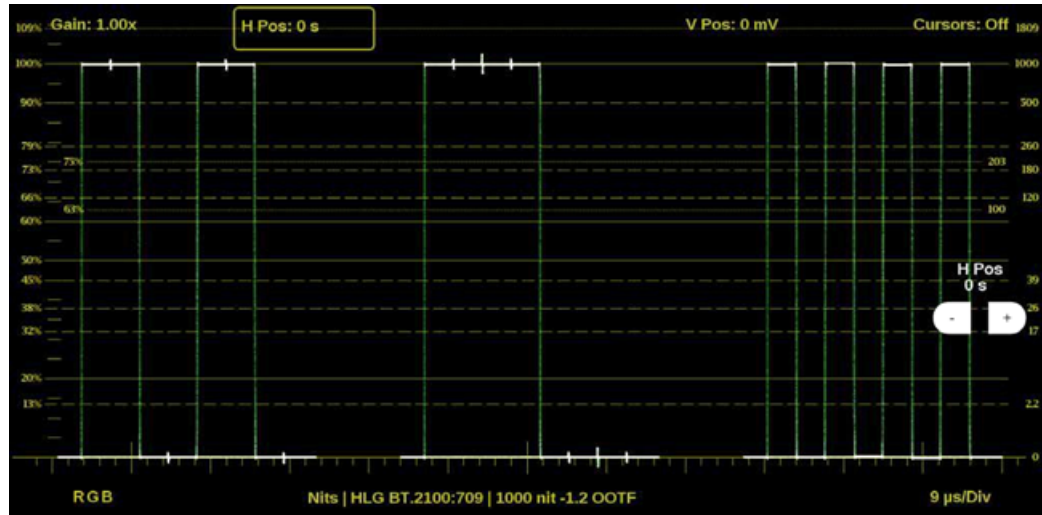

2. Select the **V Pos** button to adjust the vertical trace.

- Select-and-drag to move the trace on the touchscreen. This method can be performed without using the button.
- Use a mouse scroll wheel to move the trace.
- For incremental adjustments, select the plus (+) or minus (-) buttons to adjust the vertical position.
- Use the **Reset** icon () to reset the vertical position adjustment to default.

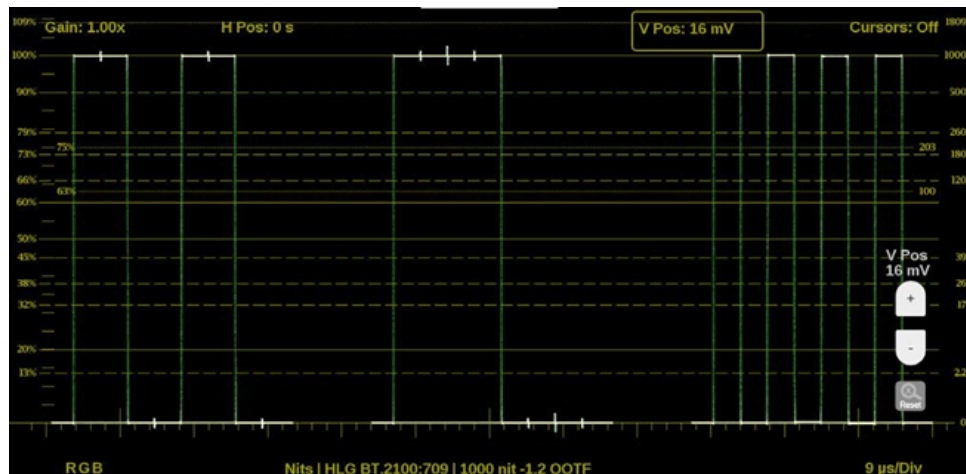

Gamma LUT

Turn the Gamma LUT on or off:

1. Select the **LUT** button (other elements in the button are variable depending on the options selected) in the upper middle of display.
2. Select the lower **LUT:** button to set the Gamma LUT on or off.

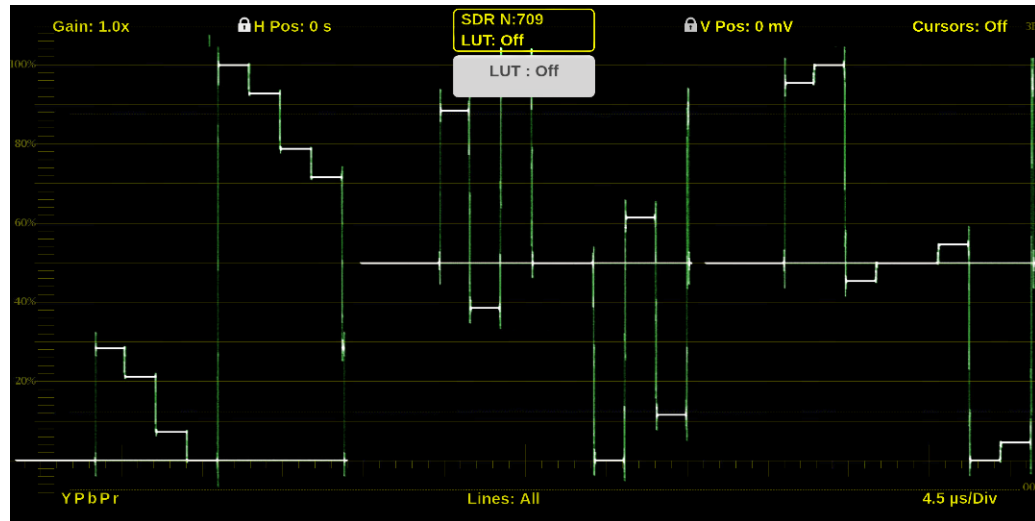

To change the gamma curve and color gamut (displayed in the LUT button):

1. Select the **Settings** icon (⚙️) to open the Settings menu.
2. Select **Inputs** and select the input being used.
3. Select **SDI** and **VIDEO**.
4. Select the Gamma Curve menu and select your option. For details of the options, see [Select the Gamma Curve menu and select the option.](#)
5. Select the Color Gamut menu and select your standard. For details of the standards, see [Choose the Color Gamut option from the menu.](#)
6. Select **Save**.

The LUT button updates to match your selections.

Cursor Measurement

Make precise measurements with time and voltage cursors.

1. Select the **Cursors** button in the top right of the tile to show the time and voltage cursor options.
2. Select the **T: Off** button to display two time cursors. Select **T: On** to hide the two cursors.

3. Select and hold anywhere on the cursors to move them and mark exact times in the trace. The cursors are highlighted in yellow when moved. The timestamp of each cursor and the delta are displayed on the right side of the application.

Note: The cursor tab provides an easy way to adjust each cursor.

4. Select the **V: Off** button to display two voltage cursors. Select **V: On** to hide the two cursors.
5. Select the **V Units** button to change the voltage units between percentage (%), millivolts (mV), or code value (CV). The selected option (% , mc, or CV is added to the button title.
6. Select and hold anywhere on the V1 or V2 cursor and drag the cursor to mark exact times in the trace.

The cursors are highlighted in yellow when moved. The voltage measurement at each cursor and the delta are displayed on the right side of the application.

7. Select the **Cursors** button to hide the T and V buttons.



Note: The time and voltage cursor positions are retained if the trace is moved horizontally or vertically, or if the gain is adjusted.

Display Mode

Change how the waveforms are displayed.

1. Select the button in the bottom left corner of the application to expand the available display options (the button label varies depending on the last option selected).

2. Select one of the waveform display options:
 - Select **YPbPr** to display any combination of the Y, Pb, and Pr components.
 - Select **RGB** to display any combination of the R, G, and B components.
 - Select **YRGB** to display any combination of the Y, R, G, and B components.
3. Select the components to monitor:
 - In the waveform list of components, select the letter of the component to remove it. For example, in RGB select G to remove the green component from the waveform.
 - Select the letter of a removed component to make it visible.

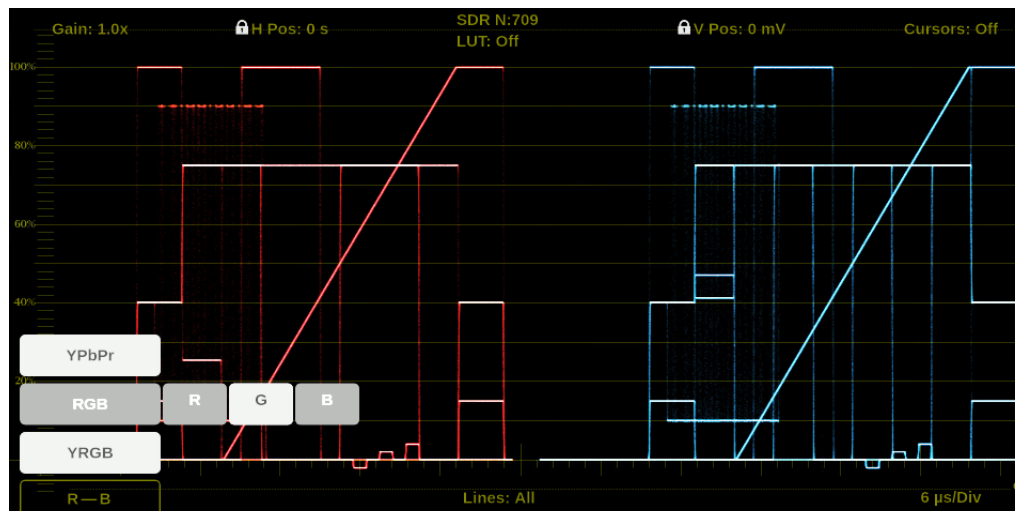

Display Format

Change the Display Style, Sweep, and Magnification of the waveform.

1. Select the button in the bottom right corner of the application to expand the available display format options (the button label varies depending on the last option selected).
2. Select the **Mag** option to set the magnification to Best, 1.0x, 10.0x, 20.0x, or 25.0x.
3. Select the Display Style option to switch between Parade or Overlay.

4. Select the Sweep options as needed. The options available depend on what Display Style is active.
 - When the Parade display style is active you can select from 1 line or 1 field.
 - When Overlay display style is active you can select from 1 line, 2 line, 1 field, or 2 field.

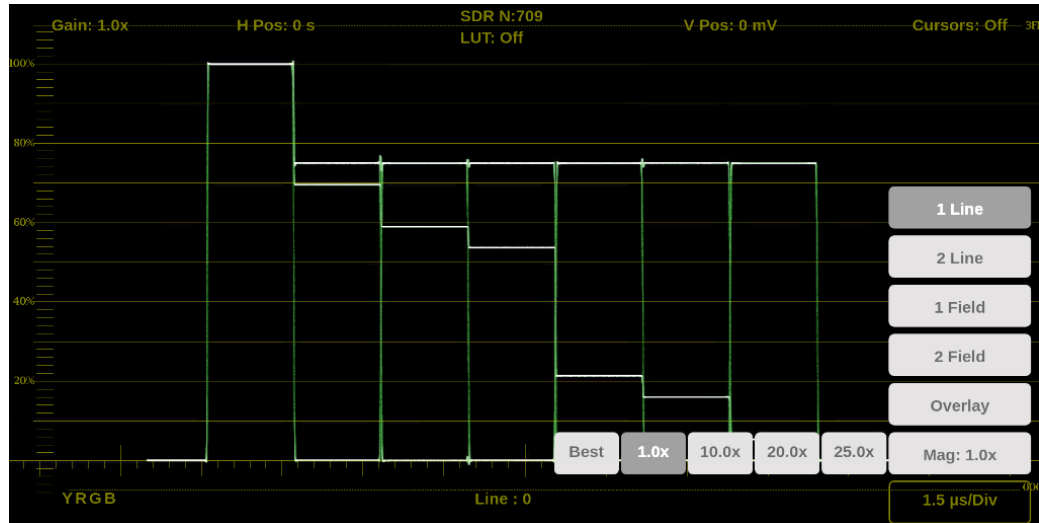

Line Select Function

Line Select allows you to select a single picture line to monitor in the display. By default *All Lines* is selected and all lines are monitored.

Note: The same line is selected in any trace display if Line Select is enabled.

To turn on Line Select (and choose the line to monitor):

1. Select the **Lines** button at the bottom of the tile.
2. Select **1 Line**.
 - To scroll through lines, select the plus (+) or minus (-) buttons.
 - To enter a specific line to monitor:
 - ◆ select **Line Sel.** and enter the line on the keypad,
 - or
 - ◆ in the Picture application, use the line-select cursor (for active lines).

Depending on the resolution in the signal, the Line Select provides different information.

- If a signal is SD, HD, 3G:
 - ◆ the *Line* number is the selected line, including vertical blanking,
 - ◆ if the signal is interlaced format, the *Fields* readout is below the Line number,
 - ◆ the *Pic Line* number is next to Line; the Pic Line is the active line number, or numbers, selected.



- If a signal is UHD, 4K:
 - ◆ the *Line* number is the selected raster line,
 - ◆ the *SDI Line* is the selected line including vertical blanking,
 - ◆ the *link* number appears below the SDI Line.

Note: In link, the letters (A, B, C, or D) refers to the physical links. The numbers (1, 2, 3, or 4) refers to the virtual links. For example, A3/62 indicates it is physical link 1 and virtual link 3 (in a 2-sample interleave, 12G transport).

Vector Application

The Vector application provides an X-Y plot of color difference signals allowing the operator to match skin tones and color of ITU-R BT 709 or 2020 color space. With Option MP2-PROD, transfer function/color space conversion allows for an ITU-R BT 709 color space to verify wide color-gamut compatibility.

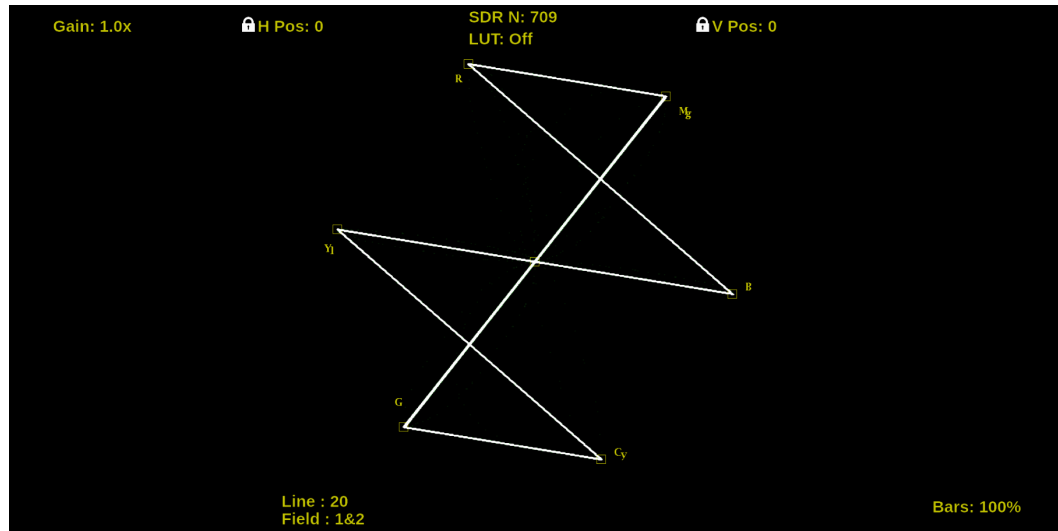

Vector Settings Menu

Open the Vector Settings menu:

1. Select the **Tiles** icon (🧩).
2. Select the tile with the Vector application.
3. Select the **Tile** icon (⚙️).

Note: The Move icon (↔️) is in the settings menu header. Select this icon to move the settings left or right.



Bar Targets

Select between 75% or 100% scaling.

IQ Axis

Select this to turn the IQ Axis On or Off.

Note: This is only for inputs configured for Rec. 709 Color Gamuts.

Gain

Select one of the trace vector magnifications: 1.0x, 2.0x, 5.0x, or 10.0x.

Convert to Rec. 709

Turn this setting On to allow the trace displays to convert the Gamma and Color Gamut settings for the signal to SDR Narrow and BT. 709 (requires Option MP2-PROD).

Note: Set Convert to Rec. 709 to On to automatically convert settings to BT.709; if it is not set, the graticule selection must be manually changed. (See [Configure Instrument for HDR/WCG Monitoring](#).) Convert to Rec. 709 mode is not supported for SD signals.

Line Select

Line Select allows you to choose the picture lines to monitor in the display. Either All Lines or 1 Line can be selected.

If 1 Line is selected then the display only shows results for the selected line in the picture. The line can be selected using the on-screen tools; see [Line Select Function](#). Or the line can be selected directly on the Picture.

Vector Application On-screen Tools

You can change the gain, horizontal position, vertical position, gamma LUT, selected line, and bar targets without opening the Vector settings menu through on-screen tools. Select the button for the setting you want to adjust. All the available tools are located on the top and bottom of the display and are highlighted for a few seconds when the application is first opened or if you select anywhere in the middle of the application tile.

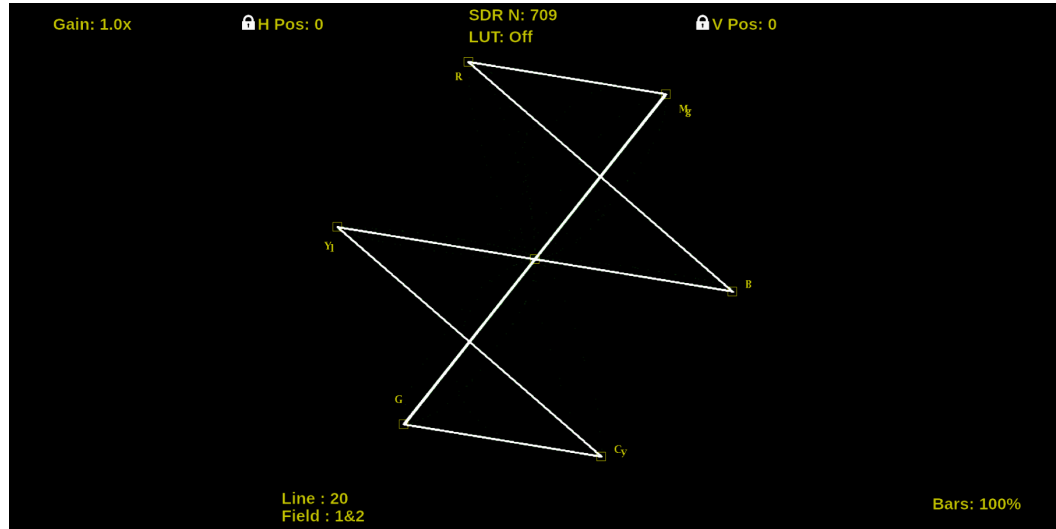

Gain

Increase or decrease the magnification of the trace display.

1. Select **Gain** (the number varies) in the trace tile to open the magnification menu.
2. Select one of the preset magnifications for fixed gain.

On a touchscreen, you can use a pinch gesture to change the scale of the trace for large increments.

3. Select **VAR:** (On or Off) to turn the variable gain on or off.

Variable gain (VAR: On) allows you to change the gain factor (Var Gain) in 0.01 increments.

4. Select the + (plus) or - (minus) buttons under Var Gain as needed to make detailed adjustments to the variable gain.

The limits of the variable gain change depending on the gain factor you select.

- 1.0x has a range of 0.25x to 4.00x gain.
- 2.0x has a range of 0.50x to 8.00x gain.
- 5.0x has a range of 1.25x to 20.00x gain.
- 10.0x has a range of 2.50x to 40.00x gain.

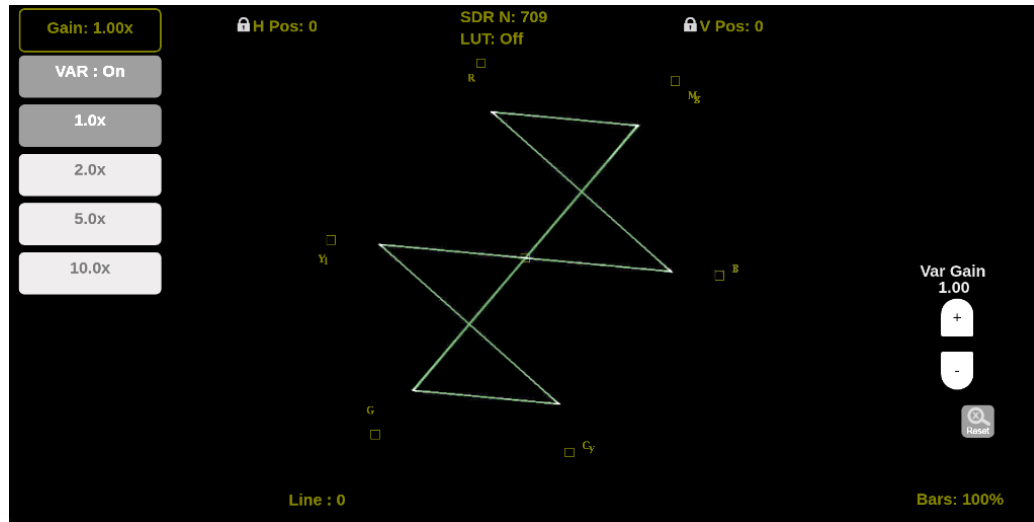

Select the **Reset** icon () to remove variable gain adjustments and reset the gain to 1.00 and 1.0x.

Horizontal and Vertical Position

Adjust the position of the trace display.

1. Select **H Pos** to allow adjustment of the horizontal trace.
 - Select-and-drag to move the trace on the touchscreen. This method can be performed without using the button.
 - Use a mouse scroll wheel to move the trace.
 - For small changes, select the + (plus) or - (minus) buttons to adjust the horizontal position.
 - Select the **Reset** icon () to reset the horizontal position adjustment to default.

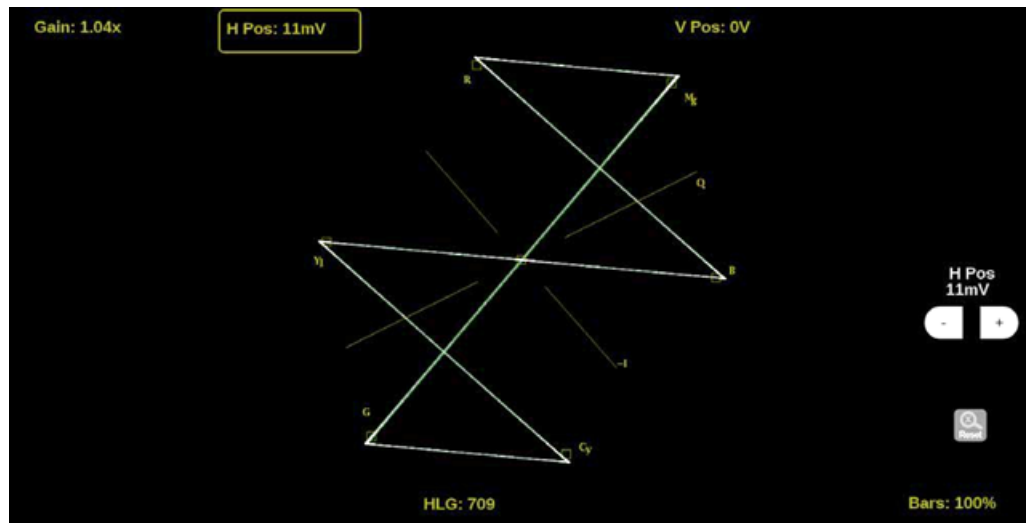

2. Select V Pos to allow adjustment of the vertical trace.

- Select-and-drag to move the trace on the touchscreen. This method can be performed without using the button.
- Use a mouse scroll wheel to move the trace.
- For small changes, select the + (plus) or - (minus) buttons to adjust the horizontal position.
- Select the Reset icon (🔄) to reset the vertical position adjustment to default.

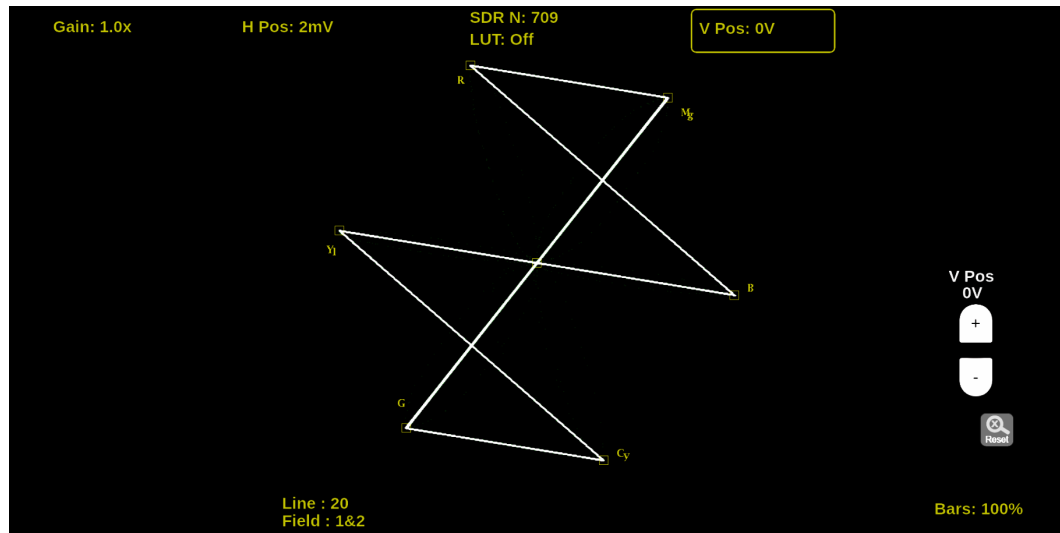

Gamma LUT

Turn the Gamma LUT on or off:

1. Select the **LUT** button (other elements in the button are variable depending on the options selected) in the upper middle of the display.
2. Select the lower **LUT:** button to set the Gamma LUT on or off.

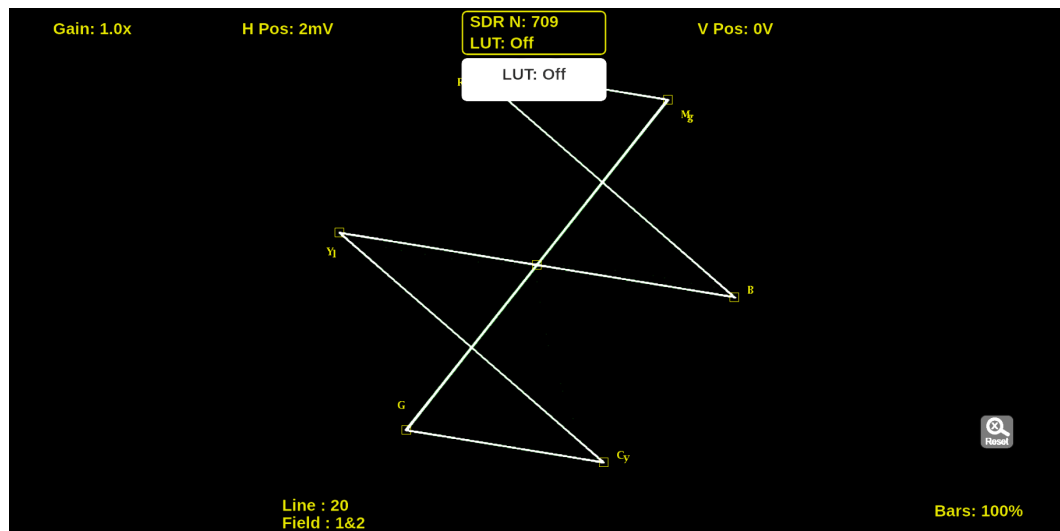

To change the gamma curve and color gamut (displayed in the LUT button):

1. Select the **Settings** icon () to open the Settings menu.
2. Select **Inputs** and select the input being used.
3. Select **SDI** and **VIDEO**.
4. Select the Gamma Curve menu and select your option. For details of the options, see [Select the Gamma Curve menu and select the option.](#)
5. Select the Color Gamut menu and select your standard. For details of the standards, see [Choose the Color Gamut option from the menu.](#)
6. Select **Save**.

The LUT button updates to match your selections.

Bar Targets

Change the scaling of the Vector display.

1. Select the Bars button in the bottom right corner of the application to expand the available options.
2. Select either 75% or 100% scaling.

Line Select Function

Line Select allows you to select a single picture line to monitor in the display. By default *All Lines* is selected and all lines are monitored.

Note: The same line is selected in any trace display if line select is enabled.

To turn on Line Select (and choose the line to monitor):

1. Select the Lines button at the bottom of the tile.
2. Select 1 Line.
 - To scroll through lines, select the + (plus) or - (minus) buttons.
 - To enter a specific line to monitor:
 - ◆ select **Line Sel.** and enter the line on the keypad,
 - or
 - ◆ in the Picture application, use the line-select cursor (for active lines).

Depending on the resolution in the signal, the Line Select provides different information.

- If a signal is SD, HD, 3G:
 - ◆ the *Line* number is the selected line, including vertical blanking,
 - ◆ if the signal is interlaced format, the *Fields* readout is below the Line number,
 - ◆ the *Pic Line* number is next to Line; the Pic Line is the active line number, or numbers, selected.

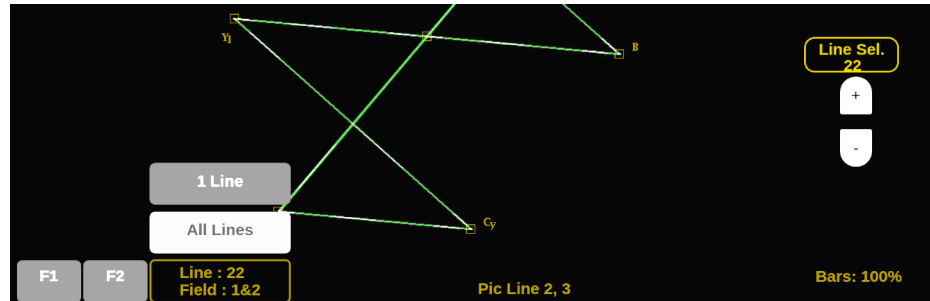

- If a signal is UHD, 4K:
 - ◆ the *Line* number is the selected raster line,
 - ◆ the *SDI Line* is the selected line including vertical blanking,
 - ◆ the link number appears below the SDI Line.

Note: In link, the letters (A-D) refers to the physical links. The numbers (1-4) refers to the virtual links. For example, A3/62 indicates it is physical link 1 and virtual link 3 (in a 2-sample interleave, 12G transport).

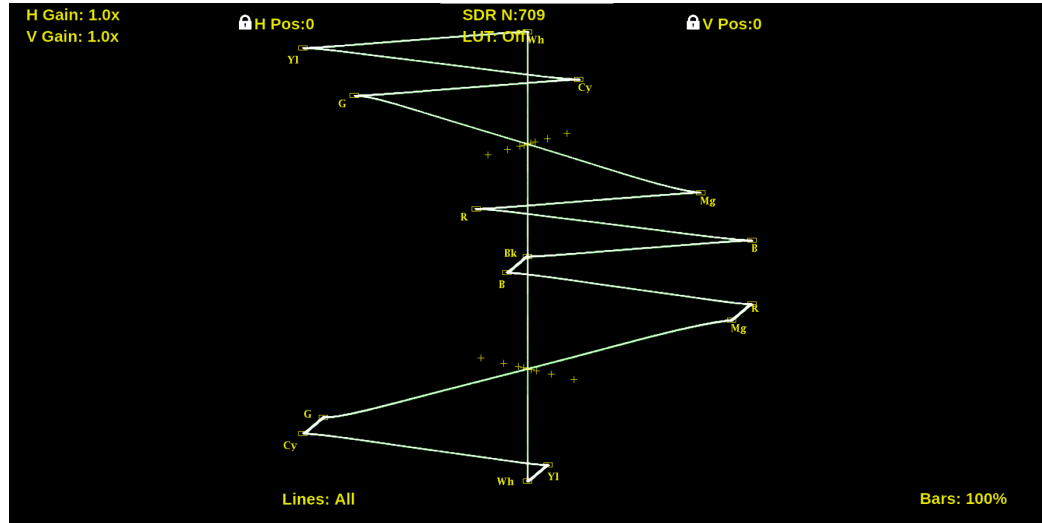

Lightning Application

The Lightning application shows luma and chroma amplitudes and helps verify component timing using a color-bar signal. Using a test signal in component format, this display helps make precise, accurate measurements of inter-channel amplitude and timing.



Lightning Settings Menu

Open the Lightning Settings menu:

1. Select the **Tiles** icon ().
2. Select the tile with the Lightning application.
3. Select the **Tile** icon ().

Note: The Move icon () is in the settings menu header. Select this icon to move the settings left or right.



Bar Targets

Change the bar targets to either 75% or 100%.

V Gain

Change the vertical gain by 1.0x, 2.0x, 5.0x, or 10.0x magnification.

H Gain

Change the horizontal gain by 1.0x, 2.0x, 5.0x, or 10.0x magnification.

Convert to Rec. 709

Set to **On** to allow the trace displays to convert the Gamma and Color Gamut settings for the signal to SDR Narrow and BT. 709 (requires Option MP2-PROD).

Note: Convert to Rec. 709 auto converts to BT.709, otherwise the graticule selection must be manually changed. For details see [Configure Instrument for HDR/WCG Monitoring](#). Convert to Rec. 709 mode is not supported for SD signals.

Line Select

Line Select allows you to choose the picture lines to monitor in the display. Either All Lines or 1 Line can be selected.

If 1 Line is selected, the display only shows results for the selected line in the picture. The line can be selected using the on-screen tools; see [Line Select Function](#). Or the line can be selected directly on the Picture.

Lightning Application On-screen Tools

You can change the horizontal gain, vertical gain, horizontal position, vertical position, gamma LUT, selected line, and bar targets without opening the Lightning Settings menu through on-screen tools. Select the button for the setting you want to adjust. All the available tools are located on the top and bottom of the display and are highlighted for a few seconds when the application is first opened or if you select anywhere in the middle of the application tile.

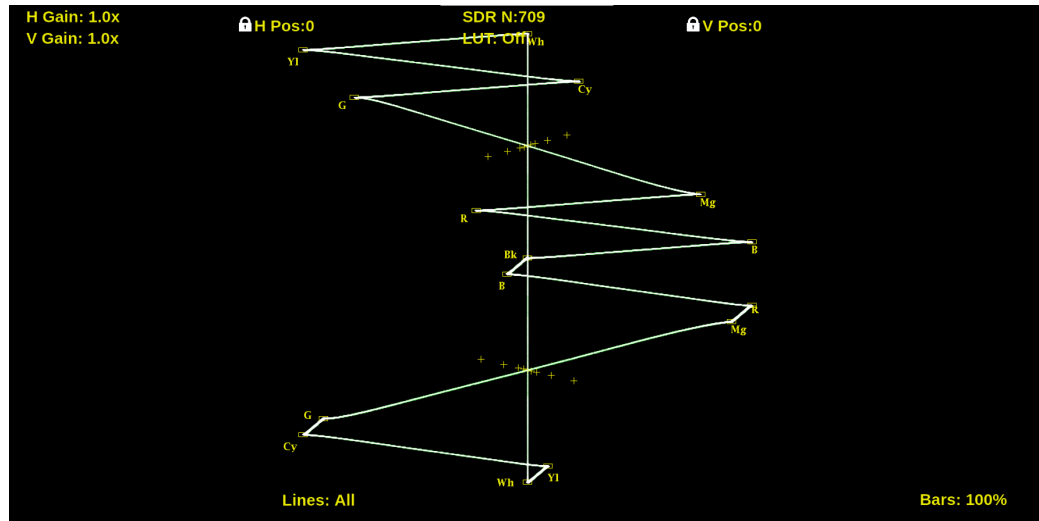

Horizontal and Vertical Gain

Increase or decrease the magnification of the horizontal and vertical trace displays.

1. Select the button at the top-left to open the available options menu.
2. Select one of the preset magnifications for fixed horizontal and vertical gain using the H Gain and V Gain options.

3. Select Variable Gain; select VAR: Off to VAR: H or VAR: V.

- Select **VAR: H** to change the horizontal gain in increments.
- Select **VAR: V** to change the vertical gain. Variable gain allows you flexibility in changing the gain factor between 0.5x to 20.0x.
- Select **Off** to shut off both gain options.

The limits of the variable gain change depending on the gain factor you select.

- ◆ 1.0x has a range of 0.25x to 2.00x gain.
- ◆ 2.0x has a range of 0.50x to 4.00x gain.
- ◆ 5.0x has a range of 1.25x to 10.00x gain.
- ◆ 10.0x has a range of 2.50x to 20.00x gain

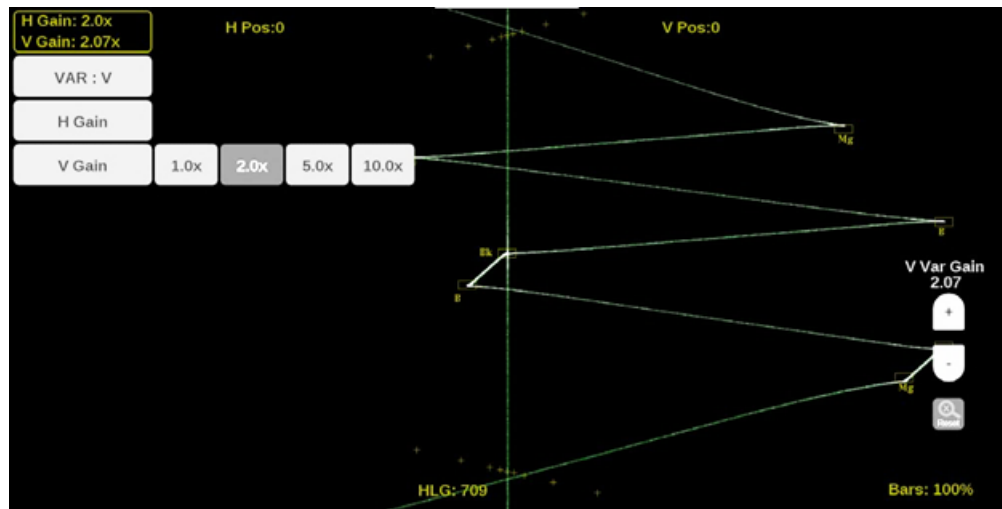
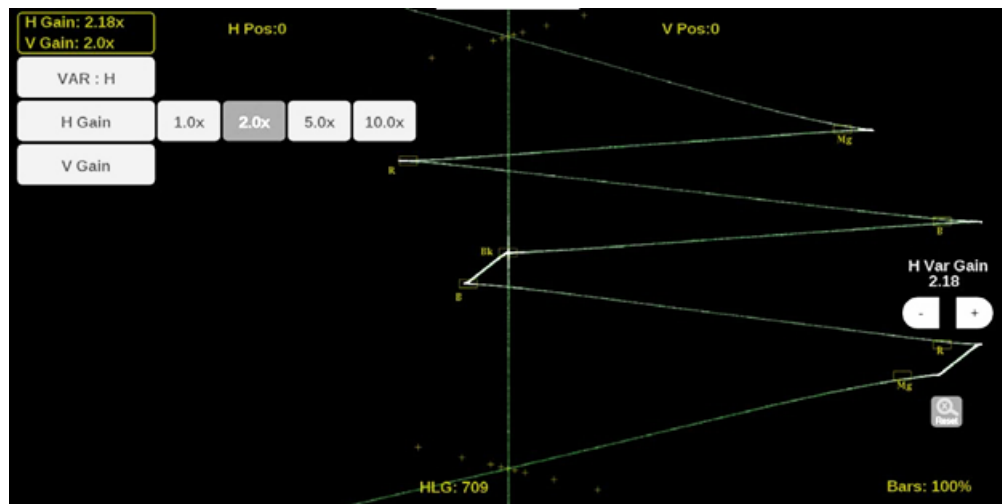

To adjust the gain:

- With a touchscreen, use a pinch gesture to change the scale of the trace for large incremental changes.
- For incremental adjustments, select the + (plus) or - (minus) buttons.
- Use the scroll wheel on a mouse to adjust the variable gain.
- Select the **Reset** icon () to remove variable gain adjustments.

Horizontal and Vertical Position

Adjust the position of the trace display:

1. Select the **H Pos** button to allow adjustment of the horizontal trace.
 - Select-and-drag to move the trace on the touchscreen. This method can be performed without using the button.
 - Use a mouse scroll wheel to move the trace.
 - For incremental adjustments, select the + (plus) or - (minus) button.
 - Select the **Reset** icon () to change the horizontal position adjustment to default.

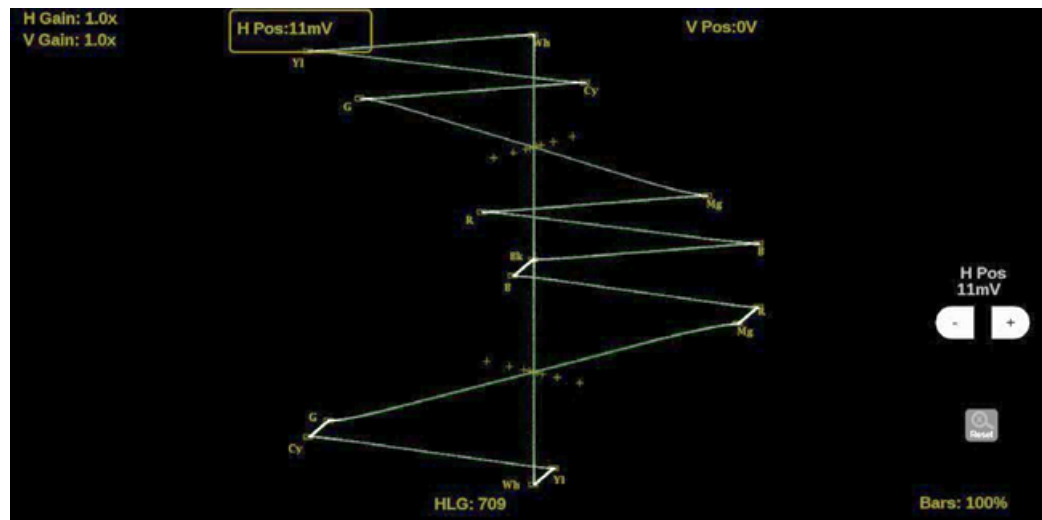

2. Select the **V Pos** button to allow adjustment of the vertical trace.
 - Select-and-drag to move the trace on the touchscreen. This method can be performed without using the button.
 - Use a mouse scroll wheel to move the trace.
 - For incremental adjustments, use the + (plus) or - (minus) button.
 - Select the **Reset** icon () to reset the vertical position adjustment to default.

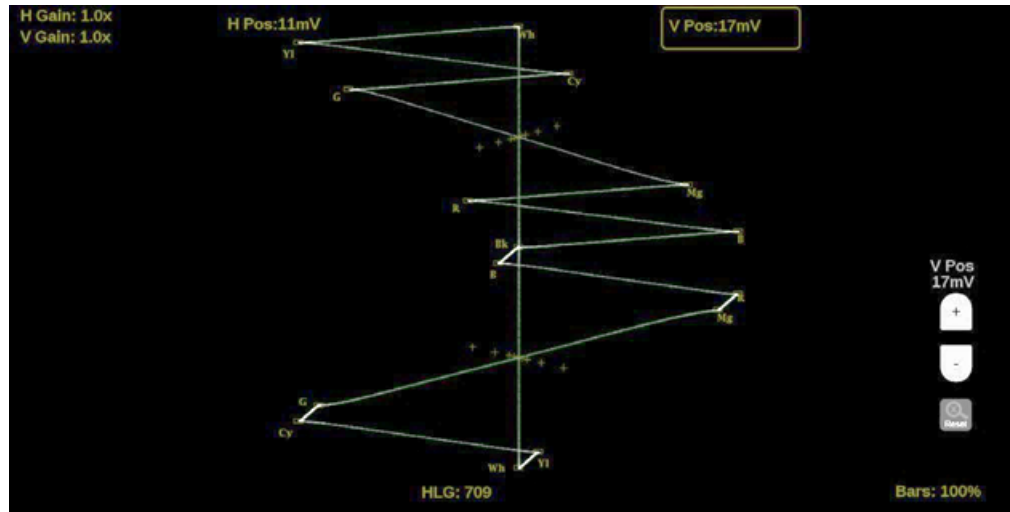

Gamma LUT

Turn the Gamma LUT on or off:

1. Select the **LUT** button (other elements in the button are variable depending on the options selected) in the upper middle of the tile.
2. Select the lower **LUT**: button to set the Gamma LUT on or off.

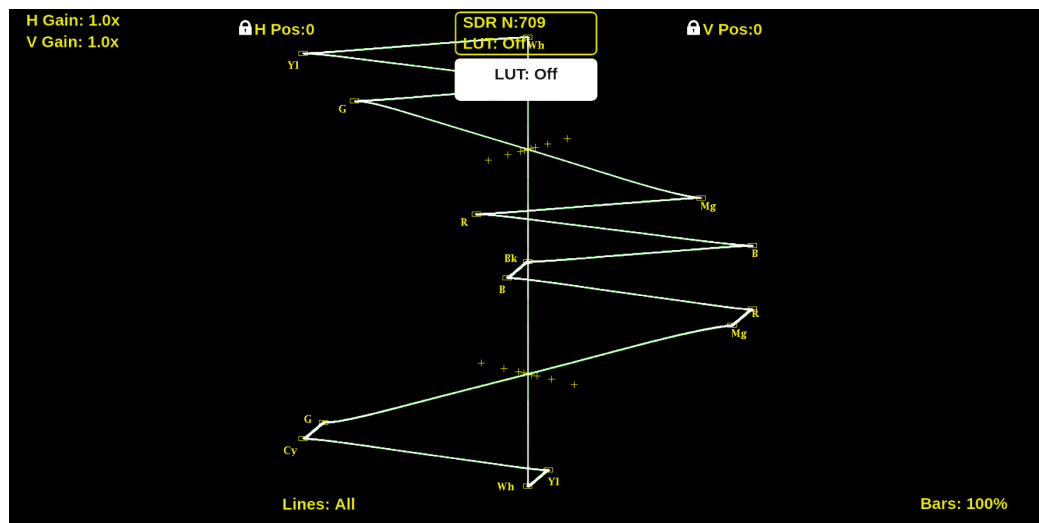

To change the gamma curve and color gamut (displayed in the LUT button):

1. Select the **Settings** icon () to open the Settings menu.
2. Select **Inputs** and select the input being used.
3. Select **SDI** and then select **VIDEO**.
4. Select the Gamma Curve menu and select your option. For details of the options, see [Select the Gamma Curve menu and select the option](#).
5. Select the Color Gamut menu and select your standard. For details of the standards, see [Choose the Color Gamut option from the menu](#).
6. Select **Save**.
The LUT button updates to match your selections.

Bar Targets

Change the scaling of the Lightning Display.

1. Select **Bars** in the bottom-right corner of the application to expand the available options.
2. Select 75% or 100% scaling.

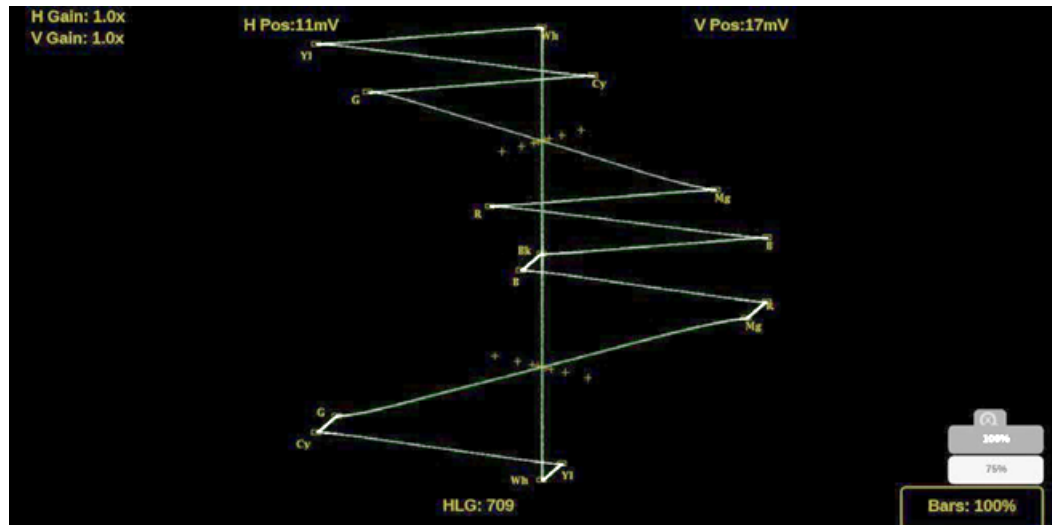

Line Select Function

Line Select allows you to select a single picture line to monitor in the display. By default *All Lines* is selected and all lines are monitored.

Note: The same line is selected in any trace display if line select is enabled.

To turn on Line Select (and choose the line to monitor):

1. Select the **Lines** button at the bottom of the tile.

2. Select 1 Line.

- To scroll through lines, use the plus (+) or minus (-) button.
- To enter a specific line to monitor:
 - ◆ select **Line Sel.** and enter the line on the keypad
 - or
 - ◆ in the Picture application, use the line-select cursor (for active lines).

Depending on the resolution in the signal, the Line Select provides different information.

- If a signal is SD, HD, or 3G:
 - ◆ the *Line* number is the selected line, including vertical blanking,
 - ◆ if the signal is interlaced format, the *Fields* readout is below the Line number,
 - ◆ the *Pic Line* number is next to Line; the Pic Line is the active line number, or numbers, selected.

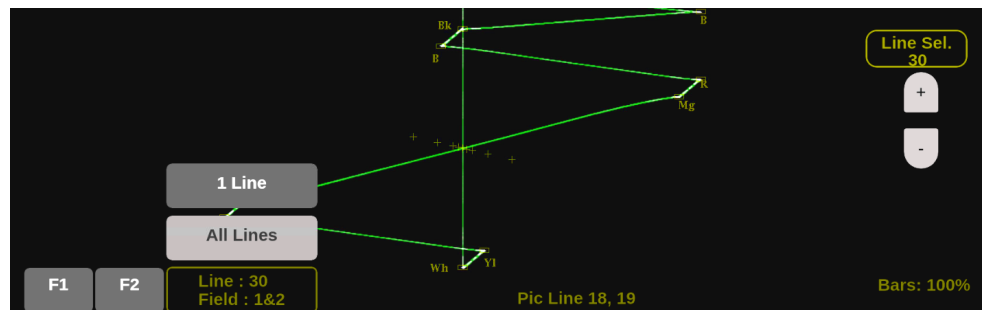

- If a signal is UHD or 4K:
 - ◆ the *Line* number is the selected raster line,
 - ◆ the *SDI Line* is the selected line including vertical blanking,
 - ◆ the *link* number appears below the SDI Line.

In link, the letters (A-D) refers to the physical links. The numbers (1-4) refers to the virtual links. For example, A3/62 indicates it is physical link 1 and virtual link 3 (in a 2-sample interleave, 12G transport).

Diamond Application

The Diamond application provides a tool for white and black balancing at camera setup and for color gamut adjustment at color editing and QC. For additional information on how to use the Diamond application, refer to the [Checking Gamut](#) section.

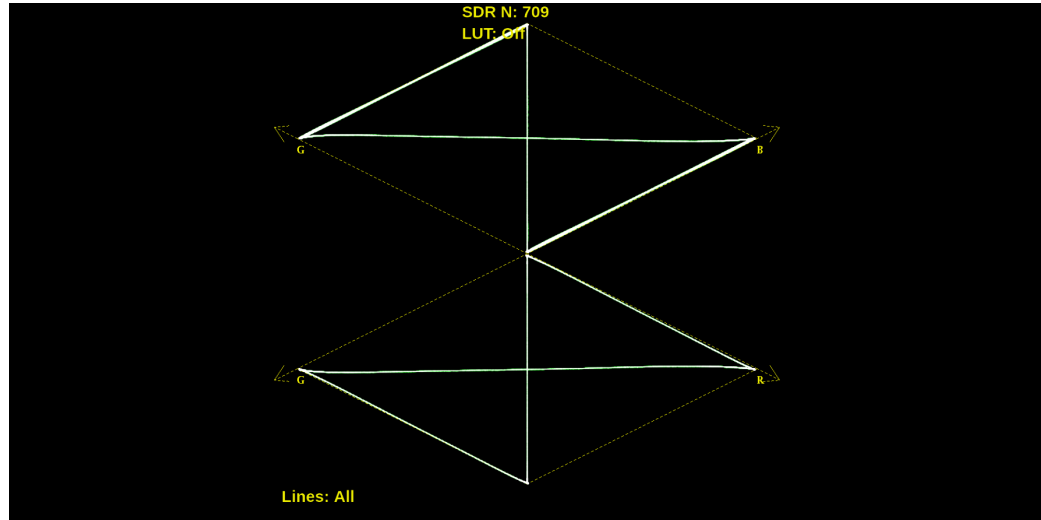

Diamond Settings Menu

Open the Diamond Settings menu:

1. Select the **Tiles** icon (🧩).
2. Select the tile with the Diamond application.
3. Select the **Tile** icon (⚙️).

Note: The Move icon (↔️) is in the settings menu header. Select this icon to move the settings left or right.

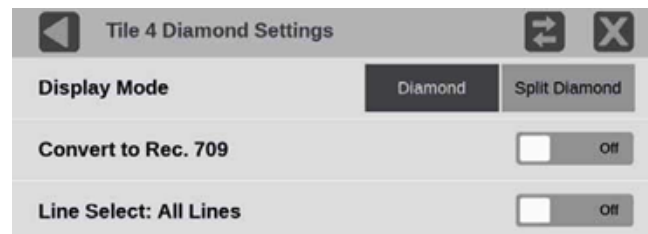

Display Mode

Select one of the options:

Diamond: The normal Diamond display shows Gamut violations of the SDI input if translated to RGB color space.

Split Diamond: The split Diamond display offsets the two halves of the Diamond to better see negative RGB Gamut errors.

Convert to Rec. 709

Set to **On** to allow the trace displays to convert the Gamma and Color Gamut settings for the signal to SDR Narrow and BT. 709 (requires Option MP2-PROD).

Note: Convert to Rec. 709 auto converts to BT.709, otherwise the graticule selection must be manually changed (see [Configure Instrument for HDR/WCG Monitoring](#)). Convert to Rec. 709 mode is not supported for SD signals.

Line Select

Line Select allows you to choose the picture lines to monitor in the display. Either All Lines or 1 Line can be selected.

If 1 Line is selected, the display only shows results for the selected line in the picture. The line can be selected using the on-screen tools; see [Line Select Function](#). Or the line can be selected directly on the Picture.

Checking Gamut

The diamond display effectively shows how the R, G, and B signals relate. The Diamond display is a good tool for detecting gamut errors.

To form the diamond display, the instrument converts the Y, Pb, and Pr components recovered from the serial signal to R, G, and B. To predictably display all three components, they must lie between peak white, 700 mV, and black, 0 V.

For a signal to be in gamut, all signal vectors must lie within the G-B and G-R diamonds. Conversely, if a signal vector extends outside the diamond, it is out of gamut. The direction of an excursion out of gamut indicates which signal is excessive. Errors in

green amplitude affect both diamonds equally, while blue amplitude errors affect only the top diamond and red errors affect only the bottom diamond.

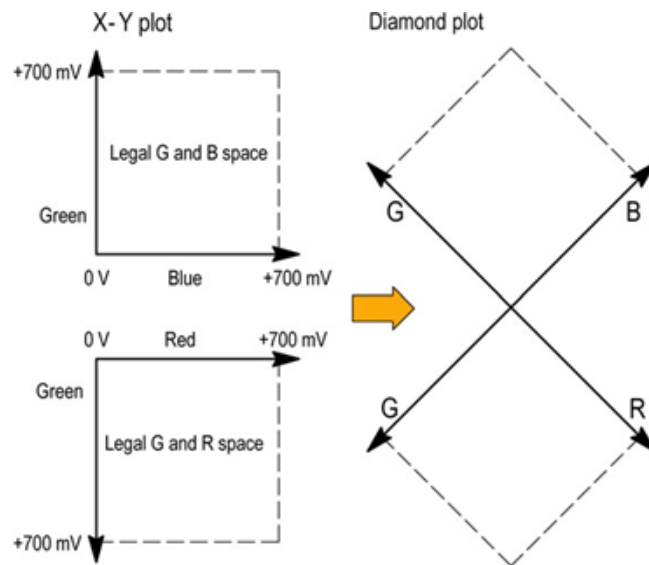

Compare the signal to the display to determine out-of-gamut components. Be aware of these details:

- The intensity of a vector indicates its duration.
- A momentary out-of-gamut condition appears as a faint trace. Long duration violations show as a bright trace.

When evaluating out-of-gamut components, consider:

- Example A:
 - R - Ok
 - $G > 700 \text{ mV}$
 - B - Ok
- Example B:
 - R - Ok
 - G - Ok
 - $B > 700 \text{ mV}$

- Example C:
R - Ok
G - Ok, 350 mV
B < 0 mV

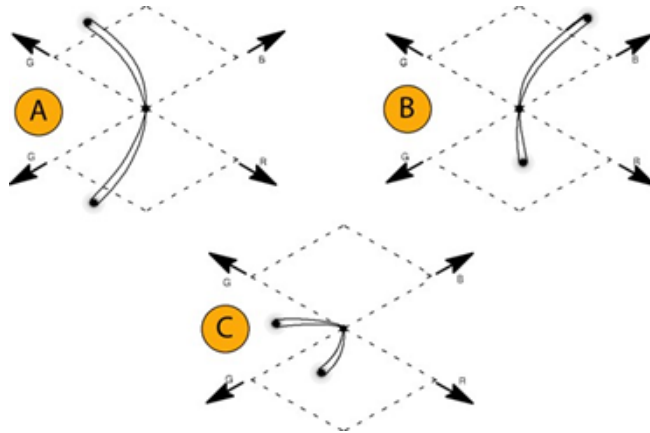

Note: Bending of the transitions indicates timing delays. When a color bar signal is applied, the vertical axis becomes an indicator of delay errors. Monochrome signals appear as vertical lines. Nonlinear component processing, such as from a gamma corrector that alters white balance, can cause deviations along the vertical axis.

Diamond Application On-screen Tools

You can change the gamma LUT and selected line—without opening the Diamond Settings menu—through on-screen tools. Select the button for the setting you want to adjust. All the available tools are located on the top and bottom of the display and are

highlighted for a few seconds when the application is first opened or if you select anywhere in the middle of the application tile.

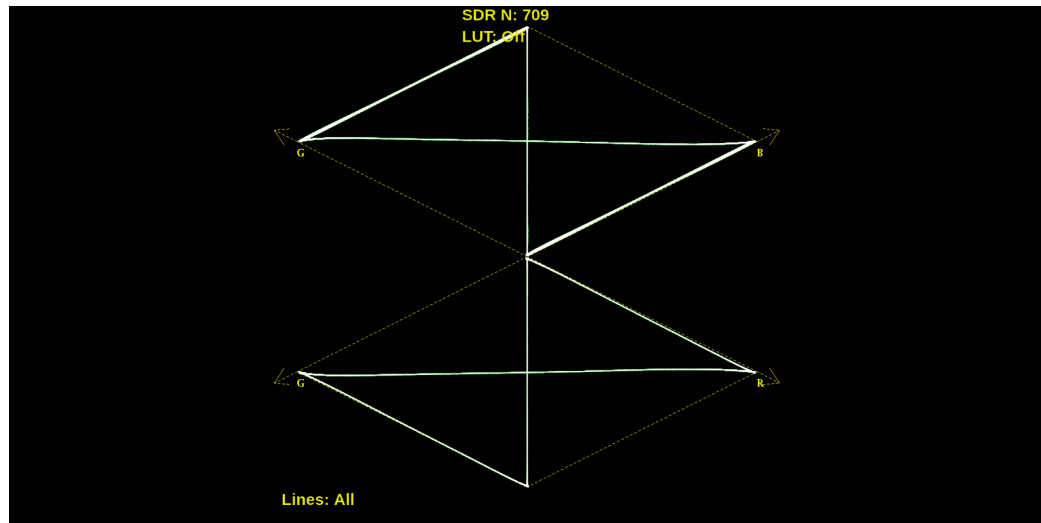

Gamma LUT

Turn the Gamma LUT on or off:

1. Select the **LUT** button (other elements in the button are variable depending on the options selected) in the upper middle of the tile.
2. Select the lower **LUT:** button to set the Gamma LUT on or off.

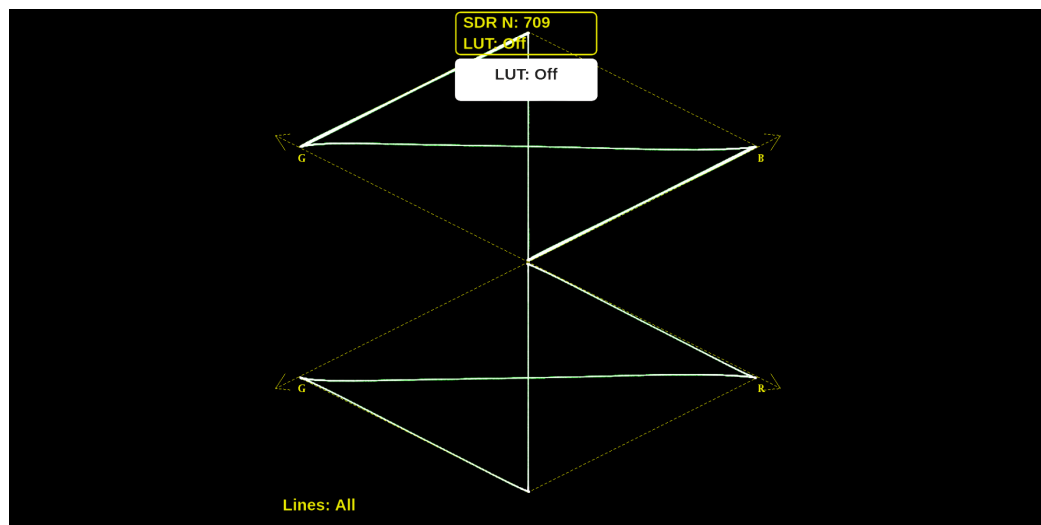

To change the gamma curve and color gamut (displayed in the LUT button):

1. Select the **Settings** icon () to open the Settings menu.
2. Select **Inputs** and select the input being used.
3. Select **SDI** and **VIDEO**.

4. Select the Gamma Curve menu and select your option. For details of the options, see [Select the Gamma Curve menu and select the option.](#)
5. Select the Color Gamut menu and select your standard. For details of the standards, see [Choose the Color Gamut option from the menu.](#)
6. Select **Save**.

The LUT button updates to match your selections.

Line Select Function

Line Select allows you to select a single picture line to monitor in the display. By default All Lines is selected and all lines are monitored.

Note: The same line is selected in any trace display if line select is enabled.

To turn on Line Select (and choose the line to monitor):

1. Select the **Lines** button at the bottom of the tile.
2. Select **1 Line**.
 - To scroll through lines, select the plus (+) or minus (-) buttons.
 - To enter a specific line to monitor:
 - ◆ select **Line Sel.** and enter the line on the keypad,
 - or
 - ◆ in the Picture application, use the line-select cursor (for active lines).

Depending on the resolution in the signal, the Line Select provides different information.

- If a signal is SD, HD, or 3G:
 - ◆ the *Line* number is the selected line, including vertical blanking;
 - ◆ if the signal is interlaced format, the *Fields* readout is below the Line number;
 - ◆ the *Pic Line* number is next to Line; the Pic Line is the active line number, or numbers, selected.

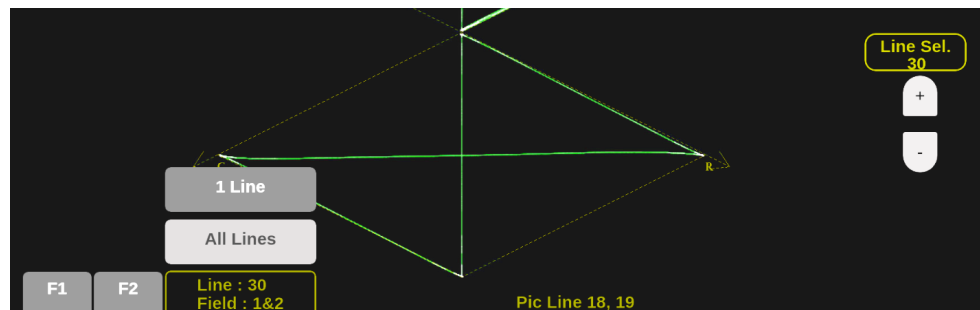

- If a signal is UHD or 4K:
 - ◆ the *Line* number is the selected raster line,
 - ◆ the *SDI Line* is the selected line including vertical blanking,
 - ◆ the *link* number appears below the SDI Line.

Note: In link, the letters (A-D) refers to the physical links. The numbers (1-4) refers to the virtual links. For example, A3/62 indicates it is physical link 1 and virtual link 3 (in a 2-sample interleave, 12G transport).

CIE Application

The CIE application shows video data as it is plotted in a 1931 or 1976 CIE diagram. CIE diagrams are used to check the chromaticity of the video signal and determine compliance to the standard color Gamut limits shown on the CIE diagram. In addition to the BT.2020, P3, and Rec. 709 limits shown, the D65 white point is also indicated.

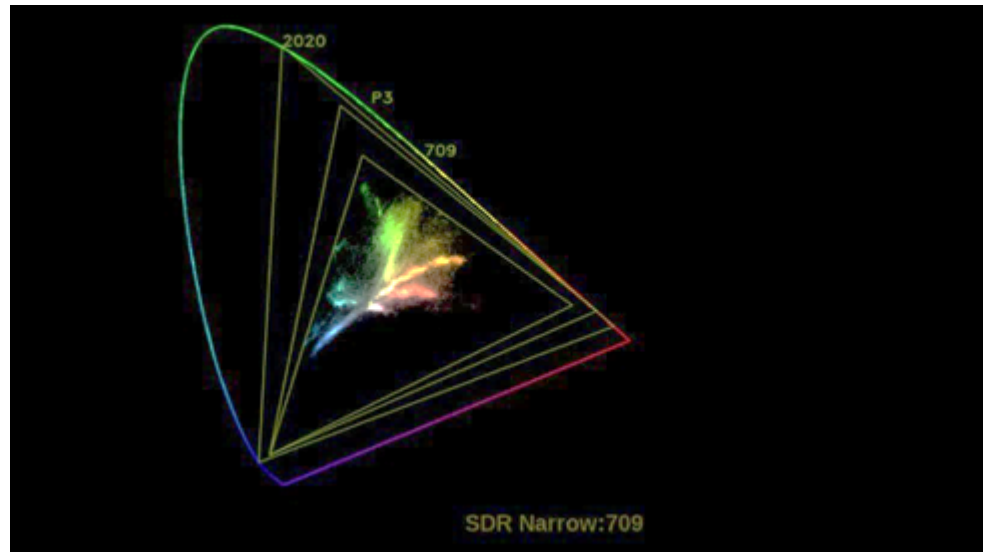

CIE Settings Menu

Open the CIE Settings menu:

1. Select the **Tiles** icon (🧩).
2. Select the tile with the CIE application.
3. Select the **Tile** icon (⚙️).

Note: The Move icon (↔️) is in the settings menu header. Select this icon to move the settings left or right.

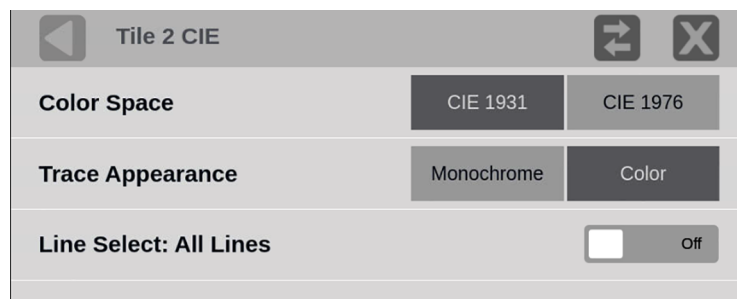

Color Space

Select either CIE 1931 or CIE 1976.

Trace Appearance

You can plot the video data on the CIE display in either Monochrome or Color. If Color is selected, the plotted video data is colored with the corresponding CIE diagram colors. If Color is not selected, the plotted video data is gray.

Line Select

Line Select allows you to choose the picture lines to monitor in the display. Either All Lines or 1 Line can be selected.

Set the control to **On** to select 1 Line to monitor. If 1 Line is selected then the display only shows results for the selected line. The line can be selected using the on-screen tools; see [Line Select Function](#).

Set the control to **Off** to monitor all lines.

CIE Application Line Select Function

Line Select allows you to select a single picture line to monitor in the display. By default *All Lines* is selected and all lines are monitored.

Note: The same line is selected in any trace display if line select is enabled.

To turn on Line Select (and choose the line to monitor):

1. Select the **Lines** button at the bottom of the tile.
2. Select **1 Line**.
 - To scroll through lines, use the plus (+) or minus (-) button.
 - To enter a specific line to monitor:
 - ◆ select **Line Sel.** and enter the line on the keypad
 - or
 - ◆ in the Picture application, use the line-select cursor (for active lines).



Depending on the resolution in the signal, the Line Select provides different information.

- If a signal is SD, HD, 3G:
 - ◆ the *Line* number is the selected line, including vertical blanking;
 - ◆ if the signal is interlaced format, the *Fields* readout is below the Line number;
 - ◆ the *Pic Line* number is next to Line; the Pic Line is the active line number, or numbers, selected.
- If a signal is UHD, 4K:
 - ◆ the *Line* number is the selected raster line,
 - ◆ the *SDI Line* is the selected line including vertical blanking,
 - ◆ the *link* number appears below the SDI Line.

In link, the letters (A-D) refers to the physical links. The numbers (1-4) refers to the virtual links. For example, A3/62 indicates it is physical link 1 and virtual link 3 (in a 2-sample interleave, 12G transport).

Stop Display Application

The Stop Display provides a tool to monitor video signals, with a variety of transfer functions, in a consistent manner. It helps the director of photography, cinematographer, and lighting engineer.

Note: Stop Display is enabled with Option MP2-PROD and is affected by the Gamma and Color Gamut settings. For additional information regarding these settings, see [Configure and Select Virtual Inputs](#).

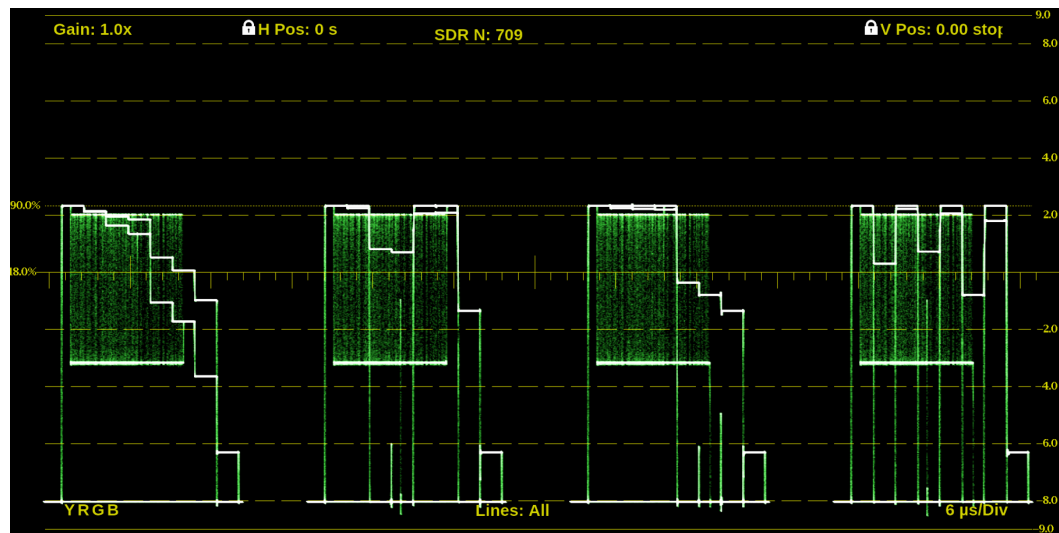

Stop Display Settings Menu

Open the Stop Display Settings menu:

1. Select the **Tiles** icon ().
2. Select the tile with the Stop Display application.

3. Select the **Tile** icon ().

Note: The Move icon () is in the settings menu header. Select this icon to move the settings left or right.

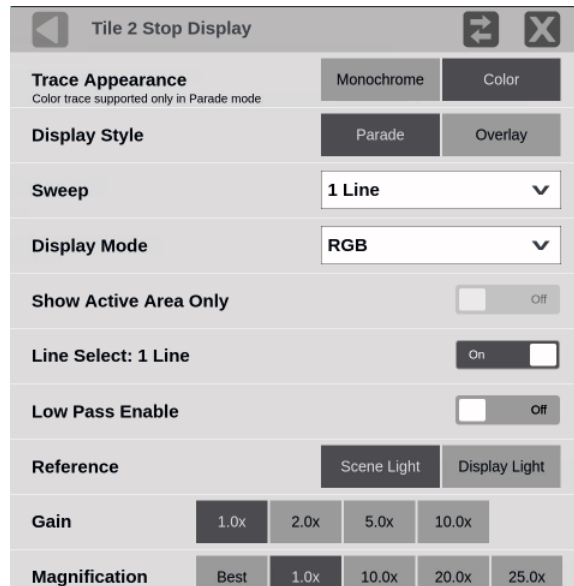

Trace Appearance

To change the colors of the parade traces, select Monochrome or Color.

Monochrome: Displays all traces in a conventional green.

Color: Displays the components of the traces in the colors described in the Display Mode, for example the components in RGB mode are shown in red, green, and blue.

Note: The Color setting only works when Display Style is set to Parade. The Overlay mode displays the traces in green.

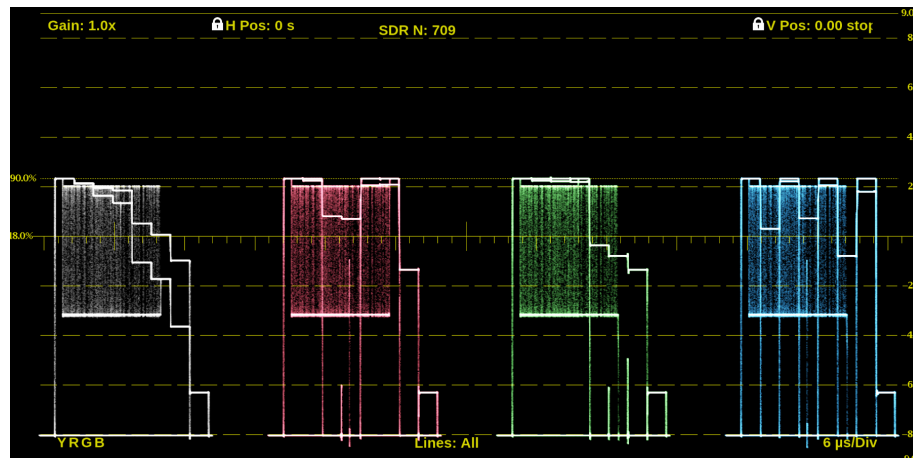

Display Style

Choose how the signal components are displayed in the active tile; use the Display Style buttons to select:

Parade: All the components are shown one beside the other. This setting allows the traces to appear in the described colors if it is selected in Trace Appearance.

Overlay: All the components are drawn at the same location so they appear one on top of the other. This trace is always displayed in green.

Sweep

Select the Sweep menu and select the waveforms to view between the lines or fields or make timing measurements on them. The available sweep options depend on which display style is active.

- When the Parade display style is active you can select from 1 line or 1 field.
- When Overlay display style is active you can select from 1 line, 2 line, 1 field, or 2 field.

Display Mode

Select the Display Mode menu and select from the display choices (only available while displaying SDI inputs). These options turn components in the YRGB mode on or off.

Note: The inputs are only shown in their colors if Trace Appearance is set to Color.

Y: Displays the input as Luma (Y) components—R, G, and B components are off.

RGB: Displays the input as Red (R), Green (G), and Blue (B) components—Y component is off).

YRGB: Displays the input as Y, R, G, and B components.

Show Active Area Only

Set to **On** to remove the trace of vertical and horizontal blanking data.

Line Select

Select the picture lines to monitor:

- Set to **Off** to monitor all lines.
- Set to **On** to select the 1 line to monitor in the display.

To select a line to monitor, select the Line Sel. button and enter a specific line.

If 1 Line is selected, the display only shows results for the selected line in the picture. The line can be selected using the on-screen tools; see [Line Select Function](#). Or the line can be selected directly on the Picture.

Low Pass Enable

This setting is useful for isolating a specific characteristic of the input.

- Set to **On** to display only the low frequency of the signal.
- Set to **Off** to display the full available bandwidth.

Reference

Choose between Scene Light and Display Light. The trace represents light level in the vertical axis.

- Scene Light shows a stop graticule in the vertical axis and is fixed regardless of the selected Gamma. It is used for scene setting and camera exposure adjustment.
- Display Light shows a nits graticule in the vertical axis and is fixed regardless of Gamma selected. It is used for mastering the content for a targeted HDR system.

This turns on the “Best” option in Gain.

The example is of the Display Light setting.

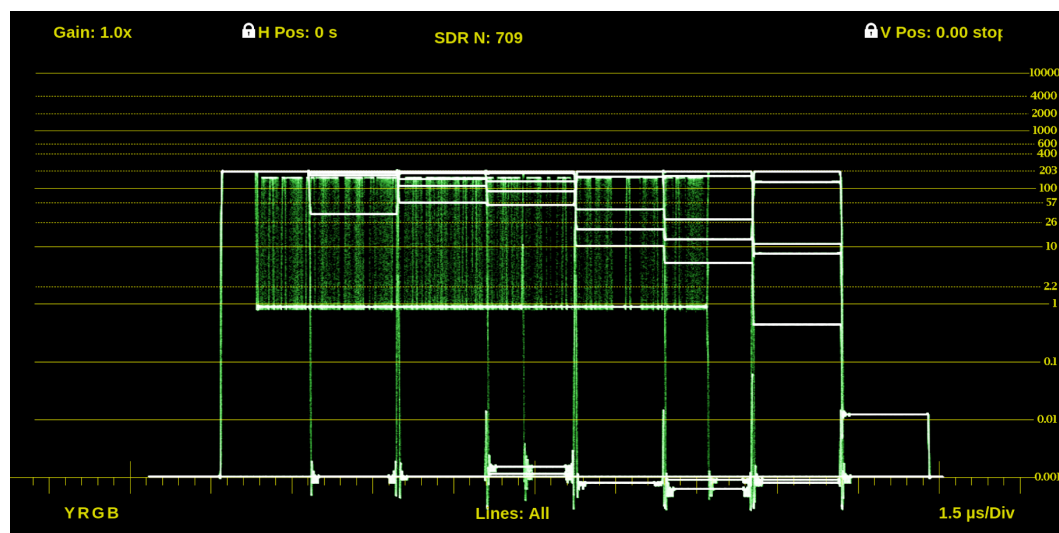

Gain

Set the gain to 1.0x, 2.0x, 5.0x, or 10.0x. Best is available when Display Light, in Reference, is selected. Display Light maximizes the trace height with 1,000 nits of brightness.

Magnification

Select from the options to set magnification to Best, 1.0x, 10.0x, 20.0x, or 25.0x.

Stop Display Application On-screen Tools

You can change the gain, display mode, and sweep—without opening the Stop Display menu—through on-screen tools. Select the tool/button for the setting you want to adjust. All the available tools are located on the top and bottom of the display and are highlighted for a few seconds when the application is first opened or if you select anywhere in the middle of the application tile.

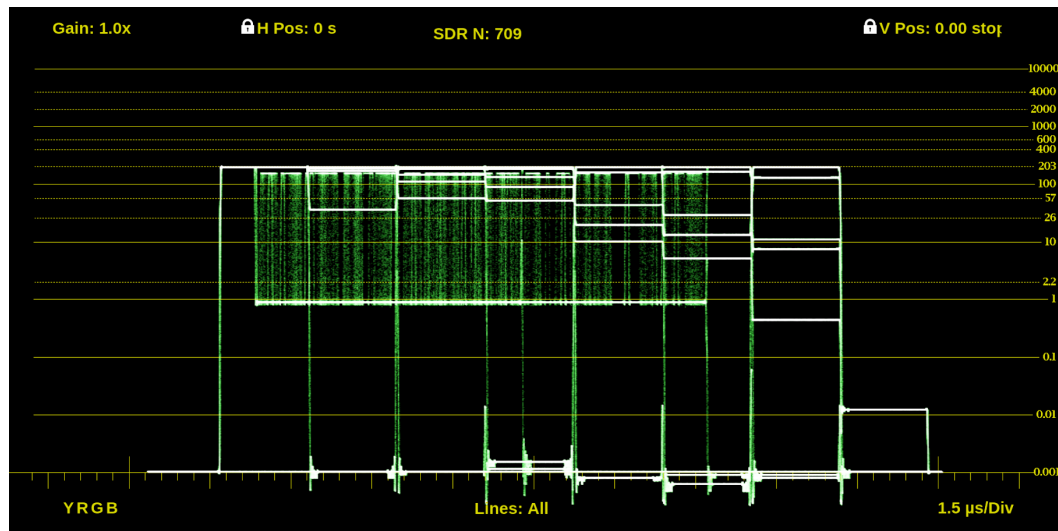

Gain

Increase or decrease the magnification of the trace display.

1. Select **Gain** to open the magnification menu.
2. Select one of the preset fixed-gain values: 1.0x, 2.0x, 5.0x, or 10.0x.
3. Select the **Reset** icon (🔄) to reset the gain to 1.0x.

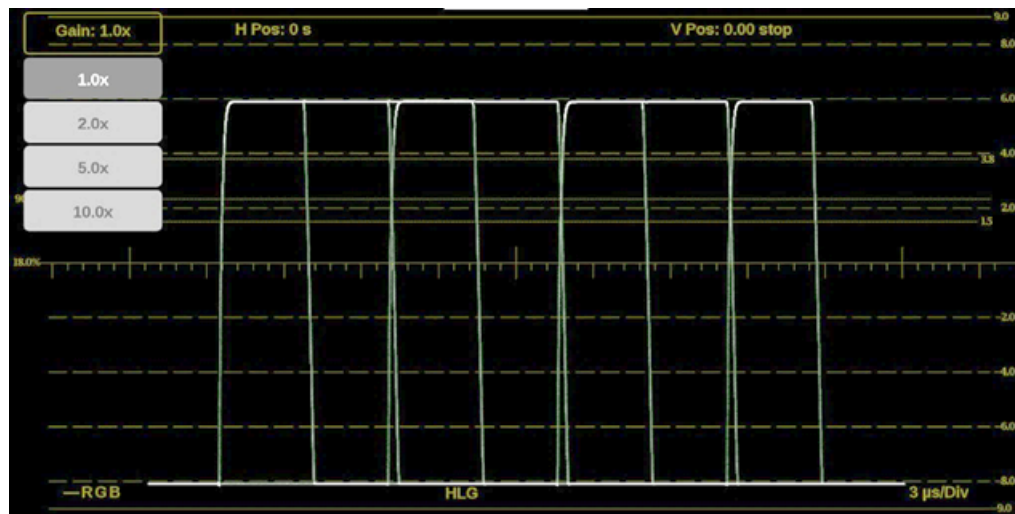

Horizontal and Vertical Position

Adjust the position of the trace display.

1. Select **H Pos** to allow adjustment of the horizontal trace.
 - Select-and-drag to move the trace on the touchscreen. This method can be performed without using the button.
 - Use a mouse scroll wheel to move the trace.
 - For incremental adjustments, select the + (plus) or - (minus) buttons to adjust the horizontal position.
 - Select the **Reset** icon () to reset the horizontal position adjustment to default.

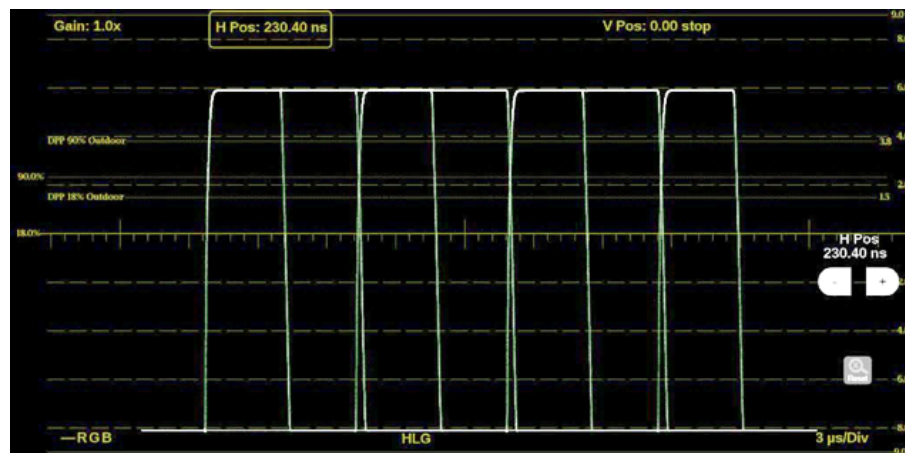

2. Select **V Pos** to allow adjustment of the vertical trace.
 - Select-and-drag to move the trace on the touchscreen. This method can be performed without using the button.
 - Use a mouse scroll wheel to move the trace.
 - For incremental adjustments, select the + (plus) or - (minus) buttons to adjust the vertical position.
 - Select the **Reset** icon () to reset the vertical position adjustment to default.

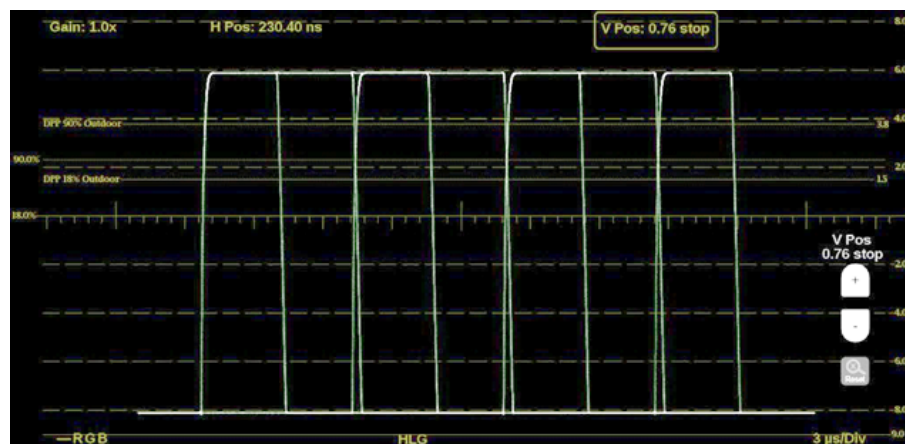

Display Mode

Change the displayed signal components:

1. Select the button in the bottom-left corner of the application to expand the available display options.
2. Select the components to view:
 - In the list of components, select the letter of the color to remove it. For example, select R to remove the red trace.
 - Select the letter of a removed component to make it visible.

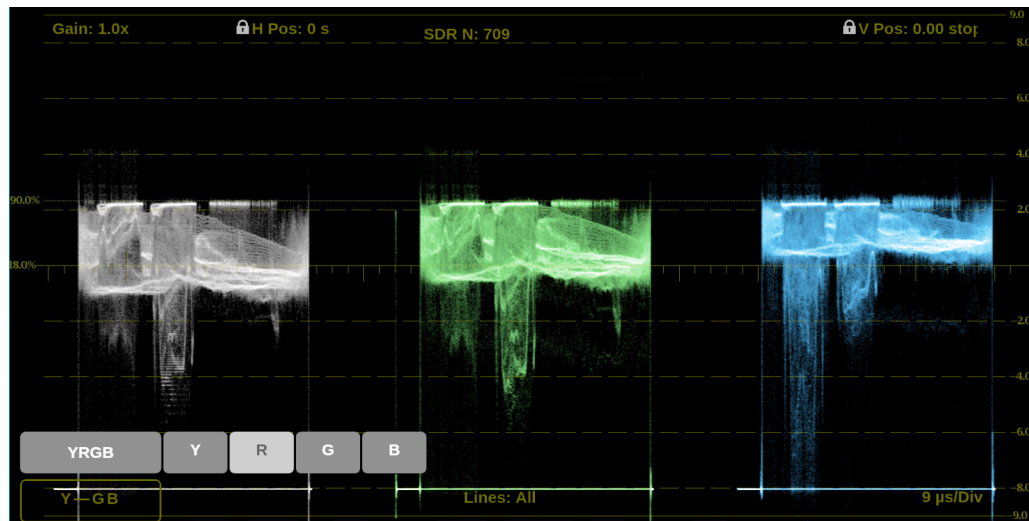

Display Format

Change the Display Style, Sweep, and Magnification of the Stop Display.

1. Select the button in the bottom right corner of the application to expand the available display format options.
2. Select the **Mag** option to set the magnification to Best, 1.0x, 10.0x, 20.0x, or 25.0x.

3. Select Parade or Overlay to switch between the Display Style options. The options depend on which Display Style is active.
 - When Parade display style is active, select from 1 line or 1 field.
 - When Overlay display style is active, select from 1 line, 2 line, 1 field, or 2 field.

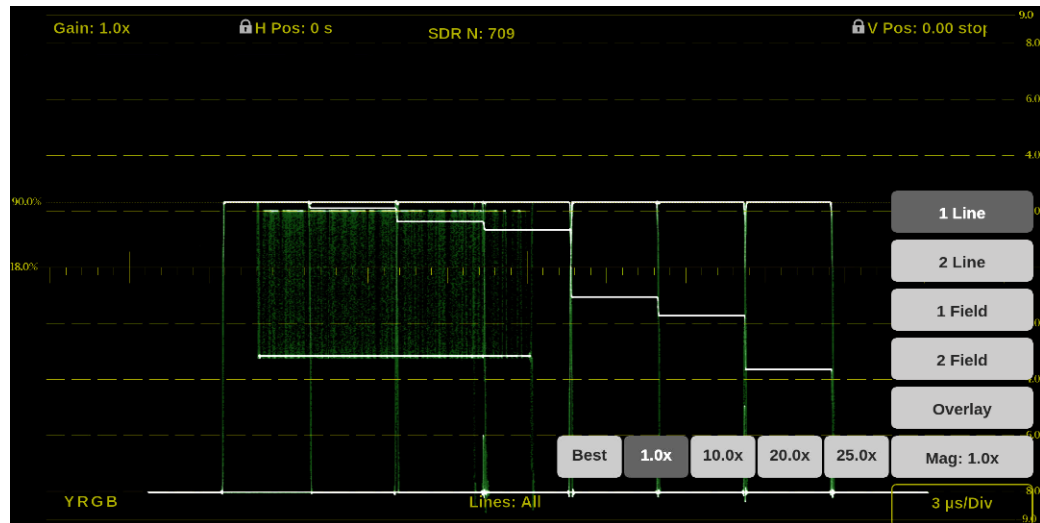

Line Select Function

Line Select allows you to select a single picture line to monitor in the display. By default All Lines is selected and all lines are monitored.

Note: The same line is selected in any trace display if line select is enabled.

To turn on Line Select (and choose the line to monitor):

1. Select the **Lines** at the bottom of the tile.
2. Select **1 Line**.
 - To scroll through lines, select the + (plus) or - (minus) buttons.
 - To enter a specific line to monitor:
 - ◆ Select Line Sel. and enter the line on the keypad,
 - or
 - ◆ In the Picture application, use the line-select cursor (for active lines).

Depending on the signal resolution, the Line Select provides different information.

- If a signal is SD, HD, or 3G:
 - ◆ the Line number is the selected line, including vertical blanking;
 - ◆ if the signal is interlaced format, the Fields readout is below the Line number;
 - ◆ the Pic Line number is next to Line; the Pic Line is the active line number, or numbers, selected.

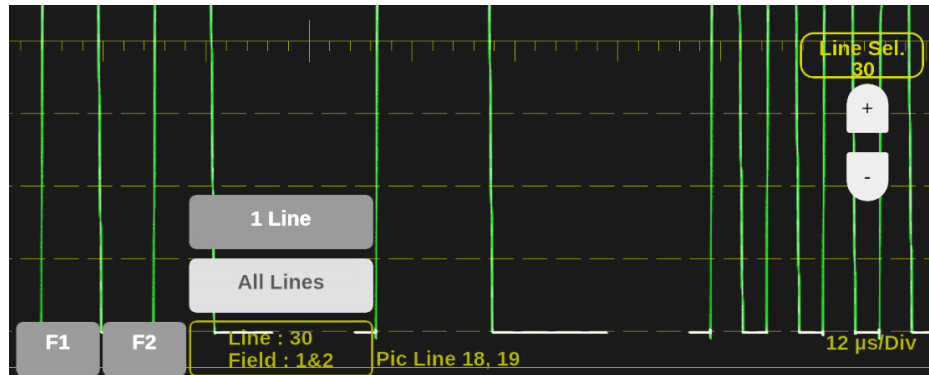

- If a signal is UHD or 4K:
 - ◆ the Line number is the selected raster line,
 - ◆ the SDI Line is the selected line including vertical blanking,
 - ◆ the link number appears below the SDI Line.

In link, the letters (A-D) refers to the physical links. The numbers (1-4) refers to the virtual links. For example, A3/62 indicates it is physical link 1 and virtual link 3 (in a 2-sample interleave, 12G transport).

CAM Application

The CAM application displays the output of up to four cameras to check color levels and balance when MULTI input is selected.

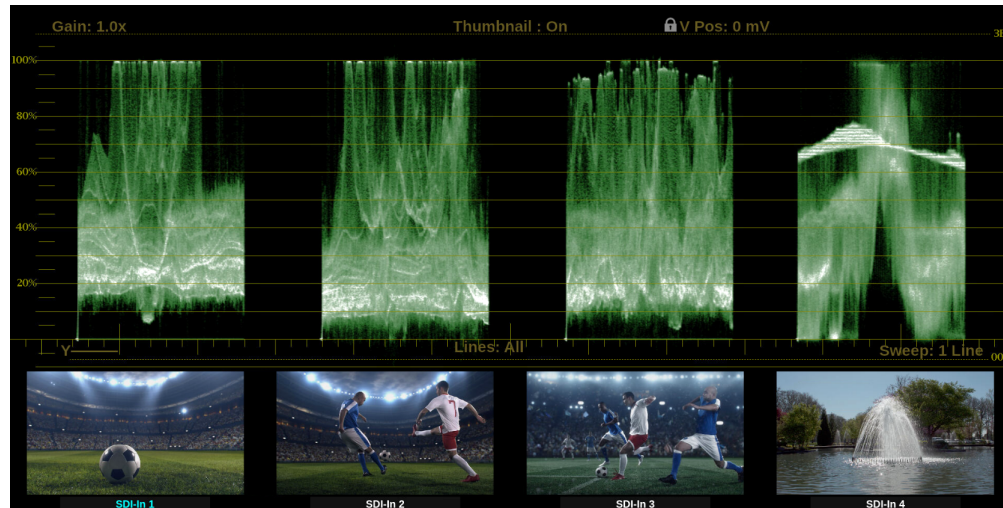

Source Label Overlay

The source label overlay is format information that includes the picture format, frame rate, structure, and gamma curve for that channel. It appears at the bottom of the CAM application tile, over the camera thumbnails if they are displayed.

The format information overlay can be set to turn off after 5 seconds, dim after 5 seconds, or never turn off. The format information does not appear if the instrument is not in multi-input mode.

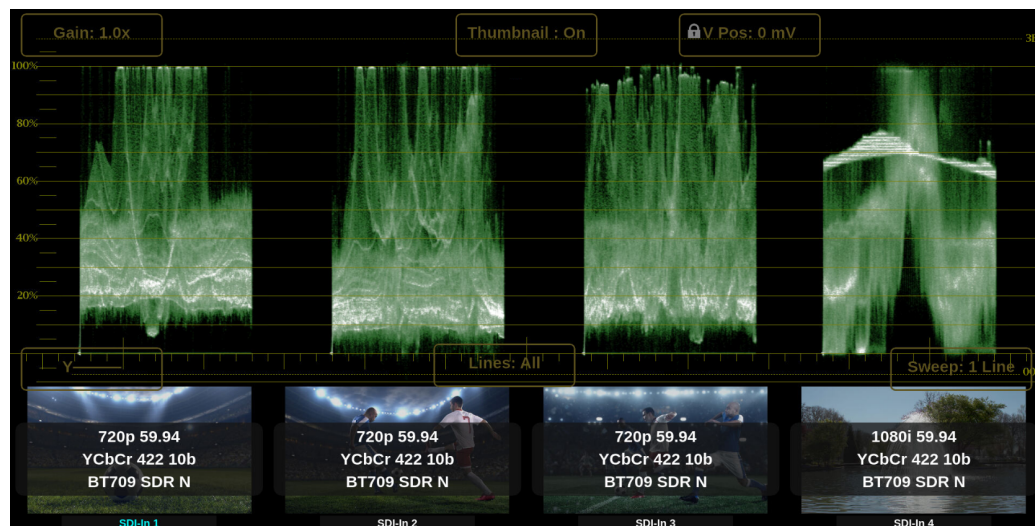

To change the format information overlay:

1. Select the **Settings** icon (⚙️) and then select **Display**.
2. Select **MULTI INPUT** and select the Source Label Timeout option.

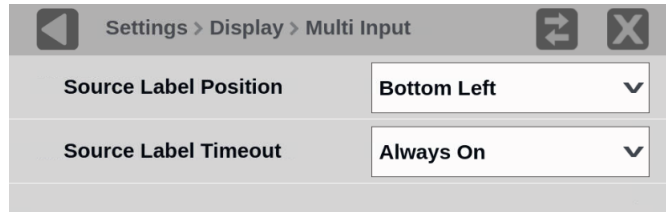

C AM Settings Menu

Open the CAM Settings menu:

1. Select the **Tiles** icon (🧩).
2. Select the tile with the CAM application.
3. Select the **Tile** icon (⚙️).

Note: The Move icon (↔️) is in the settings menu header. Select this icon to move the settings left or right.

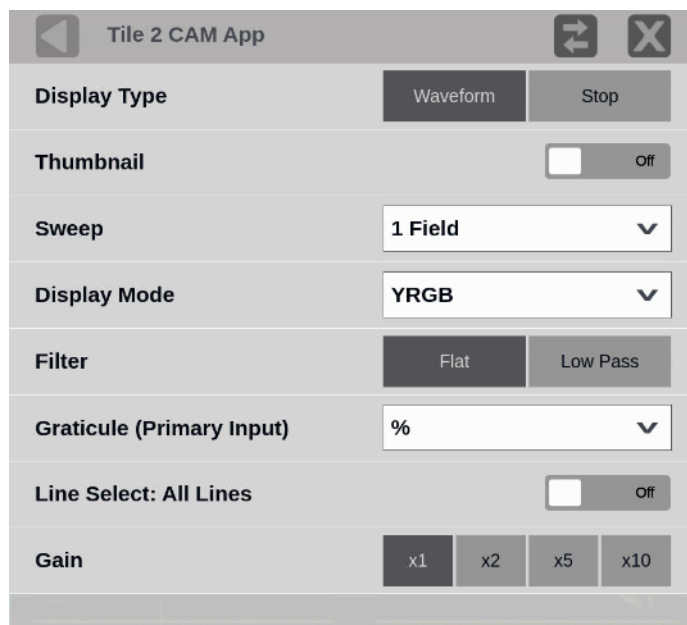

Display Type

Set to Waveform or Stop. The Waveform setting makes the CAM application act like the Waveform application. See [Waveform Application](#). The Stop setting makes the CAM application act like the Stop Display application. See [Stop Display Application](#). To use the Stop setting in the Display Type, the MP2-PROD license is required.

Thumbnail

Set Thumbnail to **On** to show a small picture of each input at the bottom of each input channel.

Sweep

Select the Sweep menu and select 1 Line or 1 Field sweep rate.

Display Mode

Select the Display Mode menu and select an option:

Y: Displays the input as White (Y) for the Luma component. This display is the YRGB mode with the Red (R), Green (G), and Blue (B) components turned off.

RGB: Displays the input as R, G, and B components.

YRGB: Displays the input as Y, R, G, and B components.

Filter

Select one of the buttons to set the waveform filter. This is useful for isolating a specific characteristic of the input. For example, you can enable a Low Pass filter for quick camera exposure setting.

These filters are available:

Flat: Display with the full available bandwidth.

Low Pass: Display only the low frequency part of the signal.

Graticule

Select the Graticule menu and choose a vertical scale value. There are different options depending if the Display Type is set to Waveform or Stop.

In multi-input the primary input is used for graticule selection. When inputs have different gammas, select the input of interest as the primary input to get the correct graticule.

The Code Value vertical unit is a hex value. The Stop, Reflectance, and Nits scale are drawn differently depending on the gamma setting in the input menu.

Waveform Options

- The %, value is a fixed graticule. It is compatible with the traditional waveform scales.
- The Stop graticule is the Scene light graticules that are used for scene setting and camera exposure adjustment.
- The Nits graticule is the Display light graticule and is used for mastering the content for a targeted HDR system.

Stop Options

- The Log Nits graticule is the Display light graticule and is used for mastering the content for a targeted HDR system using Stop application processing.
- The Log Stops graticule is the Scene light graticules that are used for scene setting and camera exposure adjustment using Stop application processing.

Line Select

Line Select allows you to choose the raster lines to monitor in the display. Either All Lines or 1 Line can be selected.

Set the control to **On** to select 1 Line to monitor. If Line Select is set to On (Line Select: Line 1), the display only shows results for the selected line in the picture. The line can be selected using the on-screen tools; see [Line Select Function](#).

Set the control to **Off** to monitor all lines.

Gain

Set the vertical gain of the trace display to 1, 2, 5, or 10 times.

Choose Inputs for CAM Application

The channel images shown in the CAM application are determined by the Select channels in the Multi Input menu. The channels are chosen from those listed in the Input menu. Up to four channels can be shown in the CAM application at one time.

The instrument can show up to four trace applications (Waveform, Vector, Lightning, Diamond, CIE, or Stop Display) at the same time. Each input channel in the CAM application acts as one of those trace applications. That is, if three tiles are showing trace applications, the CAM application can only show one input; if the CAM application is showing four inputs (inputs coming into the instrument), no other tiles can show trace applications.

To automatically give the CAM application access to the four trace applications, change the CAM application tile to full screen. Up to four channels are immediately available in the CAM application.

To select channels to see in the CAM application:

1. Select the **Input** icon () in the Status bar.
2. Select the Multi Input menu button from the Input bar.

Note: If "Multi:" is not in the Input menu and the Multi menu button is not active, the MP2-MULTI option might not be installed.



3. Set Multi Input to **ON**.

4. Set Edit Mode to **ON**.

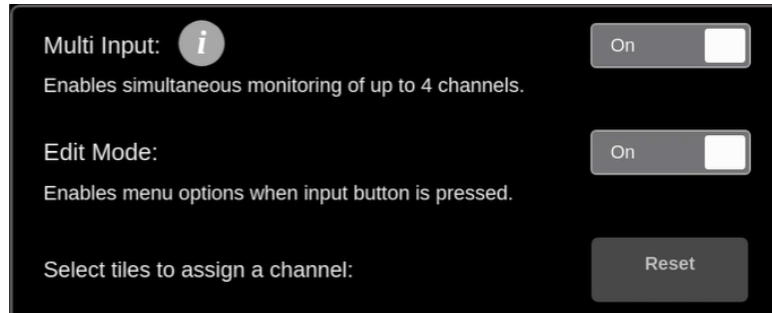

5. Set the inputs in Select channels:

- Add a channel to the Select channel list; select the channel in the menu at the bottom of the screen and select **Add Channel**. The CAM application shows the channel in the tile immediately.

Note: Select Make Primary to enable the graticules for the needed gamma.

The example shows 3 channels in the Select channel list from the Input menu, so the CAM application shows those 3 channels in the order they are in the Input menu, not the order they are chosen for the Select channel list.

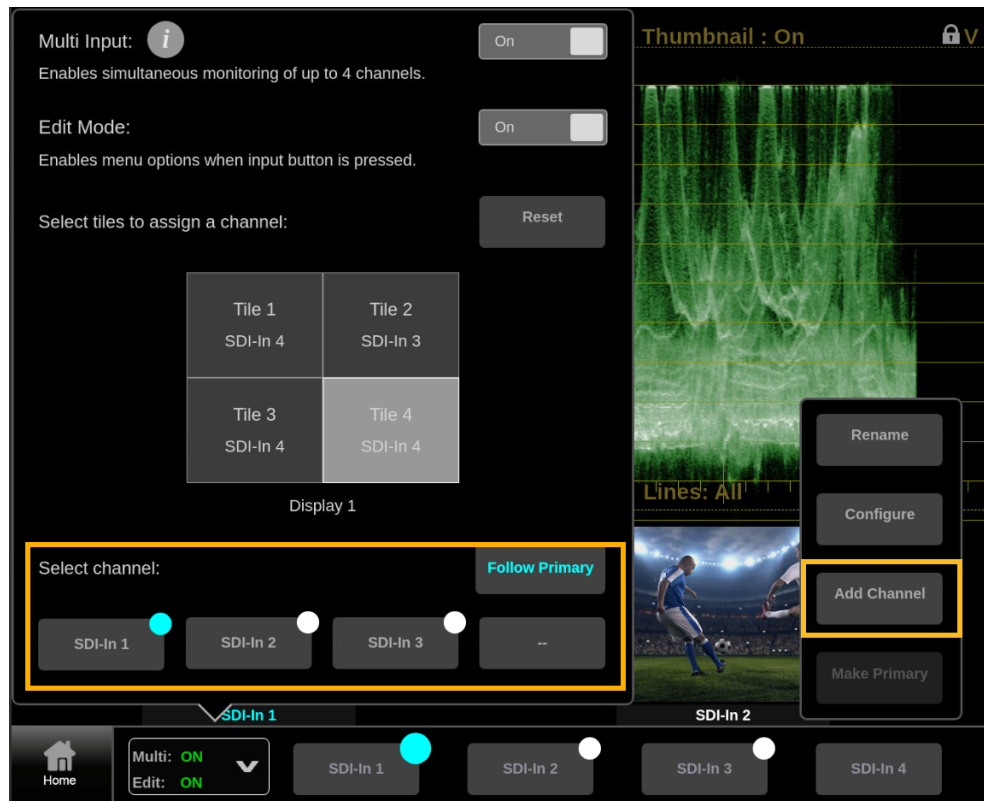

- Remove a channel from the Select channel list; select the channel in the Input menu and select **Remove Ch**. The CAM application removes the channel from the tile immediately.

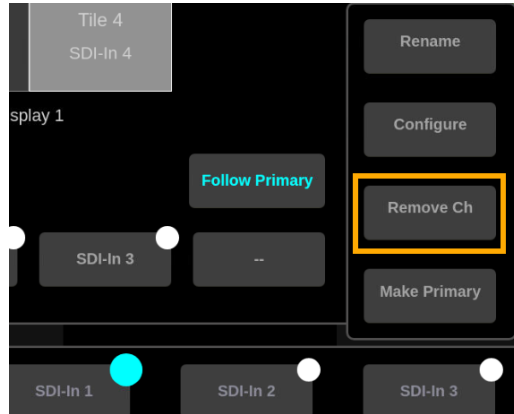

6. Select the channel in the Input menu again to close it.
7. Select the Multi Input menu button again to close the menu.

CAM Application On-screen Tools

You can change the gain, horizontal position, vertical position, thumbnail (on or off), display mode, line select, and sweep rate—without opening the CAM Settings menu—through on-screen tools. Select the button for the setting you want to adjust. All the available tools are located on the top and bottom of the display and are highlighted for a few seconds when the application is first opened or if you select in the tile heading.

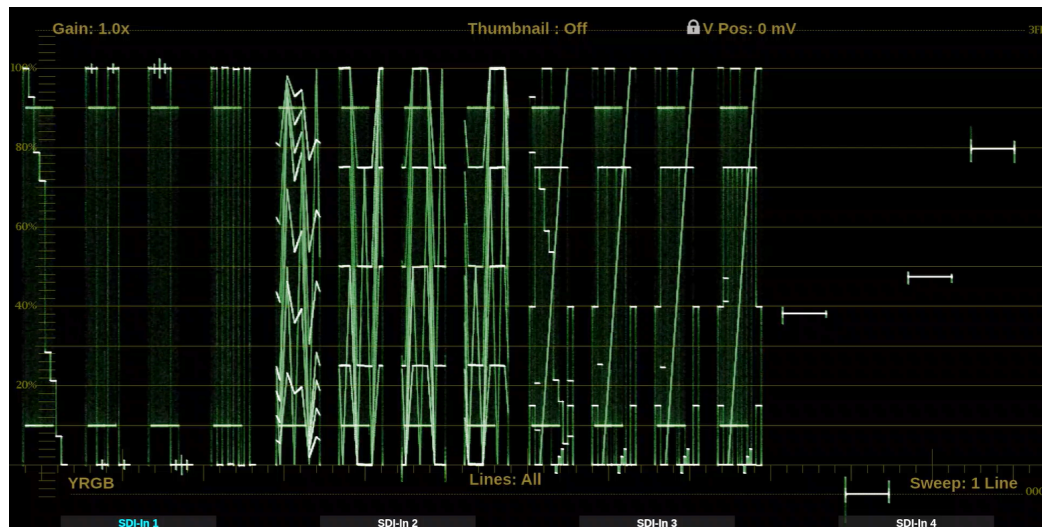

Gain

Increase or decrease the vertical gain of the trace display.

1. Select **Gain** to open the menu.
2. Select one of the preset gain selections: 1.0x, 2.0x, 5.0x, or 10.0x.

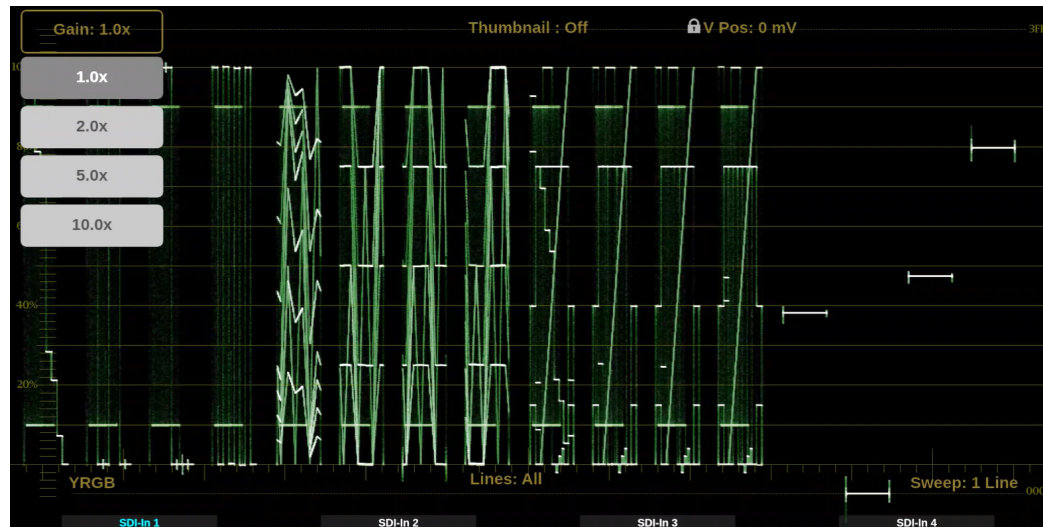

Thumbnail

Select **Thumbnail** and then select **Thumbnail : Off** to turn *on* the thumbnail under the CAM signal image.

Select **Thumbnail : On** to turn the thumbnail *off*.

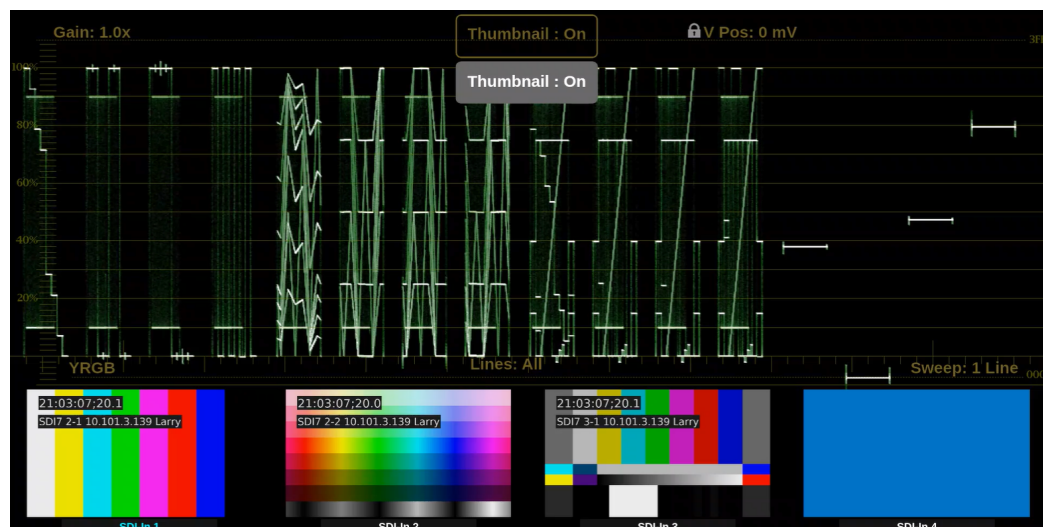

Vertical Position

Select **V Pos** to adjust the vertical trace. Select the button to turn the lock off and on.

- Select-and-drag to move the trace on the touchscreen. This method can be used if the setting is locked or not. The V Pos button must be unlocked (no lock-symbol) for the select-and-drag to work.
- For incremental adjustments, select the plus (+) or minus (-) buttons to adjust the vertical position.
- Select the **Reset** button () to move the signal image back to 0.

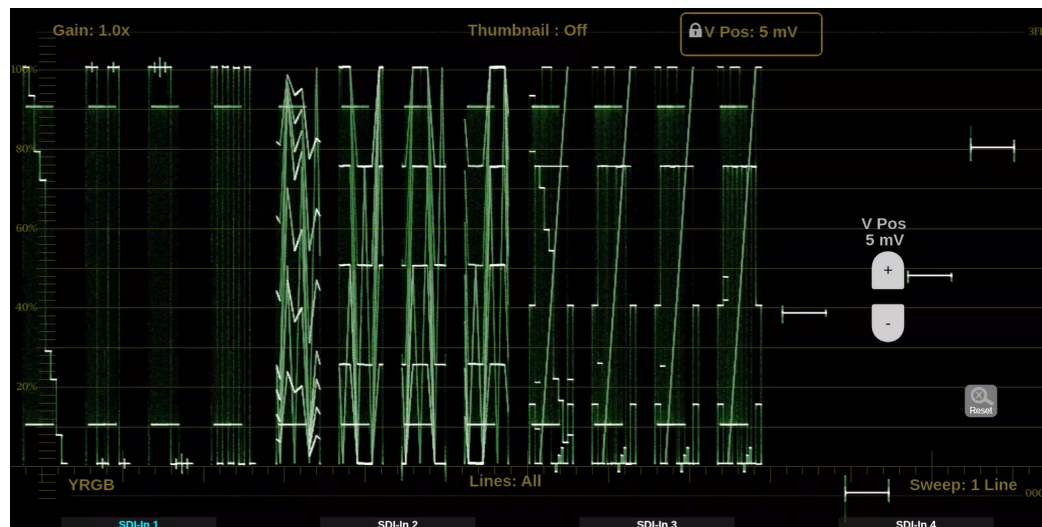

Display Mode

Change how the waveforms are displayed.

1. Select the button in the bottom left corner of the application to expand the available display options (the button label varies depending on the last option selected).

2. Select the components to monitor:

- In the waveform list of components, select the letter of the component to remove it. For example, select G to remove the green component from the waveform.
- Select the letter of a removed component to make it visible.

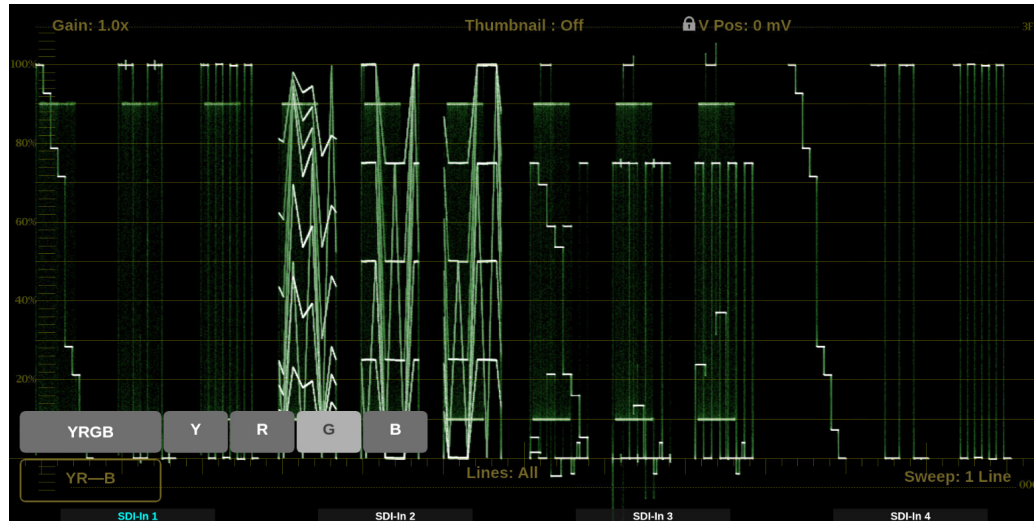

Line Select Function

Line Select allows you to select a single raster line to monitor in the display. By default *All Lines* is selected and all lines are monitored. The same line is selected in any trace display if Line Select is enabled.

To turn on Line Select (and choose the line to monitor):

- 1. Select *Lines* at the bottom of the tile.**

2. Select 1 Line.

- To scroll through lines, select the plus (+) or minus (-) buttons.
- To enter a specific line to monitor: select **Line Sel.** and enter the line on the keypad.

To turn Line Select off and monitor all lines, select the **Lines** button at the bottom of the tile and select **All Lines**.



Sweep

Change the sweep to 1 line or 1 field:

Select the button in the bottom right corner of the application and select 1 Line or 1 Field.

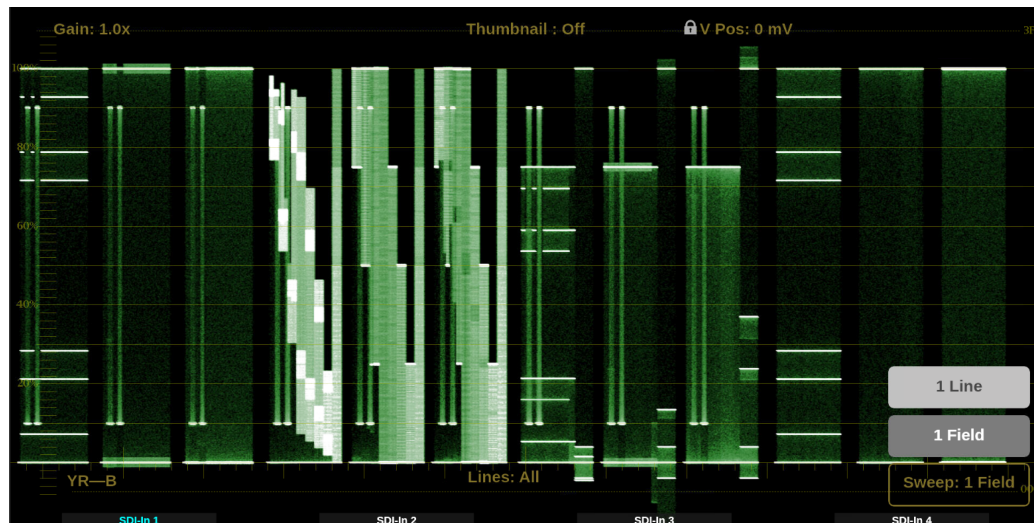

Picture Application

The Picture display lets you see the picture generated by the video signal.



(Copyright 2008, Blender Foundation / www.bigbuckbunny.org)

Note: Tiles displaying the Picture application in multi-input mode and viewing secondary inputs do not show content from all 4K contribution links.

Note: In full-screen mode, there is no cropping. Pictures are decimated horizontally or vertically to obtain the correct aspect ratio. This decimation may cause some artifacts.

Picture Settings Menu

Open the Picture Settings menu:

1. Select the **Tiles** icon ().
2. Select the tile with the Picture application.

3. Select the **Tile** icon (⚙️).

Note: The Move icon (↔️) is in the settings menu header. Select this icon to move the settings left or right.

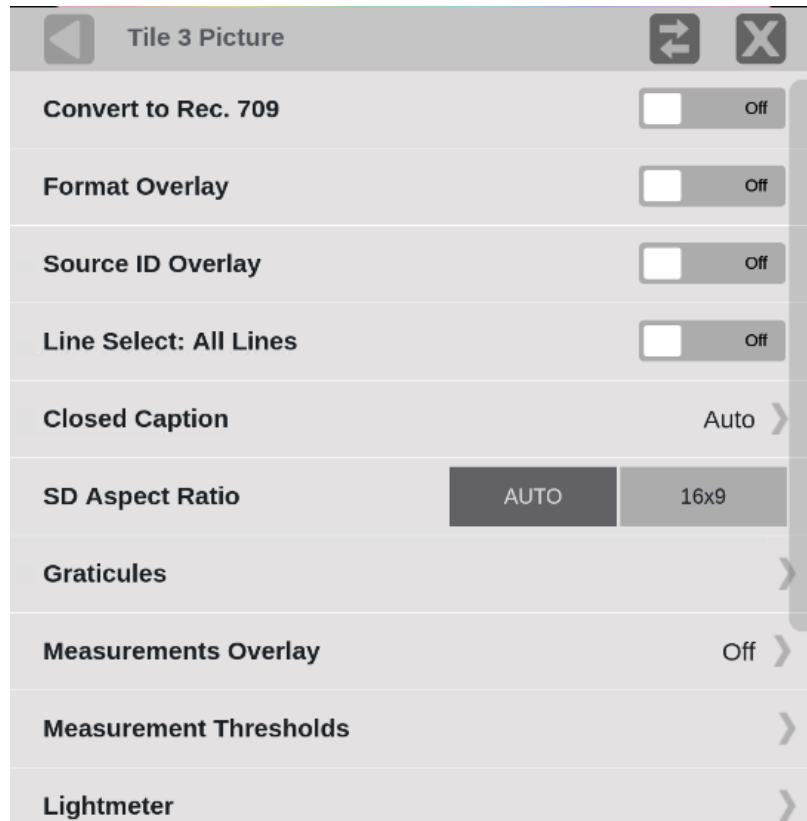

Convert to Rec. 709

Note: In multi-input mode, Convert to Rec. 709 only works with the primary channel.

Set to **On** to allow the trace displays to convert camera logs to Rec. 709 (requires Option MP2-PROD).

Note: Convert to Rec. 709 mode is not supported for SD signals.

Format Overlay

Set to **On** to display the format information on top of the picture. Select-and-drag the format information window to set the location.

Source ID Overlay

Note: In multi-input mode, Source ID Overlay only works with the primary channel.

Provides an overlay of the video source on the Picture application. The source data carries ANC data conforming to ST 291M. The default DID is 0x53 and SDID is 0x49. Set them as required. The source ID is limited to a maximum 15 ASCII characters.

To enable the Source ID Overlay, open the Picture Setting menu and then set the Source ID Overlay to **On**. Select-and-drag the overlay to the correct location on the application.

Line Select

Allows you to select the picture line to monitor a line in the available trace displays, including Waveform, Stop, Vector, Diamond, Lightning, and CIE. Either All Lines (Line Select is Off) or 1 Line (Line Select is On) can be selected.

If 1 Line is selected, a horizontal line appears on the picture. Select-and-drag the line to choose a line to monitor. The selected line number is noted on the line.

Closed Caption

These are settings for closed captions/subtitles formats and services. See [Closed Caption/Subtitles: Details](#) for more information about this feature.

SD Aspect Ratio

For SD (standard definition) only: allows you to choose between AUTO (the AFD data will set the aspect ratio) and 16x9. Selecting an option with non-SD input will have no effect.

Graticules

Allows control of safe area graticules, including AFD and AFD data. See [Graticules: Details](#) for more information about this feature.

Measurements Overlay

The visibility of the available picture measurements can be adjusted in this menu. See [Measurement Overlay: Details](#) for more information about this feature.

Measurement Thresholds

Threshold for the HDR picture measurements are made in this menu. See [Measurement Thresholds: Details](#) for more information about this feature.

Lightmeter

Displays the light level (in nits or stops) at the point marked by the Lightmeter cursor in the Picture display. (See [Lightmeters: Details](#) for more information about this feature.)

Input Gamma

Reports the input Gamma set in the Settings menu for the selected input.

False Color

When a display is selected, false color is turned on. Three false-color displays are available, which apply a color palette to the picture to highlight attributes associated with images. (See [False Color: Details](#) for more information about this feature.)

Closed Caption/Subtitles: Details

Note: In multi-input mode, Closed Caption/Subtitles only works with the primary channel.

Note: The Closed Caption/Subtitles conform to ST 334:2015.

In the Picture Settings menu, select **Closed Caption**.

Closed Caption Information Overlay

To turn on the CC Information Overlay, set the CC Information Overlay to **On**.

The CC Information Overlay appears in the selected Picture tile.

Closed Caption Formats

CC/Teletext: Selects the closed captions/subtitles format and service.

The overlay provides closed captions/subtitles format and service information. To move the overlay, select-and-drag it to the new location.

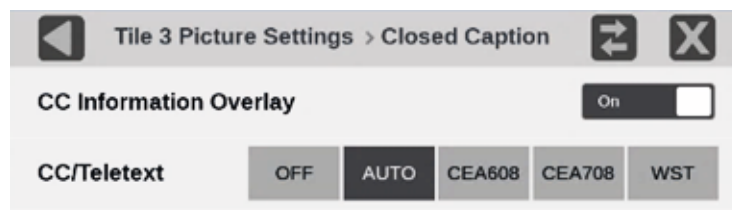

Select a format to decode and open the service options.

OFF: Turns off the closed caption decoding. The overlay remains in the Picture tile if it is on.

Auto: Detects and selects the closed captions/subtitles format in the signal and presents the service options. Select the appropriate input.

CEA608: A standard format of closed captions/subtitles data used in the U.S., Canada, and Mexico for analog TV transmissions. If a service has no activity for 10 seconds, it is considered missing.

CEA608 Channel: Select, from 1 to 4, the appropriate input.

CEA708: A standard format of closed captions/subtitles data in the U.S. and Canada for digital TV transmissions. If a service has no activity for 10 seconds, it is considered missing.

CEA708 Service: Select, from 1 to 6, the appropriate input.

WST: Also called Teletext, it is a standard format of closed captions/subtitles used in many parts of the world. Support includes OP-47 and 2031.

Teletext Page: Set the page number: Select the up or down arrow, or select the number and use the pop-up keypad, to enter the page number for your region.

ARIB: This is a standard B24 of decoding.

ARIB Type: Select—from HD, SD, and Mobile—the appropriate format.

Note: Each Picture tile can select a closed caption format and a service.

Supported character sets: Latin, Cyrillic (1/2/3), Hebrew, Arabic, Greek

Supported national option sets: English, German, Italian, French, Portuguese/Spanish

Graticules: Details

Note: Graticules conform to industry standard ST 2016-1.

This explains how to turn safe area graticules on and off, including AFD.

Open Graticules Menu

In the Picture Settings menu, select **Graticules**.

The Graticules menu opens.

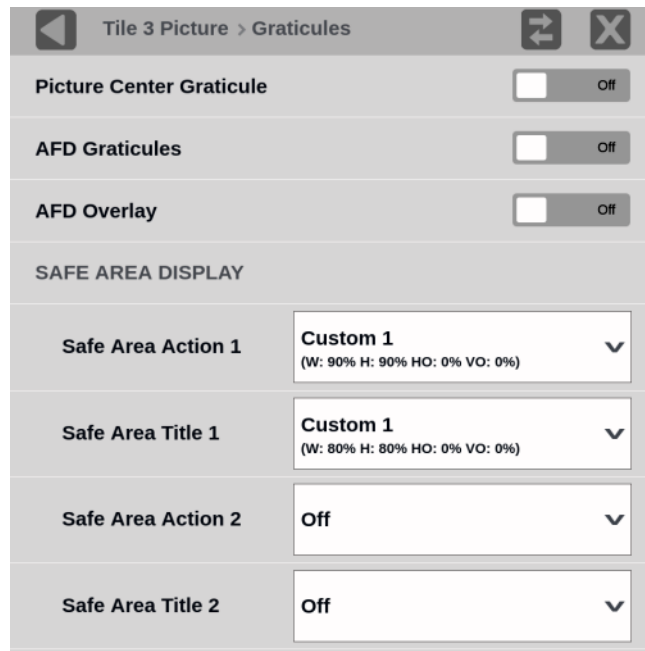

AFD Graticules

The AFD graticule frame is based on input AFD data. These are not adjustable.

Turn on AFD options

1. In the Graticules menu, select from the options as needed:
 - To show the center crosshairs, set **Picture Center Graticule** to **On**.
The crosshairs appear in the middle of the selected Picture tile, whether there is AFD data or not.
 - To show the AFD frame, set **AFD Graticules** to **On**.
The dashed line is the received AFD data aspect ratio. If AFD data is not present, the graticule will not be displayed.
 - To show the AFD on-screen information, set **AFD Overlay** to **On**.
The AFD data description appears in the selected Picture tile, whether there is AFD data or not.

Note: The Bar1 and Bar2 data complies with ST 2016-1-2009.



Change element colors

To change the colors of the AFD graticule and the Picture Center Graticule see [Set Graticule Colors](#).

Select Safe Area Graticules

This section explains the other graticules that can be turned on, besides the AFD.

Turn on Safe Areas

1. In the Picture settings menu, select **Graticules**.
2. Select from the Safe Area Action and Safe Area Title menu options:

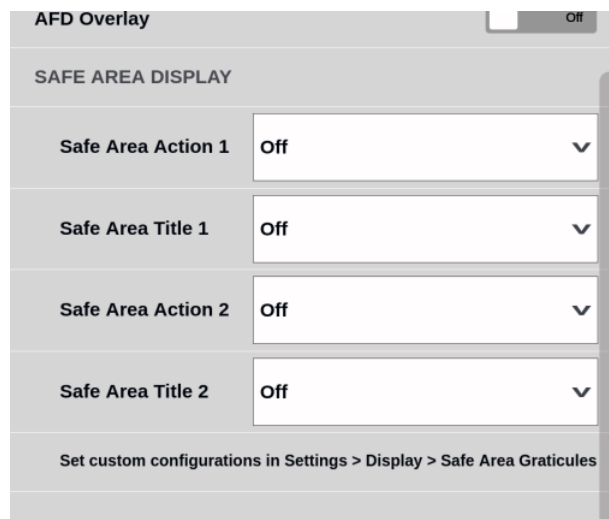

Safe Area Standards

Select a ratio for the Safe Area Standards (SMPTE, ITU, and ARIB TR-B.4) to turn on the graticules in a Picture tile. To change the Safe Area Standard that is used, see [Set Safe Area Graticules](#).

SAFE AREA DISPLAY	
Safe Area Action 1	Off
Safe Area Title 1	Auto
Safe Area Action 2	4x3
Safe Area Title 2	14x9
	16x9

- The Safe Area *Action* 1-2 menus turn on a *solid* line defining a safe area.
- The Safe Area *Title* 1-2 menus turn on a *dashed* line defining a safe area.

Note: The safe areas for each Picture tile are independent of other Picture tiles. That is, you can change a Picture tile to display any, all, or none of the Safe Area Action or Title options, while nothing changes in any other Picture tiles.

1. Select from the safe area ratio options: 4x3, 14x9, or 16x9.
The standard safe area in a Picture tile changes, depending on the ratio selected.

Note: These ratios do not affect the AFD graticules.

SAFE AREA DISPLAY	
Safe Area Action 1	16x9
Safe Area Title 1	16x9
Safe Area Action 2	Off
Safe Area Title 2	Off

Custom Safe Areas

Select the Custom 1 and Custom 2 options to see the custom-defined space in a Picture tile. These safe areas are set independently and, if selected, override the standard safe area selection. The specifics of each custom graticule are listed under the Custom 1, Custom 2 names.

For details on how to set the Custom Safe Areas, see [Set Custom Safe Areas](#).

There are only two custom options in each menu.

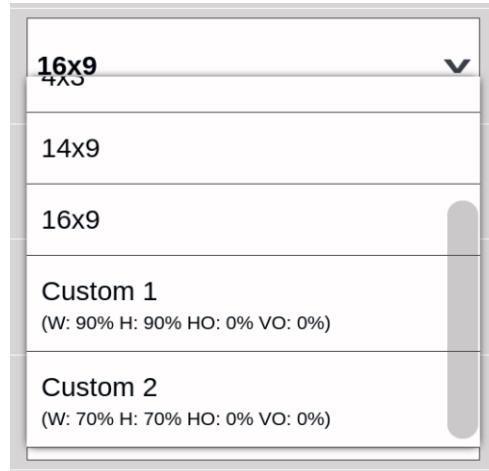

Picture Measurements

Note: In multi-input mode, Picture Measurements only works with the primary channel.

To turn on the overlay containing a selectable set of picture measurements (including HDR measurements):

Select the Picture application, and in the Applications menu, select the **Tile** icon (⚙️).

If needed, select the measurement overlay and drag it to set the location.



Measurement Overlay: Details

1. In the Picture Settings menu, select **Measurements Overlay**.
2. Set Measurements Overlay to **On**.

The Measurements Overlay appears in the Picture application. After it is visible, the overlay window can be selected and dragged to any location in the Picture tile.

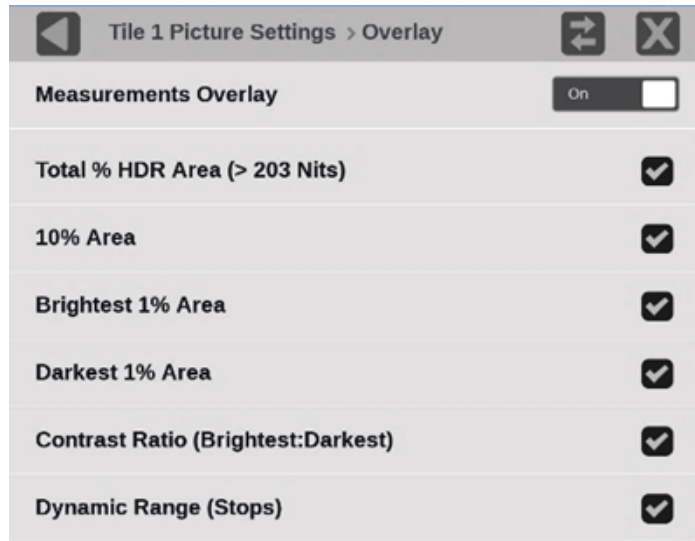

3. Select the checkboxes of the picture measurements to make them visible in the overlay. Clear the checkboxes to remove the measurements from the overlay.
For many of the parameters a threshold setting is required. See the Measurement Threshold menu for setting these thresholds.

These measurements are available—settable thresholds are indicated by x:

- Total percent HDR area the nits threshold for this measurement can be set.
- X percent area, in nits
- Brightest x percent Area, in nits
- Darkest x percent Area, in nits
- Contrast Ratio (Brightest:Darkest)
- Dynamic Range (stops = $\text{Log}_2(\text{Brightest } x \text{ percent} / \text{Darkest } x \text{ percent})$).

Measurement Thresholds: Details

To set the thresholds for those picture measurements that require them:

In the Picture Settings menu, select **Measurement Thresholds**.

Note: These settings also affect the HDR alarm settings, see [HDR](#) in the alarms table.

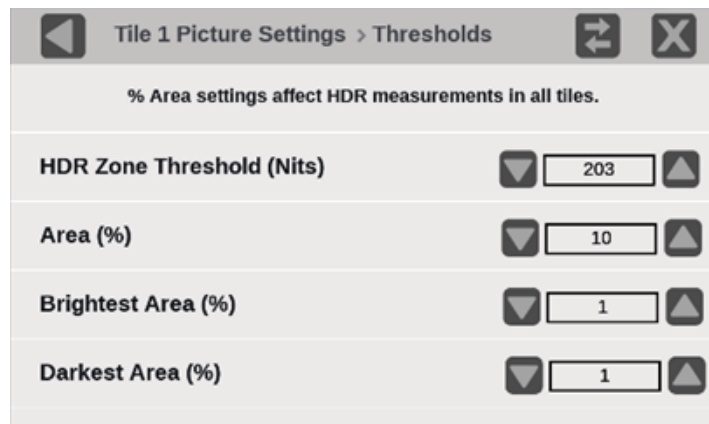

The threshold settings:

HDR Zone Threshold (Nits): Any picture value higher than this threshold, in nits, is considered to be in the HDR zone.

Area (%): Defines the brightest percentage of the picture used to determine the bright threshold in nits.

Brightest Area (%): Defines the brightest percentage of the picture used to determine the HDR threshold in nits.

Darkest Area (%): Defines the darkest percentage of the picture used to determine the dark threshold in nits.

Lightmeters: Details

Note: In multi-input mode, Lightmeters only work with the primary channel.

The Lightmeters measure the light level, in nits or stops, at the point marked by the Lightmeter cursor in the Picture application. Proper operation requires selecting the appropriate Gamma Curve in the input settings. (See [Select the Gamma Curve menu and select the option.](#))

Select the Picture application and then, in the applications menu, select the **Tile** icon ().

Note: The readout is the average luminance of a 5x5 pixel area in a 1920x1080 picture, a 10x10 pixel area in a 3840x2160 picture, and a 20x20 pixel area in a 7680x4320 picture.

Turn on Lightmeters Cursors

1. Select the Picture application and then, in the applications menu, select the **Tile** icon (⚙️).
2. Select **Lightmeter**.
3. Set the Lightmeter Overlay to **On**.
4. Select the number of needed Lightmeter cursors (up to 5).

Note: The Lightmeters all use the same method for measurements. The color of the Lightmeter cursor is just for identification.

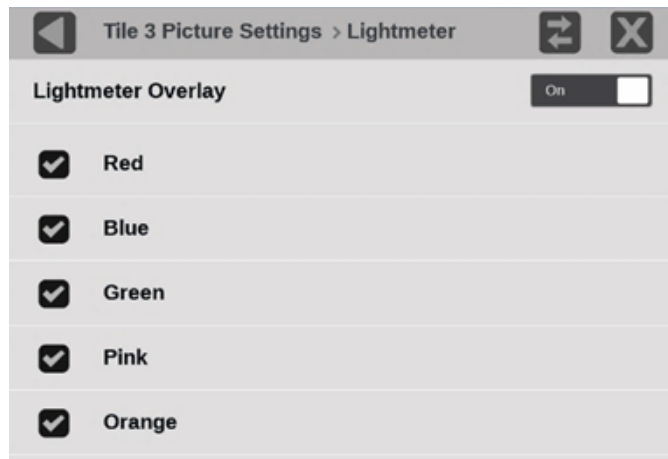

The Lightmeters are visible in the Picture application.

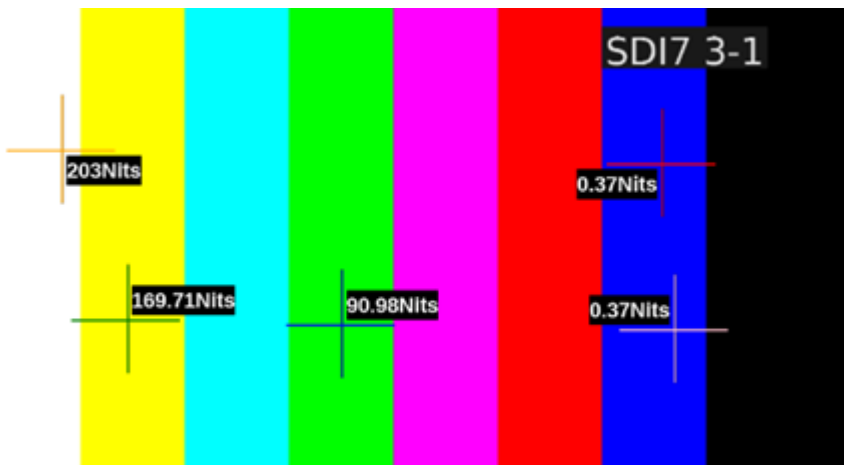

Adjust Lightmeters Cursors

- To move the Lightmeter cursors, select any part of the crosshairs or the measurement numbers and drag the target to the new location. The measurement updates automatically.
- To remove a selected Lightmeter cursor from the Picture, clear the checkbox of the color in the Picture Settings menu.
- To remove all the Lightmeters cursors from the Picture, clear the checkboxes of all the Lightmeter colors or set the Lightmeter Overlay to Off.

False Color: Details

1. Select the Picture application and then, in the applications menu, select the **Tile** icon ().
2. From the False Color list, select a false color palette. The false color turns on and shows the selected option:

Gamut: Used for a quick check of gamut compliance to Rec. 709 and P3 gamut limits. Select Outside 709 or Outside P3 to change the color palette in the Picture tile.

% Area: A fixed false-color palette is applied to regions of the picture with Brightest, Area, and Darkest. Any or all of these false colors can be disabled by clearing the check next to the color in the % Area menu.

Enable	% Area		
<input checked="" type="checkbox"/>	 Red	Brightest	0%
<input checked="" type="checkbox"/>	 Pink	Area	0%
<input checked="" type="checkbox"/>	 Violet	Darkest	0%

Luminance: Create a user-defined false color palette based on luminance values.

Note: In multi-input mode, Luminance False Color works with both the primary and secondary channels.

The Luminance False Color display replaces pixels that fall within a specified range of nits or stops values to a color that you specify. Up to 9 configurable ranges can

be defined. For example, you can use the Luminance False Color display to tag pixels that are within a specified HDR range.

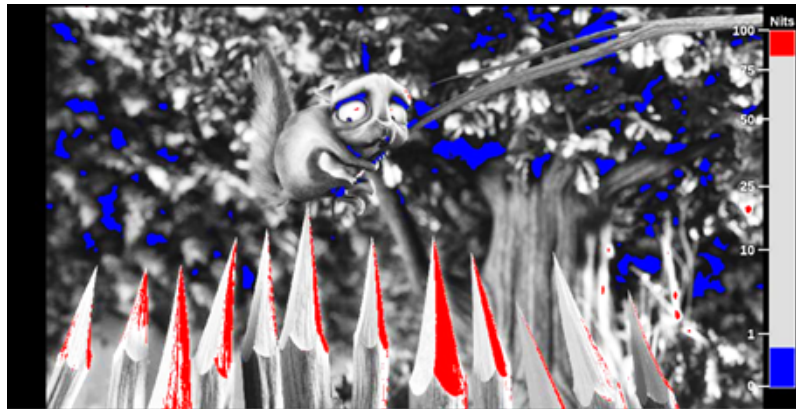

(Copyright 2008, Blender Foundation / www.bigbuckbunny.org)

The false color ranges are defined in nits or stops depending on the gamma curve set up in the input (select the **Settings** icon (⚙️) and then select **Input**). If a camera-based gamma curve is set, such as S-Log2, the false color ranges are in stops. If a display-based gamma curve is set, such as SDR Narrow, the false color ranges are in nits.

Turn on Meter Overlay

In the Luminance menu, set Meter Overlay to **On** to enable the Meter Overlay in the Picture tile.

The overlay shows the false color definitions in nits or stops made in the Luminance False Color table at the bottom of the menu. The overlay can be moved to the right, bottom, left, or top of the image by dragging the meter with a mouse or by touch.

By default, the false colors are defined according to the BT.2408 specifications if a display-based gamma curve is set for the input, or a typical camera specification if a camera-based gamma curve is set for the input. If changes are made to the false color ranges in the Luminance False Color table, an indication that the default settings have changed is shown.

Select **Default** to reset the ranges to their default settings.

Customize False Color

The Luminance False Color table allows you to customize up to 9 different false color ranges as defined by a minimum and maximum nits or stops value. The pixel values are displayed in either Code Value or Percent but selecting the readout in the table header.

Specific colors can be displayed by selecting the checkbox in the Enable column of the table. You can change the Nits or Stops range even if the checkbox is not set.

To adjust the Nits or Stops range, select anywhere in the row you want to change. You can adjust the Minimum and Maximum value in the range using the up and down arrow keys, or select in the number field and a numeric entry keypad appears. Enter the line number and select **Enter** to close. The false colors in the Picture and the Meter Overlay are updated as adjustments are made.

If the range for one color overlaps the range for another color, the color that is higher in the table overlaps the colors lower in the table.

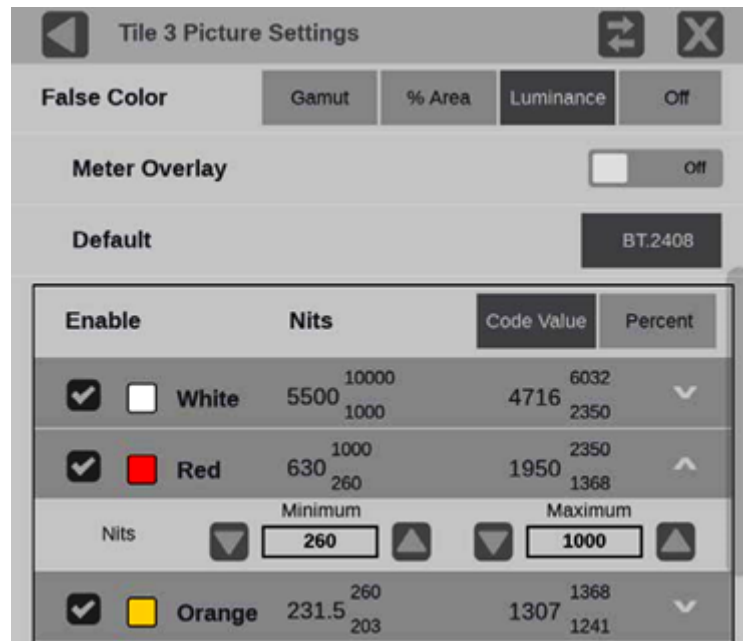

False Color can also be turned on and off in the tile:

1. Select in the Picture tile, which brings up a False Color setting.
2. Select the False Color option to change between on and off.

The false color shown is the most recent false color display selected in the Picture Settings menu.

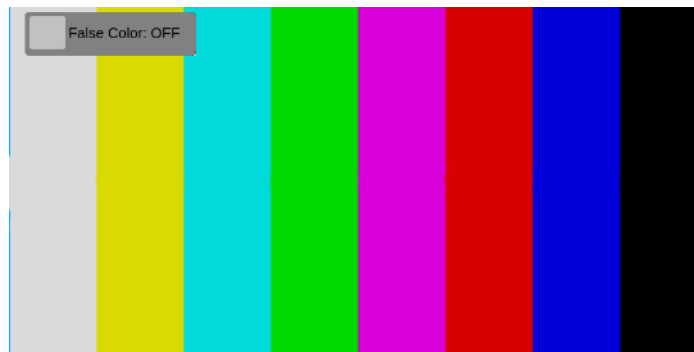





Extended Full-Screen Display

In an extended display, it's possible to enlarge the Picture application even more than full screen. The picture expands to cover the status bar.

Note: This option is only possible with the Picture application in an extended display.

There are two ways to change between full- and maximum-screen.

- Double tap:
 - Each double tap in the Picture application changes the display to the next size: from quarter-screen mode (or half-screen if it was set) to full-screen, to maximum-screen mode (the status menu is covered), and back to quarter- or half-screen mode.
- Select the icons:
 - A.** In the Picture application, in the extended display, select the **Tiles** icon () to open the Application bar and select the full-screen icon ().
The Picture application changes to full-screen mode.
 - B.** Select the extended full-screen icon ().
The Picture application changes to extended full-screen mode.
 - C.** Select the reduce icon () to return to half- or quarter-screen mode.

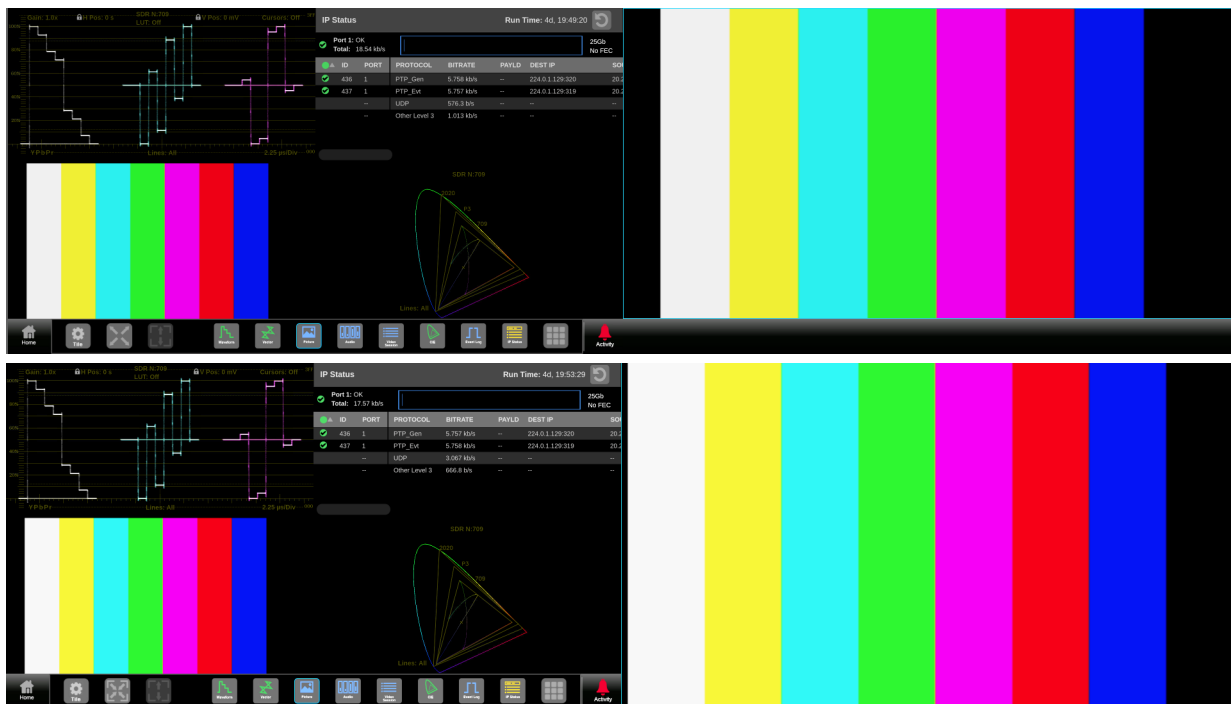

Video Session Application

Note: In multi-input mode, Video Session only works with the primary channel.

Use this application to view various performance parameters of the SDI video signal or the decoded IP stream. Select any of the four tab titles to view the associated information: SDI Format, VPID 352, Bit Level, or CRC Status.

STATISTICS	STATUS	ERR FIELDS	ERR SECS	% ERR FIELDS
Y Chan CRC Error	OK	1719	746	0.0419
C Chan CRC Error	OK	1719	746	0.0419
Y Anc Checksum Error	OK	89	5	0.0022
C Anc Checksum Error	OK	215	6	0.0052

Elements of Video Session Display

The elements at the top of the Video Session application:

INPUT: Shows the selected input source on the top line and shows the detected format, sample structure, and transport of the input signal on the second line.

Display tabs: Select one of the four tabs. Each of the tabs has a status indicator to provide a quick view of the status of the parameters contained in each tab.

- **SDI FORMAT:** This page shows the status of various SDI signal parameters on the input signal.
- **VPID 352:** This page shows the status of the ST 352M VPID on the input signal. For 3G-SDI signals, VPID is required on the primary link (Link A).
- **BIT LEVEL:** This page shows if there are any stuck bits in the input signal.
- **CRC STATUS:** This page shows the status of CRC and Checksum errors in the video signal.

Run Time: The instrument maintains a running monitoring session for the Video Session application. The Run Time readout displays the amount of time that has elapsed during the current monitoring session. The time is displayed as

DD, HH:MM:SS. DD is number of days, HH is number of hours, MM is number of minutes, and SS is number of seconds.

Reset icon: Select the Reset icon (⏮) to restart the monitoring session.

Run / Stop icons: When the monitoring session is running (collecting error data), select the Stop icon (⏸) to stop the session. When the monitoring session is stopped (no error data collection and no display updates), select the Play icon (▶) to restart the session.

Elements of SDI FORMAT Tab Display

Use the SDI FORMAT tab display to view the status of various SDI signal parameters on the input signal.

SAV Place Err: Indicates if a Start-of-Active-Video Placement error has occurred.

EAV Place Err: Indicates if an End-of-Active-Video Placement error has occurred.

Field Length Err: Indicates if a Field Length error has occurred.

Line Length Err: Indicates if a Line Length error has occurred.

Line Number Err: Indicates if a Line Number error has occurred.

Ancillary Data: Indicates if Ancillary Data is present in the video signal. The displayed values are either Present or None for SD signals, or Y and C Present and None for HD and 3 Gb/s signals.

Statistics: This section of the display shows the status and statistical values for certain errors. For information about the errors in this section, view the help file in the instrument: When the Video Session is active in a tile, select the HELP button.

Status: Shows the status of the associated error as either OK, Invalid, Missing, or Error.

VPID 352 Tab Display

The VPID 352 tab displays the VPID values of the ST 352M payload. For 3G-SDI signals, VPID is required on the primary link (Link A).

Video Session		Run Time: 1d, 04:32:47		Running	
Input: SDI - SDI-In 3 2048x1080p 59.94 - YCbCr 422 10b - 425M-B 2.970/M Gbps					
SDI FORMAT	VPID 352	BIT LEVEL	CRC STATUS		
Link A1	8Ah 4Ah 40h 1h	BYTE 1 10001010	SMPTE 425.1 Lvl B (1125)		
Link A2	8Ah 4Ah 40h 41h	BYTE 2 01001010	Transport	interlaced	
			Picture	progressive	
			Transfer	SDR	
			Picture Rate	59.940	
		BYTE 3 01000000	Aspect Ratio	Unknown	
			H pixel	2048	
			Color	BT709	
			Sampling Structure	YCbCr 4:2:2	
		BYTE 4 00000001	Luma Color Difference	YCbCr	
			Channel assignment	1	
			Bit Depth	10-bit	

Note: Full- and half-screen modes show the Binary values (shown in the example, under BIT LEVEL), which are hidden in 1/4-screen mode to present a more compact view.

The VPID 352 tab consists of two panes:

Left pane: Shows the presence of a ST 352M payload. The number of data streams determine the number of links, with the VPID values shown in hex. You may select a link to display the decoded VPID information in the right pane.

Right pane: Contains the decoded VPID of the selected link.

BIT LEVEL Tab Display

The BIT LEVEL tab displays any stuck bits in the input signal.

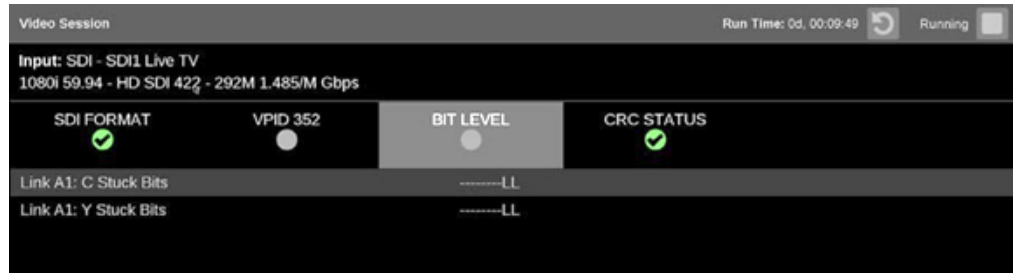

Y Stuck Bits: Displays which of the luminance video bits are stuck. If the readout is "----", then none of the bits are stuck.

Note: For 8-bit video, because the unused bits are always low, "-----LL" is displayed when no other bits are stuck.

C Stuck Bits: Displays which Chrominance video bits are stuck. If the readout is "----", then none of the bits are stuck.

CRC STATUS Tab Display

The CRC STATUS tab displays the status of CRC and Checksum errors in the video signal.

STATISTICS	STATUS	ERR FIELDS	ERR SECS	% ERR FIELDS
Y Chan CRC Error	OK	2	1	0
C Chan CRC Error	OK	2	1	0
Y Anc Checksum Error	OK	0	0	0
C Anc Checksum Error	OK	0	0	0

Note: The instrument uses the RP 165 standard for error checking. For HD and 3 Gb/s signals, the CRCs change on every video line.

Y Chan CRC Error: Displays the status of the Y channel embedded CRC (Cyclical Redundancy Check) that was calculated for the video signal. Using a known test signal, the CRC status can be used to verify integrity through a system. An error means that the Y Channel embedded CRC value does not match the calculated CRC value, which indicates that a transmission error has occurred.

C Chan CRC Error: Displays the status of the C channel embedded CRC (Cyclical Redundancy Check) that was calculated for the video signal. Using a known test

signal, the CRC status can be used to verify integrity through a system. An error means the C Channel embedded CRC value does not match the calculated CRC value, which indicates that a transmission error has occurred.

Y Anc Checksum Error: Displays the status of the Y channel ancillary embedded checksum value that was calculated for the video signal. Using a known test signal, the checksum status can be used to verify integrity through a system. An error means the Y Channel embedded checksum value does not match the calculated checksum value, which indicates that a transmission error has occurred.

C Anc Checksum Error: Displays the status of the C channel ancillary embedded checksum value that was calculated for the video signal. Using a known test signal, the checksum status can be used to verify integrity through a system. An error means the C Channel embedded checksum value does not match the calculated checksum value; this indicates a transmission error has occurred.

The CRC Status display is also divided into four columns:

Status: Shows the status of the associated error:

- **OK:** No error is currently detected.
- **Invalid:** The data for the item is currently invalid.
- **Missing:** The data for the item is currently missing.
- **Error:** The associated error is currently in an error state.

Err Fields: The number of fields, since the last reset, that contained at least one error.

Err Secs: The number of seconds, since the last reset, that contained at least one error.

% Err Fields: Shows a calculated number of the percentage of all fields since the last reset that contained at least one error.

Audio Application

Note: In multi-input mode, Audio only works with the primary channel.

The Audio application provides a level-meter display with multiple ballistic settings, and optional Audio Session and Lissajous with Channel Correlation displays. Audio Session shows instantaneous measurements of the level meters and the Lissajous and Channel Correlation displays show audio phase information. Dolby E decoding can be performed on a specified SDI input channel pair.

Note: The Lissajous, Channel Correlation meter, and Audio Session displays require software option MP2-AUD. Dolby E decoding requires option MP2-DLBY. The 32-channel audio support requires option MP2-FMT-8K.

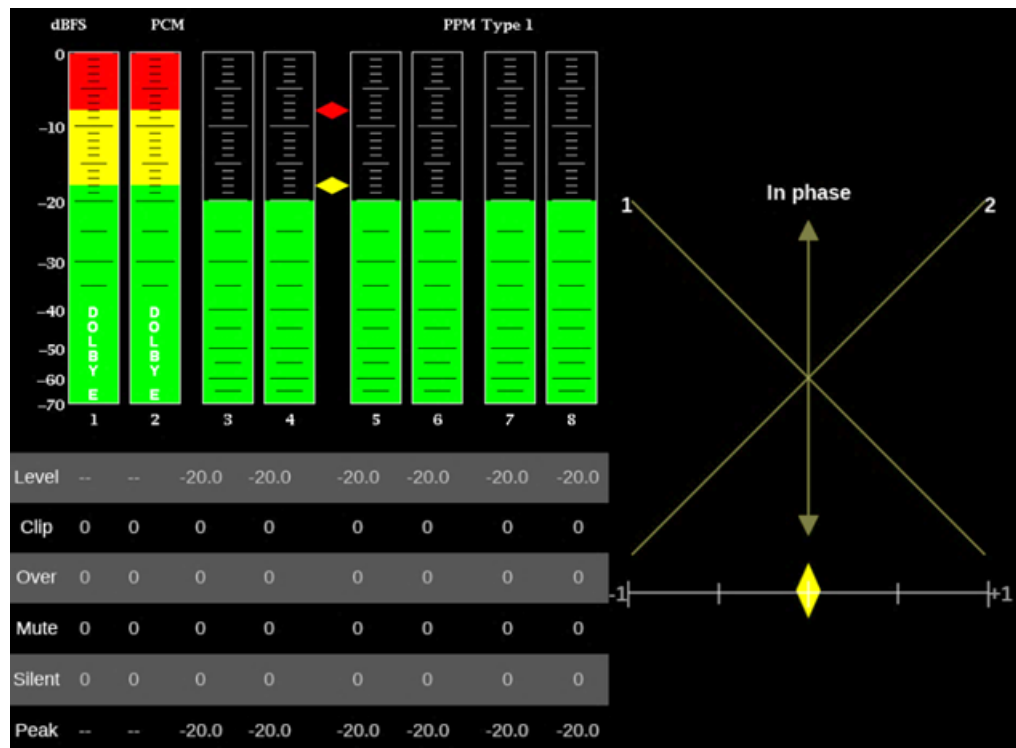

Audio Settings Menu

Open the Audio Settings menu:

1. Select the **Tiles** icon ().
2. Select the tile with the Audio application.

3. Select the **Tile** icon (⚙️).

Note: The Move icon (↔️) is in the settings menu header. Select this icon to move the settings left or right.

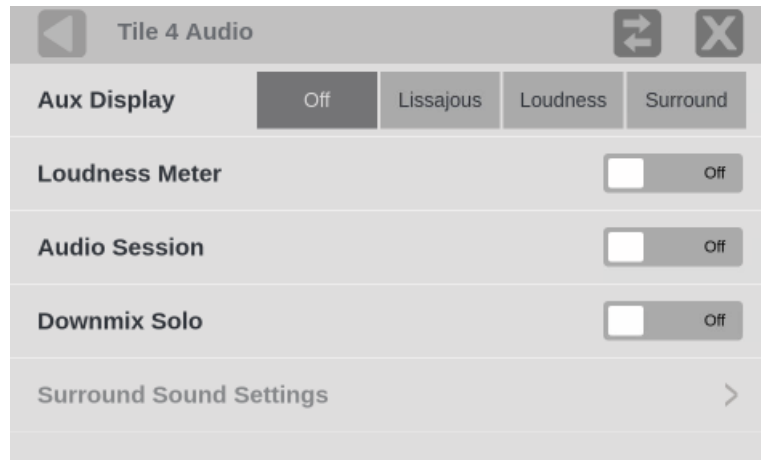

Audio Tile Data

This section describes the parts of the Audio tile and the information available, such as level meters and the Lissajous display. It also explains the measurements in those displays.

Level Meters

Level meters are the vertical bar graphs. The height of the bar indicates the amplitude of the audio program in the corresponding input channel. The meter levels are color coded based on their relationship to the Test level and Peak Program level indicators:

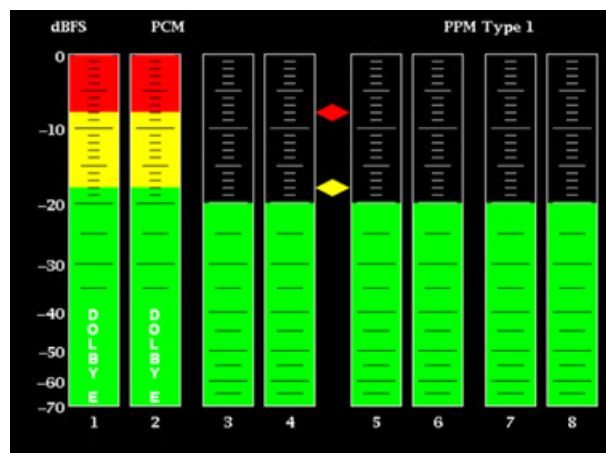

- The meter bars are displayed below the Test level in green.

- Between the Test level and the Peak Program level, the meter bars are displayed in yellow.
- Above the Peak Program level, the meter bars are displayed in red.

For details on how to change the Test level, see [Test Level \(dBFS\)](#).

For details on how to change the Peak Program level, see [Peak Program Level \(dBFS\)](#).

5.1 Channel Order

Changes the order the *right* and *center* channels in any 5.1 surround program are displayed in the level meters:

1. Select the **Settings** icon (⚙️) to open the Settings menu.
2. Select **Audio**.

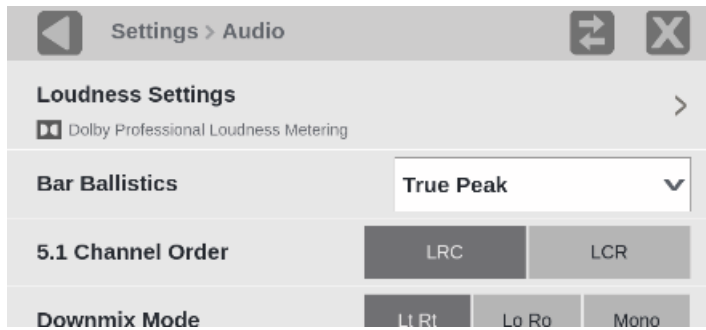

3. In 5.1 Channel Order, select LCR or LRC.

The level meter reorders to *left-center-right* or *left-right-center*.

Note: This setting affects all 5.1 surround programs. If there is a second 5.1 surround program selected, both programs are set to LCR or LRC.

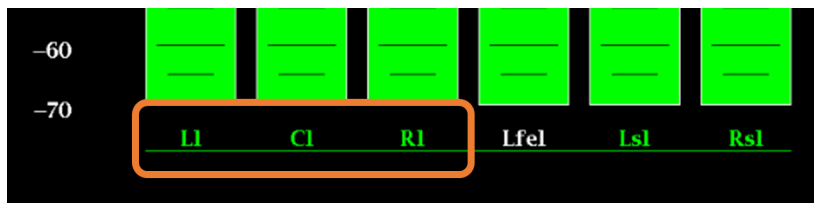
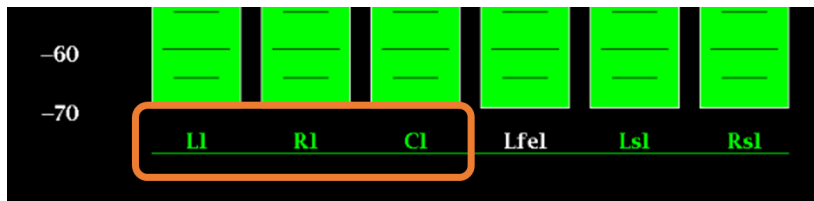

Ballistics

Displays the selected ballistics for the level-meter dynamic response, above the level meter, on the left.

To change the ballistics:

1. Select the Settings icon (⚙️) and then select **Audio**.
2. Select the Bar Ballistics menu and choose the option.

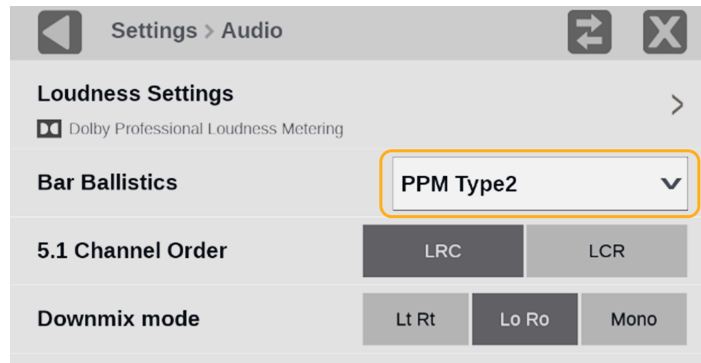

Test Level and Peak Program Level Indicators

The arrows or diamonds next to the level bars indicate the Test level (in yellow) and Peak level (in red) limits for the display. Test level is also known as Reference level or Line-up level.

Level Meter Scale and Units

By default, the units are in dB relative to full scale (dBFS). The 0 dB mark is digital Full scale.

Lissajous Display

The phase of a selected pair of audio channels is plotted on a soundstage plot. Soundstage plots the two channels at 45-degree angles, with the mono combination appearing on the vertical axis, much like a left-right image in a studio.

To select the audio channel pair to plot on the Lissajous display, select the Volume icon (🔊) on the Status bar and choose from the list of available channel pairs.

Channel Correlation Meter

Displays the channel correlation under the Lissajous display.

- For identical or highly correlated signals, the indicator is white and moves to the far right (+1).
- For highly correlated signals, the indicator is green and moves to the right (towards +1).
- For uncorrelated signals, the indicator is yellow and tends to stay in the middle (around 0).

- For anti-correlated signals (one goes up when the other goes down), the indicator is red and moves to the left (towards -1).

Level Meter Bar Messages

This instrument displays information within the level meter bars. These are messages that can appear and are shown in order of priority:

UNLOCKED: The instrument is not locked to an incoming signal on the indicated input channel. Data cannot be decoded and all data and other errors are ignored. This means that if an input is selected, nothing recognizable is present on the input, or if embedded audio is selected, the VIDEO input is unrecognizable.

PARITY: The incoming subframe does not have even parity as specified by the digital audio standards. The data sample is unreliable and is ignored. The level meters and Lissajous display treat the sample as a zero sample.

CRC ERR: The CRC code in the channel status packet is incorrect. Sometimes the CRC code is set to zero, indicating that the signal is missing; when this is the case, this message is not displayed.

MUTE: The number of consecutive all-zero samples equals or exceeds 10.

SILENCE: The signal is below -70 dB for 5 seconds or more.

V BIT: Indicates that the Validity bit is set high for one or more data samples. In the AES/EBU standard, a set validity bit indicates that the sample is not suitable for conversion to audio. By default, the level meter bars and Lissajous

NOT PRESENT: Indicates that an audio bar is not present in the current audio input. For example, if a Dolby Digital input has a coding mode indicating a reduced number of channels.

DOLBY D, DOLBY D+, DOLBY E, DOLBY ED2: Indicates that the specified type of Dolby encoded audio is present on the channel or channels.

CLIP: Indicates the audio level was at the digital code for the maximum amplitude for ten consecutive samples.

OVER: Indicates when the audio amplitude (level) exceeds the silence level threshold for the specified duration. The default is -2dB for 1 second. To change the alarm settings, see [Configure Alarms](#).

Note: The 32-channel audio is supported with MP2-FMT-8K license. In 8K video with Quad 12G-SDI connection, the first 16 channels (of 32 channels) comes from the link A1 and the next 16 channels comes from the link B1. The two Audio applications must be selected in two tiles to display the 32-channel audio bars.

Lissajous Display

The Lissajous display is a visual of a user-specified pairing of channel inputs with a channel correlation meter.

Turn on the Lissajous display: In Aux Display, select **Lissajous**.

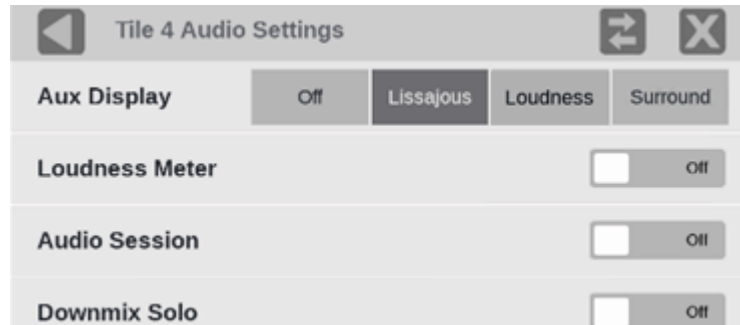

The Lissajous display appears to the right of the Audio bars.

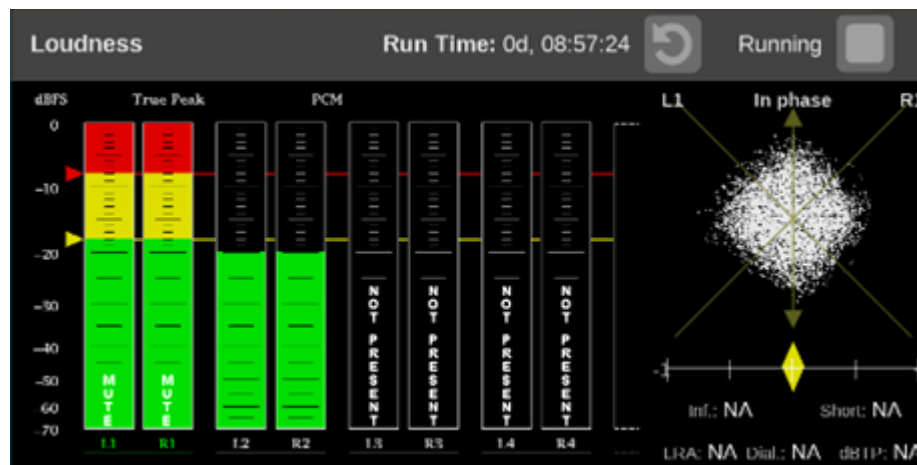

Loudness Display

The Loudness display is a visual of the audio loudness measurements. The Loudness display allows you to view audio loudness values associated with audio loudness measurements. This instrument maintains a running audio loudness session.

Note: The Loudness measurement is available for mono, stereo, 5.1, and 7.1 multi-channel audio programs.

Turn on the Loudness display: In Aux Display, select **Loudness**.

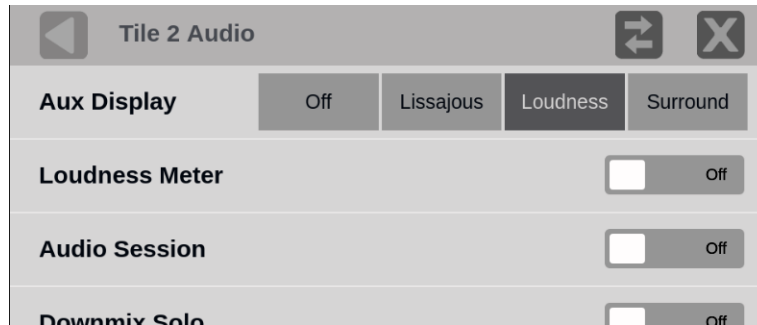

The Loudness Display appears to the right of the Audio bars.

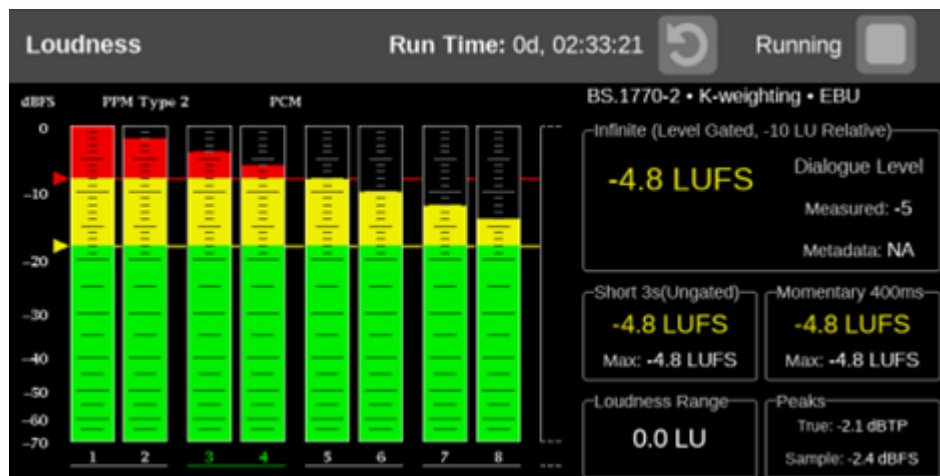

Note: The Audio tile appearance can vary based on the selection of other auxiliary audio displays, including Audio Session or Lissajous Display.

Configure the Loudness Display

1. Select the **Settings** icon (⚙️) to open the Settings menu.
2. Select **Audio** to open the Audio submenu.
3. Select **Loudness Settings**.

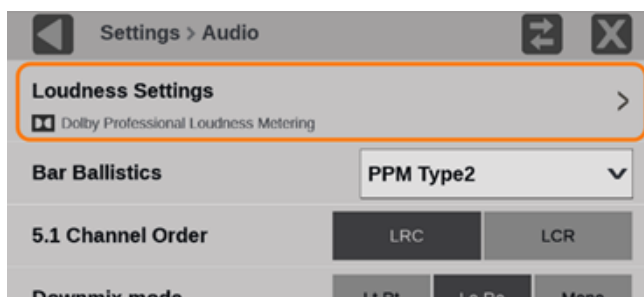

4. Load a standard:

- Select EBU R128:2014 or ATSC A/85:2014 for a pre-defined loudness metering configuration. Also changes the full-scale units between LUFS and LKFS according to the standard.
- Or customize the Loudness Display configuration according to the metering measurement goal or audio content type (dialogue, music, or movie). The Configuration Parameters for Loudness Display table shows the available configuration parameters.

Configuration Parameters for Loudness Display

Parameter	Available Configurations	Remarks
LOUDNESS METERING MODE	BS.1770-1 with DI ¹ , BS-1770-2 with DI, Leq(A) with DI, BS.1770-2 w/o DI	Modes implies a weighting function (A-weighting or K-weighting) and gating technique(s) when performing loudness metering
Speech Threshold (%)	0 to 100%	Threshold above which the Speech Gating is turned on in the DI enabled Metering modes.
Loudness Ballistics	Short Average, Long Average, EBU R128 M	Sets the response of the Loudness meter bar
TARGET LOUDNESS	0 to -31LKFS with 0 to 10LU tolerance	Sets the intended target loudness (to be highlighted in the Loudness display with appropriate color code)
LOUDNESS THRESHOLDS	Loud is 0 to -30 and Quiet 0 to -60 Full Scale Loudness	Sets the limits to trigger in-bar status for quiet and loud level.
Short-Term Gating Window	EBU R128 (3s), Legacy (10s)	Duration of the sliding windows for short-term loudness measurement
Full-Scale Units	LKFS or LUFS	Region specific selection; has no effect on measurement
TRUE PEAK DC Block and Emphasis Filter	Enable or Disable	DC Block simulates the effect of downstream devices that remove DC. The Emphasis Filter compensates for dispersion effects from Nyquist filters in the broadcast chain that make it difficult to measure and control the peak levels of high-frequency signals.

¹ Dialogue Intelligence enabled

Note: The dialogue intelligence algorithm in PRISM introduces a latency of 2.048s in the effective measurement of the short-term and infinite Loudness. Other Loudness measurement parameters are not affected by the latency.

Note: The Loudness measurements are updated every 500 ms in the user interface.

Note: Maximum short-term Loudness level can be considered as an alternative to using Loudness range for short audio clips.

Change Channels the Loudness Meter Measures

Select the correct program labels at the bottom of the level bars (green letters mean it is selected).

The Loudness meter measures the levels based on that audio program.

Note: Changing the selected Audio program that the Loudness meter measures changes the headphones or speaker pair, and changing the headphones or speaker pair changes the selected Audio program the Loudness meter measures. Changing the Audio program also resets the Loudness measurement.

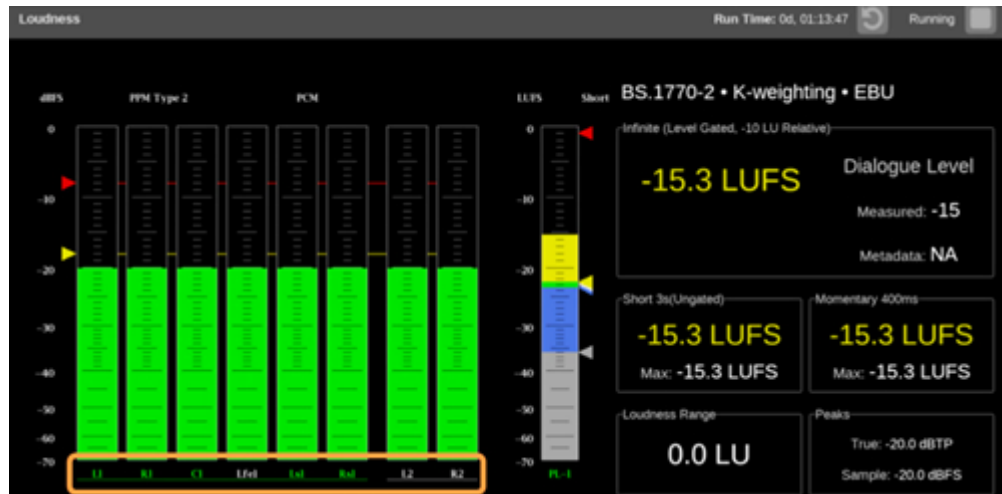

Note: The low-frequency effects channel (Lfe1) in 5.1 and 7.1 is not used in the loudness calculations.

Loudness Meter Labels

- The labels at the bottom of the audio bars (marked as 1) in this example means it is program 2 and there is a left and a right channel.

- The label at the bottom of the Loudness bar (marked as 2) means it is measuring program 2.
- The green letters in the status bar (marked as 3) mark the channels the Loudness display is measuring and where they are in the channel series.

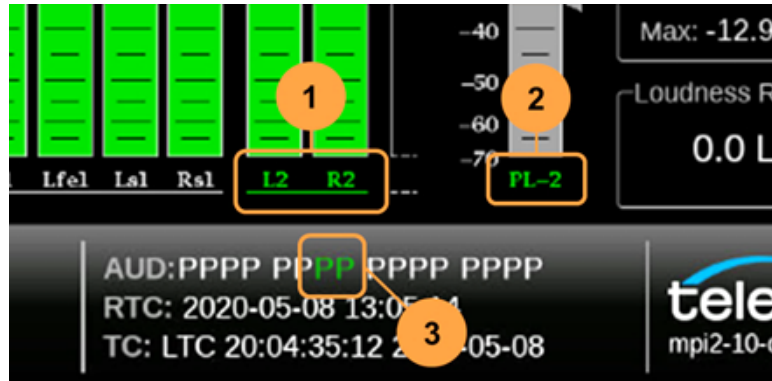

Loudness Meter Controls

- To start and stop the loudness meter: select the play (▶) or stop (◻) button.
- To reset the measurement run time: select the reset button (↺).

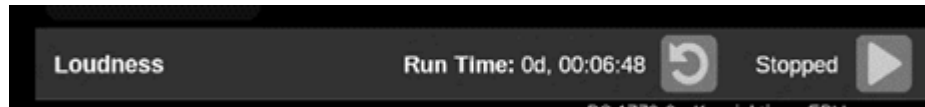

- The Audio Session and Loudness measurements can be independently stopped, started, and reset with the controls.



Surround Display

Turn on the Surround display:

1. In Aux Display, select **Surround**.

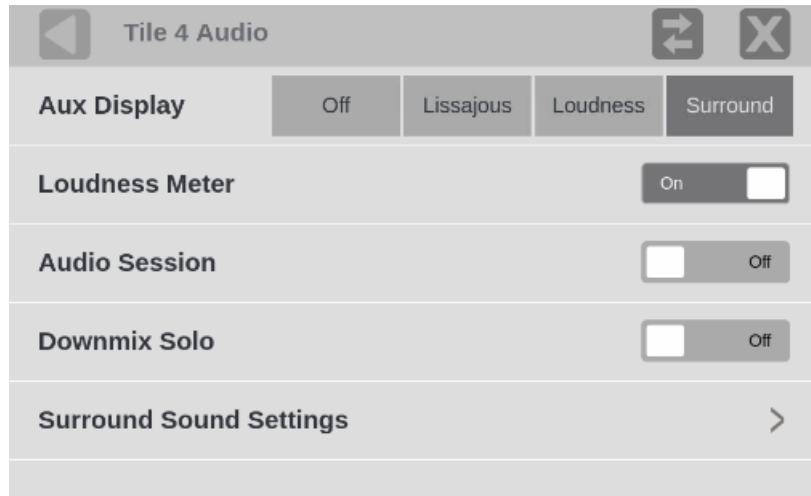

2. Turn on the Loudness Meter to monitor the loudness level, if needed; set the Loudness Meter to **On**.
3. Set the Loudness Metering to the type preferred.
 - A. Select the **Settings** icon () to open the Settings menu.
 - B. Select **Audio** and then select **Loudness Settings**.
 - C. Under LOUDNESS METERING MODE select from the four options:
 - ◆ BS.1770-1 plus Dialogue Intelligence
 - ◆ BS.1770-2 plus Dialogue Intelligence
 - ◆ BS.1770-2
 - ◆ Leq(A) plus Dialogue Intelligence

Note: A-weighting—Leq(A)—biases the response toward that of human hearing.

4. Set the surround settings:
 - A. In the Audio tile settings, select **Surround Sound Settings** to open the menu.
 - B. Select to view the lower level of audio (Main Bed), the top level of audio (Upper Bed), or the two together (Both).
 - C. Select to see the Phantom Source Indicator for the Main Bed or the Upper Bed.
 - D. If needed, set the Dominance Indicator to **On**.
 - E. If needed, set the Immersive Dominance Indicator to **On**.

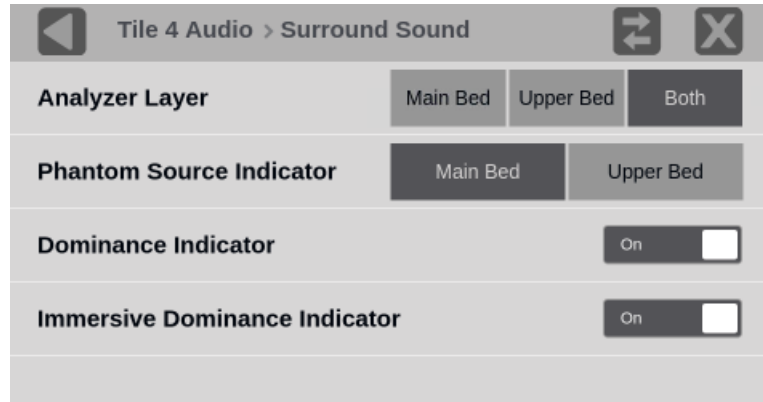

Surround Display Elements

Use the surround display to monitor relative loudness of the individual elements rendered in a surround-sound listening environment. Check the surround sound display for performance parameters and indicators.

5.1 Surround Sample

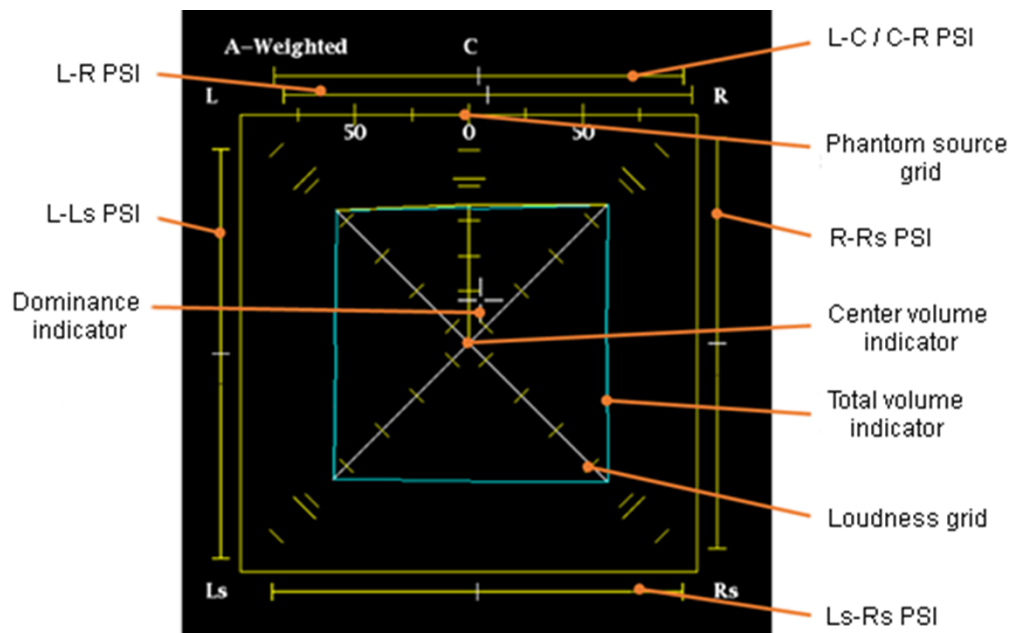

Note: The Audio Surround Sound display is provided under license from RTW GmbH & Co. KG.

The PSI (phantom sound indicator) bars are on each side of the surround sound display, the bars indicate the location of potential phantom sound sources formed by adjacent channels. The white tic marks on these moving bar indicators show the phantom source locations. The bar length indicates the correlation between the adjacent channels. A short-to-medium length green bar indicates positive correlation between the channels, forming a localized phantom sound source located at the white tic mark. The bar grows to full length and changes color to yellow as the correlation moves to zero, indicating a wide, non-localized sound image. The bar changes color to red for adjacent channels with significant negative correlation. For negative correlations, the ends of the PSI for the L and R channels continue to grow at a 45° angle while the other PSIs remain at full length.

L-R PSI: Left-to-right phantom sound indicator bar

L-Ls PSI: Left-to-left surround phantom sound indicator bar

Dominance indicator: Shows the position of the subjectively perceived acoustic focal point.

L-C / C-R PSI: Left-to-center and center-to-right phantom sound indicator bar

Phantom source grid: A measurement of 50 is the center of the left-to-center or center-to-right scales.

R-Rs PSI: Right-to-right surround phantom sound indicator bar

Center volume indicator: This displays the sound volume of the center channel as a vertical yellow bar between the L and R channels, and connects the ends of the L, C, and R audio level indicators with straight lines.

Total volume indicator: This is the cyan polygon formed by connecting the level indicator end points, showing the total sound volume of the L, R, Ls, and Rs channels. Each connecting line bends away from the center if the two signals have a positive correlation, bends toward the center if the signals have a negative correlation, and do not bend if the signals are uncorrelated.

Loudness grid: This is the ruled scale, radiating from the center, on which the level indicators register their audio level and balance. The scale has tic marks at 10 dB intervals. An additional tic mark indicates the -18 dB level. The -18 dB and -20 dB levels are typically used for aligning audio levels.

Ls-Rs PSI: Left surround-to-right surround phantom sound indicator bar

7.1.4 Surround (Main Bed) Sample

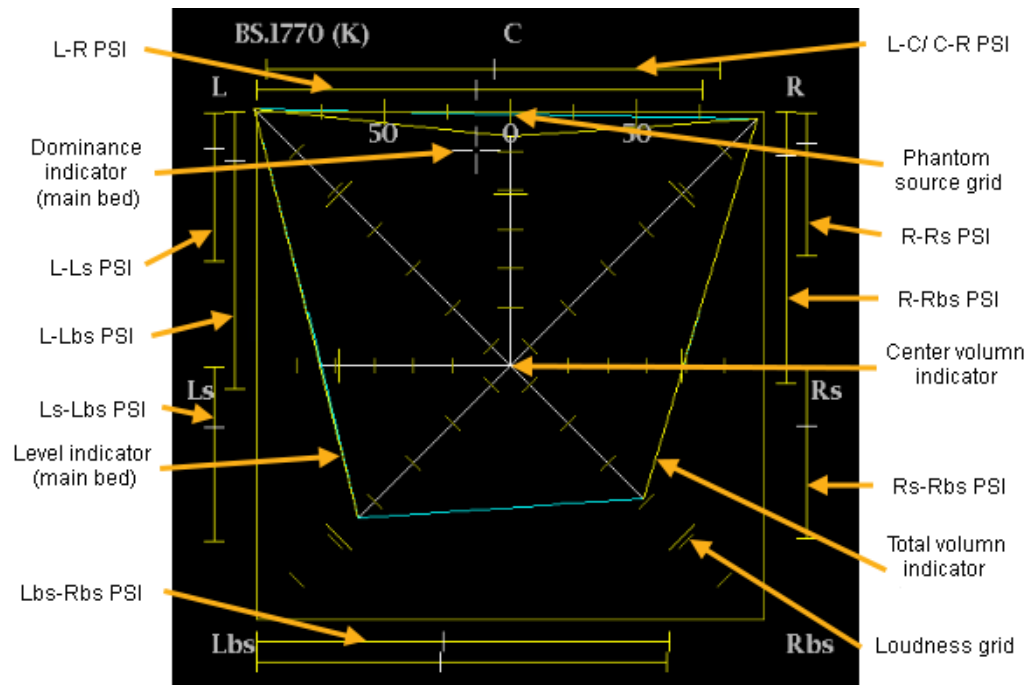

The PSI (phantom sound indicator) bars are on each side of the surround sound display, the bars indicate the location of potential phantom sound sources formed by adjacent channels. The white tic marks on these moving bar indicators show the phantom source locations. The bar length indicates the correlation between the adjacent channels. A short-to-medium length green bar indicates positive correlation between the channels, forming a localized phantom sound source located at the white tic mark. The bar grows to full length and changes color to yellow as the correlation moves to zero, indicating a wide, non-localized sound image. The bar changes color to red for adjacent channels with significant negative correlation. For negative correlations, the ends of the PSI for the L and R channels continue to grow at a 45° angle while the other PSIs remain at full length.

L-R PSI: Left-to-right phantom sound indicator bar

Dominance indicator (main bed): Shows the position of the subjectively perceived acoustic focal point. The white crosshair is specifically for the main bed data.

L-Ls PSI: Left-to-left surround phantom sound indicator bar

L-Lbs PSI: Left-to-left back surround phantom sound indicator bar

Ls-Lbs PSI: Left surround-to-left back surround phantom sound indicator bar

Level indicator (main bed): Shows the position of the subjectively perceived acoustic focal point for the main bed of audio data.

Rbs-Lbs PSI: Right back surround-to-left back surround phantom sound indicator bar

L-C / C-R PSI: Left-to-center and center-to-right phantom sound indicator bar

Phantom source grid: A measurement of 50 is the center of the left-to-center or center-to-right scales.

R-Rs PSI: Right-to-right surround phantom sound indicator bar

R-Rbs PSI: Left-to-left back surround phantom sound indicator bar

Center volume indicator: This displays the sound volume of the center channel as a vertical yellow bar between the L and R channels, and connects the ends of the L, C, and R audio level indicators with straight lines.

Rs-Rbs PSI: Left surround-to-left back surround phantom sound indicator bar

Total volume indicator: This is the cyan polygon formed by connecting the level indicator end points, showing the total sound volume of the L, R, Ls, and Rs channels. Each connecting line bends away from the center if the two signals have a positive correlation, bends toward the center if the signals have a negative correlation, and do not bend if the signals are uncorrelated.

Loudness grid: This is the ruled scale, radiating from the center, on which the level indicators register their audio level and balance. The scale has tic marks at 10 dB intervals. An additional tic mark indicates the -18 dB level. The -18 dB and -20 dB levels are typically used for aligning audio levels.

7.1.4 Surround (Upper Bed) Sample

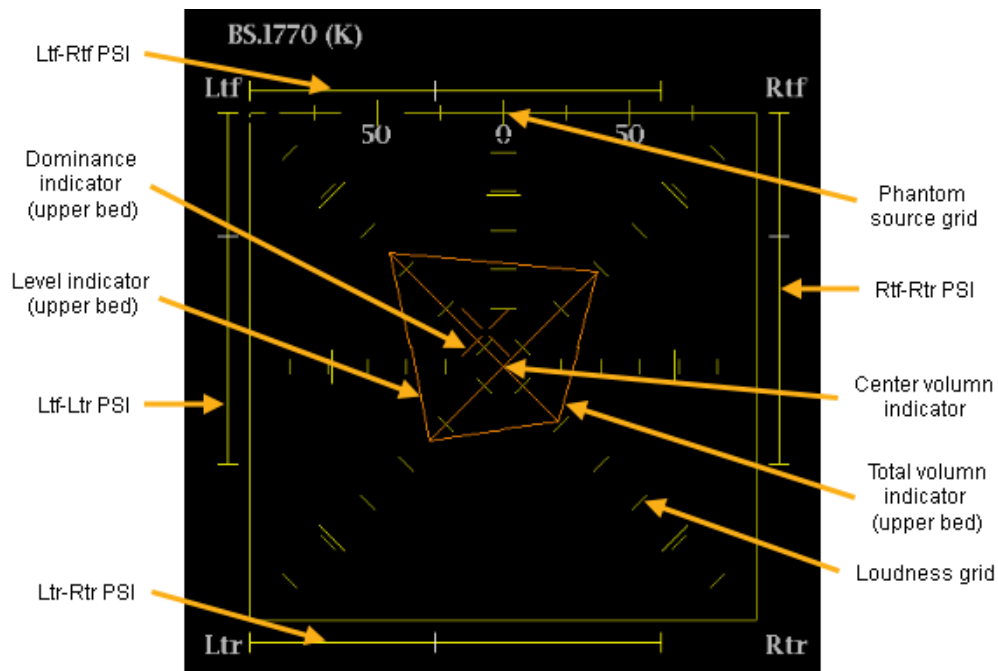

Note: If in the Analyzer Layer, the Upper Bed layer (or Both) is selected, but there is no upper bed data, as in non-immersive surround programs like 5.1 or 7.1, the upper bed surround display will be empty (no orange display) because there is no upper bed audio data.

The PSI (phantom sound indicator) bars are on each side of the surround sound display, the bars indicate the location of potential phantom sound sources formed by adjacent channels. The white tic marks on these moving bar indicators show the phantom source locations. The bar length indicates the correlation between the adjacent channels. A short-to-medium length green bar indicates positive correlation between the channels, forming a localized phantom sound source located at the white tic mark. The bar grows to full length and changes color to yellow as the correlation moves to zero, indicating a wide, non-localized sound image. The bar changes color to red for adjacent channels with significant negative correlation. For negative correlations, the ends of the PSI for the L and R channels continue to grow at a 45° angle while the other PSIs remain at full length.

Ltf-Rtf PSI: Left top front-to-right top front phantom sound indicator bar

Dominance indicator (upper bed): Shows the position of the subjectively perceived acoustic focal point. The orange crosshair is specifically for the main bed data.

Level indicator (upper bed): Shows the position of the subjectively perceived acoustic focal point for the upper bed of audio data.

Ltf-Ltr PSI: Left top front-to-Left top rear surround phantom sound indicator bar

Ltr-Ltr PSI: Left top rear-to-Right top rear surround phantom sound indicator bar

Phantom source grid: A measurement of 50 is the center of the left-to-center or center-to-right scales.

Rtf-Rtr PSI: Right top front-to-Right top rear surround phantom sound indicator bar

Center volume indicator: This displays the sound volume of the center channel as a vertical yellow bar between the L and R channels, and connects the ends of the L, C, and R audio level indicators with straight lines.

Total volume indicator (upper bed): This is the orange polygon formed by connecting the level indicator end points, showing the total sound volume of the L, R, Ls, and Rs channels. Each connecting line bends away from the center if the two signals have a positive correlation, bends toward the center if the signals have a negative correlation, and do not bend if the signals are uncorrelated.

Loudness grid: This is the ruled scale, radiating from the center, on which the level indicators register their audio level and balance. The scale has tic marks at 10 dB intervals. An additional tic mark indicates the -18 dB level. The -18 dB and -20 dB levels are typically used for aligning audio levels.

7.1.4 Surround (Both Beds) Sample

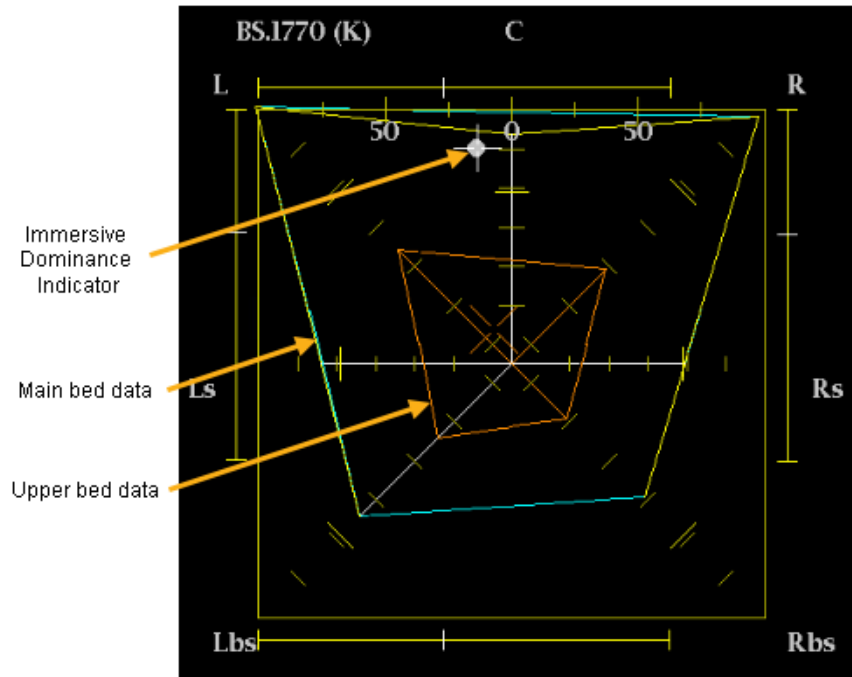

Note: If in the Analyzer Layer, the Both layer is selected, but there is no upper bed data, as in non-immersive surround programs like 5.1, or 7.1, the upper bed surround display will be empty (no orange display) because there is no upper bed audio data.

Immersive Dominance Indicator: Shows the position of the subjectively perceived acoustic focal point of all data. The dot is only visible when both beds are shown.

Main bed data: For details of the display, see [7.1.4 Surround \(Main Bed\) Sample](#).

Upper bed data: For details of the display, see [7.1.4 Surround \(Upper Bed\) Sample](#).

Surround Display Usage Notes

The displays shown here are examples of how the surround sound waveform appears for some typical 5.1 surround signals. Similar principles apply to 7.1 signals, and to 5.1.4 and 7.1.4 main bed and upper bed signals.

Example 1: Shows uncorrelated signals with the same level in the L, C, R, Ls, and Rs channels.

Note: PSI are yellow showing uncorrelated audio between the channels.

Example 2: Shows a sine wave test tone with the same level in the L,C, R, Ls, and Rs channels. All signals are in phase, creating white marks for the phantom source indicators mean that each channel has the same amplitude and frequency.

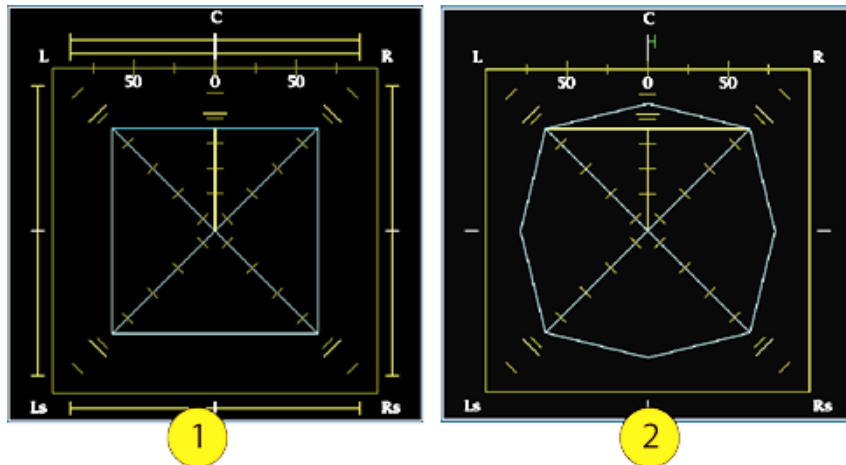

Example 3: This is the same as example 2, with the exception that Channel L is out of phase.

Note: The PSIs are in red for L-R, L-Ls, and L-C.

Example 4: Shows the surround sound program with strong center-channel presence, typically from high dialogue audio levels compared to other channels.

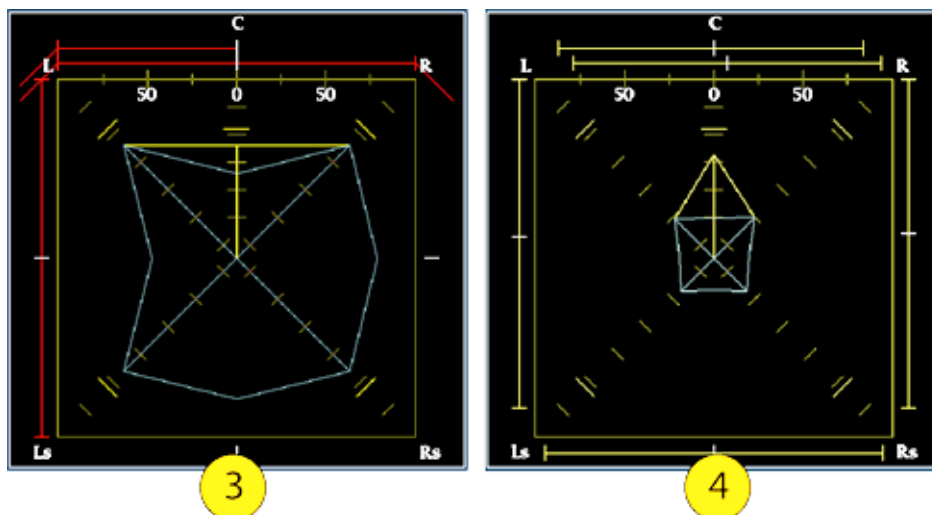

Example 5: Shows a surround sound program with weak center-channel presence, likely with a lower dialogue level compared to other channels.

Example 6: Shows a monaural signal in channels Ls and Rs, creating a phantom source in the center, as in a 5.1 surround sound system. Typically a mix could contain a copy of the L and R channel at a lower level in the Ls-Rs to create a pseudo surround mix. The white marks mean a monaural channel for Ls and Rs. The other channels are uncorrelated.

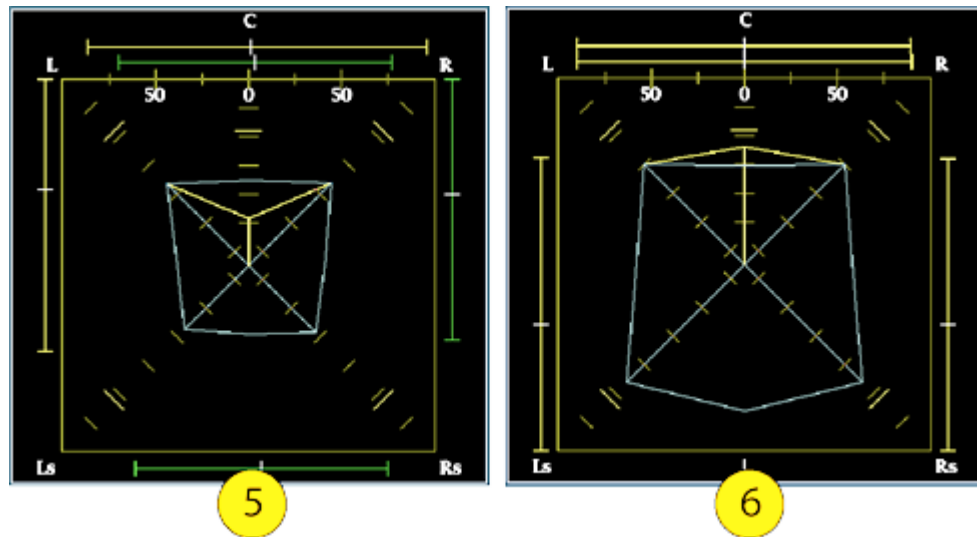

Loudness Meter

It is a part of the Audio application in PRISM and it is configured in the main Settings menu. The Audio Loudness Meter allows you to view audio loudness values associated with audio loudness measurements. This instrument maintains a running audio loudness session.

Turn on the audio loudness values: Set Loudness Meter to **On**.

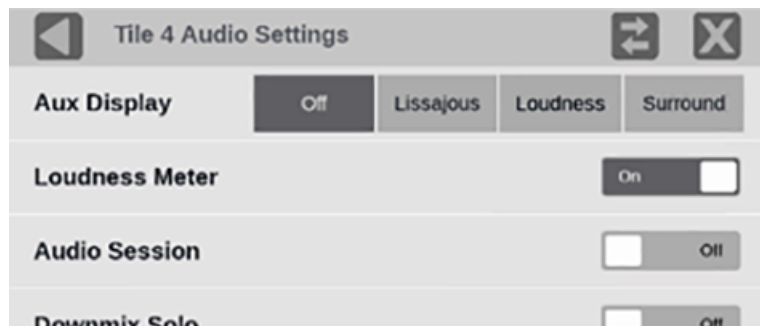

The Loudness Meter appears to the right of the Audio bars.

Note: Loudness measurements are not supported for more than 8 channels, so the Loudness Meter does not function with 5.1.4 or 7.1.4 programs.

Note: PRISM supports Audio Loudness Alarms. Changing the active audio program will reset the Infinite Loudness measurements. So you must stop the Loudness measurements in the audio application if you want to listen to the audio output, or measure the loudness of a different audio program.

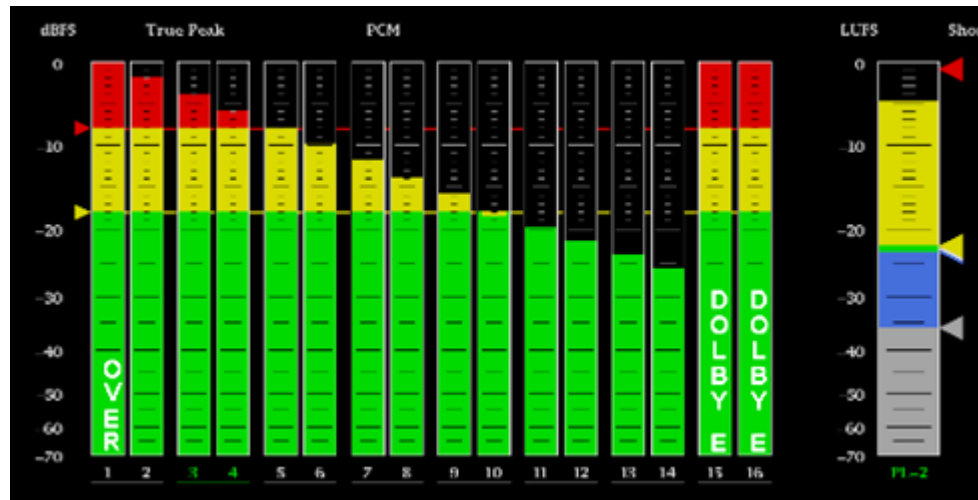

Audio Session

This consists of several performance parameters for an overview of the audio input signal.

Turn on the audio signal overview: Set Audio Session to **On**.

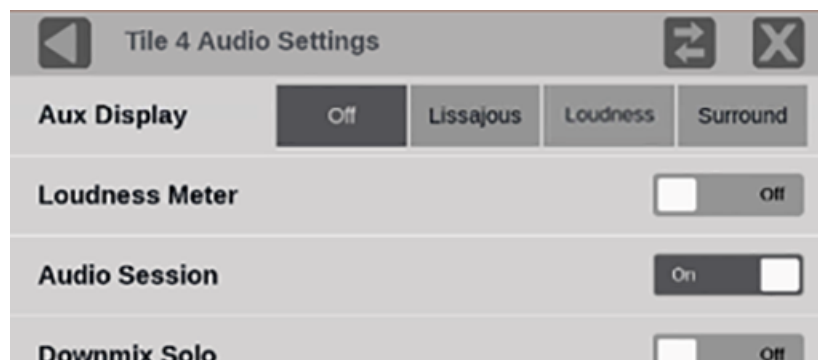

The Audio Session appears below the audio bars.



Downmix Solo

It allows you to select any one channel of a downmixed 5.1 or 7.1 stream and listen to it separately. This helps to isolate and identify an unexpected noise in a stream.

To use Downmix Solo:

Note: If you have an original MPI or MPX upgraded with a 25 Gb media board, see [Access Downmix Control for Input 2110-30 with Multiple Audio Streams](#) to set up the instrument for downmix.

1. Turn on Downmix Solo: In the Audio Settings, set Downmix Solo to **On**.

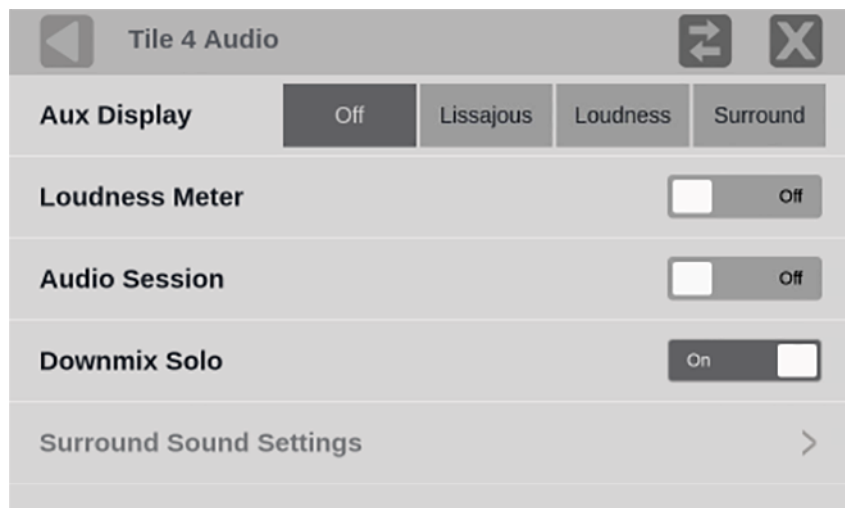

2. Select the **Volume** icon () in the Status bar to open the volume controls.

3. In the volume controls, select the **downmix** button.

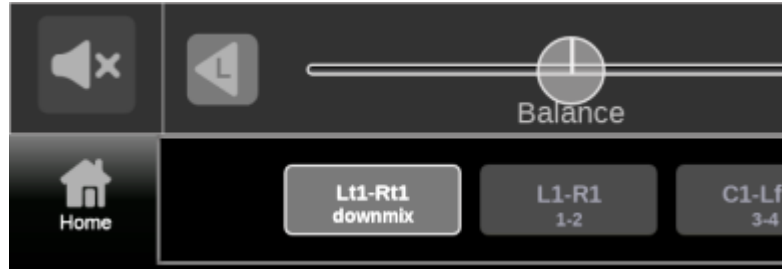

4. Select the **Home** icon (🏠) to close the volume controls.

5. Select a channel to isolate in the Audio application:

- To change the solo channel, select another channel in the downmixed stream.
- To return to the entire downmixed stream (without turning Downmix Solo off), select the highlighted channel again.

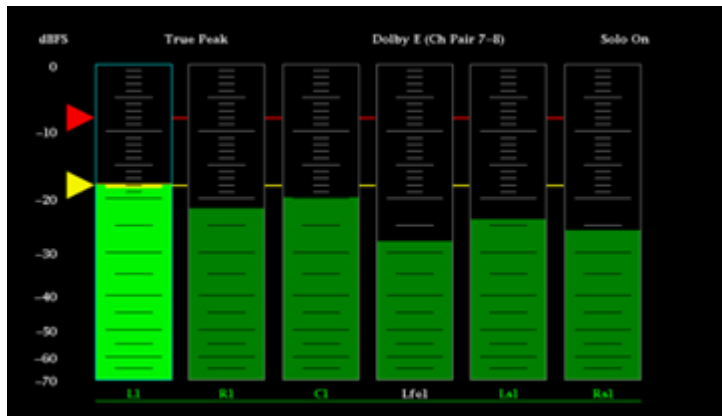

Dolby Status Application

Note: In multi-input mode, Dolby Status only works with the primary channel.

Dolby Status supports all Dolby metadata for the currently monitored input can be viewed in the Dolby Status application. The application tile indicates if Dolby audio is not available in the currently monitored input.

Note: The Dolby Status application requires software options MP2-AUD or MP2-DLBY.

If the instrument has Dolby monitoring capabilities, it can decode and monitor audio signals that are based on Dolby digital surround sound formats. These formats are Dolby D (AC-3)/D Plus (E-AC-3) compression (designed for distribution) and Dolby E compression (designed for production).

To refresh the Dolby Status data, select the Refresh icon (🔄) at the top of the Dolby Status tile.

If information in the Dolby Status page should have updated, but has not, for example the Program Desc Text has not updated, the Refresh icon will reload the data.

The sample shows Dolby D data.

Dolby Status		Program 1	
Dolby Format	Dolby D	Dolby Surround Mode	Unknown
Channel Mode	3/2 L	Copyright Bit	Yes
Metadata Source	AES Embedded 9-10	Original Bitstream	Yes
Dolby Data Rate	384 kbps		
Bitstream Mode	Complete Main		
Dolby Sample Rate	48 kHz		
DYNAMIC RANGE PARAMETERS		EXTENDED BSI	
Dialogue Level	-23 dB	Preferred Stereo Dmix	Not Indicated
Program Loudness		Lt/Rt Center Mix Lvl	-3 dB
Average Loudness		Lt/Rt Surrnd Mix Lvl	-3 dB
Line Mode Cmpr	Unknown	Lo/Ro Center Mix Lvl	-3 dB
RF Mode Cmpr	-0.28 dB	Lo/Ro Surrnd Mix Lvl	-3 dB
		Surround EX Mode	No
RF Overmod Prot	Disabled	Headphone Mode	Unknown
Center Mix Lvl	-3 dB	A/D Converter Type	STD
Surround Mix Lvl	-3 dB		
Mixing Level	105.00 dB	SMPTE Timecode	00:00:00:00
Room Type	Small Room		

This sample shows Dolby E data with the external reference measurement.

Dolby Status Program 1			
Program Desc Text	Tektronix Program 1		
Dolby Format	Dolby E 20	Dolby Surround Mode	Not Indicated
Channel Mode	3/2 L	Copyright Bit	No
Program Config	5.1	Original Bitstream	Yes
Metadata Source	AES Embedded 1-2	DC Filter	No
Dolby Data Rate	Not specified	Lowpass Filter	No
Bitstream Mode	Complete Main	LFE Lowpass Filter	No
Dolby E Frame Rate	25 fps	Surround 3 dB Atten	No
Dolby E Frame Loc	L42 F1 s1937	Surround Phase Shift	No
Ext Ref Guardband	L28 F1 s587		
DYNAMIC RANGE PARAMETERS		EXTENDED BSI	
Dialogue Level	-23 dB	Preferred Stereo Dmix	Lo/Ro
Program Loudness		Lt/Rt Center Mix Lvl	-3 dB
Average Loudness		Lt/Rt Surrnd Mix Lvl	-3 dB
Line Mode Cmpr	Film Standard	Lo/Ro Center Mix Lvl	-3 dB
RF Mode Cmpr	Film Standard	Lo/Ro Surrnd Mix Lvl	-3 dB
RF Overmod Prot	Disabled	Surround EX Mode	Not Indicated
Center Mix Lvl	-3 dB	Headphone Mode	Not Indicated
Surround Mix Lvl	-3 dB	A/D Converter Type	STD
Mixing Level	Not Indicated	SMPTE Timecode	15:00:00:00

This sample shows Dolby ED2 data with a Presentation option (in the upper right corner) selected.

Note: All Presentation titles are user selected. They can be changed to refer to the related information as needed.

Dolby Status Presentation 5.1 Plus 3D				
Dolby E Pair 1(1-2)	Dolby E Pair 2(3-4)	Dolby ED2	Dolby Timing	
Evolution Pair 1(1-2)			Present	
Evolution Pair 2(3-4)			Present	
PRESENTATION NAME : 5.1 Plus 3D				
Objects	Presented	Presented	Presented	Presented
Type	Bed	Dynamic	Dynamic	Dynamic
Category	-	Generic	Generic	Generic
Index	-	1	2	3
Config	5.1	1.0	1.0	1.0
Position X	-	0	1	0.5
Position Y	-	0	0	1
Position Z	-	1	1	1

This sample shows Dolby Timing.

Dolby Status		Program 1
Dolby E Pair 1(1-2)	Dolby E Pair 2(3-4)	Dolby Timing
Dolby E Frame Loc Pair 1(1-2)		L21 F1 s1937
Dolby E Frame Loc Pair 2(3-4)		L21 F1 s1945
Ext Ref Guardband Pair 1(1-2)		L328 F2 s772
Ext Ref Guardband Pair 2(3-4)		L328 F2 s773

Dolby Status Settings Menu

Open the Dolby Status Settings menu:

1. Select the **Tiles** icon (🧩).
2. Select the tile with the Dolby Status application.
3. Select the **Tile** icon (⚙️).

Note: The Move icon (↔️) is in the settings menu header. Select this icon to move the settings left or right.

Title 1 Dolby Status Settings

Metadata Source: **AUTO** | AES | VANC

VANC SETTINGS (ST 2020)

DID: (69) 0x45

SDID: (5) 0x5

Dolby Program: 1

Metadata Source

Lets you select the source of the Dolby E metadata, either from the incoming Dolby E audio, if your instrument is decoding Dolby E audio, or VANC metadata if the Dolby E is externally decoded.

Auto: Selects the Dolby E audio by default as the metadata source, if it is available. If Dolby E audio is not available, it uses VANC audio.

AES: Selects the Dolby E audio as the metadata source. The Dolby Status application is blank if Dolby E is not being decoded.

VANC: Selects VANC as the metadata source. The SDID must be properly selected.

DID

Data identifier of the requested packet, it is set to 0x45 (69 decimal) and is not changeable.

SDID

Secondary Data Identifier of the requested packet, an SDID value of 01h is used when there is only one audio program associated with a video signal, and there is no intended association between VANC packets with an SDID value of 01h and a specific audio channel pair.

Association between the first audio channel pair of an audio program and the SDID values

Audio Channel Pair	SDID
No association	01h
Channel pair 1/2	02h
Channel pair 3/4	03h
Channel pair 5/6	04h
Channel pair 7/8	05h
Channel pair 9/10	06h
Channel pair 11/12	07h
Channel pair 13/14	08h
Channel pair 15/16	09h

When multiple audio programs are carried by, or associated with, a single video signal, the SDID value is used to identify the VANC data packets carrying the audio metadata for each of the audio programs.

The audio channels making up an audio program are assigned to consecutively numbered or consecutively arranged audio channel pairs. The VANC packets carrying the audio metadata for a specific audio program are identified by setting the SDID values of these packets to the value associated with the lowest numbered audio channel pair of the group of audio channel pairs carrying the complete audio program.

For example, if there is a six-channel program carried in the first three audio channel pairs and a stereo program carried by the fourth audio channel pair, then the VANC packets carrying the metadata for the six-channel program would have their SDID value set to 02h because the program starts in audio channel pair 1/2. The VANC packets carrying the metadata for the stereo program would have their SDID value set to 05h because the stereo program starts in audio channel pair 7/8.

Dolby Program

Select the Dolby Program menu to choose the Dolby program number to monitor.

The Program number in the top right of the Dolby Status application border is the same as the Dolby Program number in the Dolby Status Settings. Select the arrow and select the number of the program to monitor.

Elements of Dolby D/D Plus/E Status Display

This is a description of some of the elements that appear in the Dolby Status application for Dolby D, D Plus, or E. For a complete list of the elements that might appear, see the Dolby Metadata Guide at the Dolby website.

Program Desc Text

A 32-character ASCII text field used by the program author to describe the audio program; for example, the name of the program (Movie Channel Promo), the program source (Football Main Feed), or the program language (Danish).

Dolby Format

Indicates the Dolby Format. This indicator is also tied to the Dolby Format Error/Alarm: if the Alarm is asserted, the Dolby Format is displayed in red.

Channel Mode (or Audio Coding Mode)

Indicates the active channels within the encoded bit stream, representing it in a ratio, X/Y, where X is the number of front channels (Left, Center, Right) and Y is the number of rear (Surround) channels. If the LFE Channel is present, an L is added at the end of the channel mode.

Program Config

Determines how the audio channels are grouped in a Dolby E bitstream. Up to eight channels can be grouped together in individual programs, where each program contains its own metadata.

Metadata Source

Indicates the input from which the Dolby Content is sourced.

Dolby Data Rate

For Dolby E it indicates the data rate that would be used to encode a Dolby Digital bitstream.

Bitstream Mode

Describes the audio service contained in the Dolby Digital bitstream. A complete audio program may consist of a main audio service (a complete mix of all the program audio), an associated audio service comprising a complete mix, or a main service combined with an associated service. For more information about possible values, see the instrument online help; when the Dolby Status display is active in a tile, select the HELP button.

Dolby E Frame Rate

Displays the frame rate of the Dolby E audio. If Dolby Frame Rate is not the same as the video Frame Rate, the rate value is displayed in red.

Dolby E Frame Loc

Displays the location (line number and sample number) of the ST 337 preamble.

Dolby ExtRef Guardband

Displays the location (line number and sample number) of the corresponding Blackburst reference that aligns with the ST 337 preamble.

Dialogue Level

Represents the long-term, A-weighted average level of dialog within a presentation, Leq(A).

Elements of Dolby ED2 Status Display

This is a description of some of the elements that appear in the Dolby Status application for Dolby ED2. For a complete list of the elements that might appear, see the Dolby Metadata Guide at the Dolby website.

Dolby E(Pair 1) 1-2 and Dolby E(Pair 1) 3-4

These tabs in the Dolby Status tile have most of the same elements as the Dolby D, D Plus, and E data. For more details, see [Elements of Dolby D/D Plus/E Status Display](#).

Dolby ED2

This tab in the Dolby Status Tile has these elements:

Evolution pair 1(1-2) and Evolution pair 2(3-4)

Describes the status of the channel pairs (in parentheses) of the ED2 transport.

Type

This is the audio object type, such as Bed or Dynamic.

Index

This is the object number starting after the Audio Bed.

Position X, Position Y, Position Z

This positional metadata describes the audio objects in the bitstream.

Dolby Timing

This tab in the Dolby Status Tile has these elements:

Dolby E Frame Loc (pair 1) and Dolby E Frame Loc (pair 2)

Displays the line, field, and sample numbers of the of the corresponding video of the Dolby ED2 preamble.

Ext Ref Guardband (pair 1) and Ext Ref Guardband (pair 2)

Displays the line, field, and sample number of the corresponding Blackburst reference that aligns with the Dolby E preamble location. Make sure the Dolby E preamble location stays in field 1 of the reference signal. If it stays in field2 of the reference, the Dolby E stream might corrupt at signal switching.

Before checking this measurement, make sure that Analog or PTP is selected (in Setting and then the Reference menu) and the incoming signal is locked to a reference signal on the status bar.

AES Channel Status Application

Note: In multi-input mode, AES Channel Status only works with the primary channel.

The AES Channel Status application provides detailed data for each audio channel in the monitored signal, up to 16 channels total. It is only available for SDI.

The data is presented by channel in transport order, regardless of how the Audio application maps or configures the channels.

AES Channel Status								PPPP PPPP PPPP PPPP
Field Name	CHL(1)	CHR(2)	CHL(3)	CHR(4)	CHL(5)	CHR(6)	CHL(7)	
Channel Use	Professional	Professional	Professional	Professional	Professional	Professional	Professional	
Linear PCM Ident	PCM	PCM	PCM	PCM	PCM	PCM	PCM	
Emphasis	No Emphasis	No Emphasis	No Emphasis	No Emphasis	No Emphasis	No Emphasis	No Emphasis	
Locking of Source	Locked	Locked	Locked	Locked	Locked	Locked	Locked	
Sample Frequency	48 KHz	48 KHz	48 KHz	48 KHz	48 KHz	48 KHz	48 KHz	
Channel Mode	2 Channel	2 Channel	2 Channel	2 Channel	2 Channel	2 Channel	2 Channel	
User Bits Mode	192 bit block	192 bit block	192 bit block	192 bit block	192 bit block	192 bit block	192 bit block	
AUX Bits Use	Main Audio	Main Audio	Main Audio	Main Audio	Main Audio	Main Audio	Main Audio	
Audio Word Length	24/24	24/24	24/24	24/24	24/24	24/24	24/24	
Alignment Level	Not Indicated	Not Indicated	Not Indicated	Not Indicated	Not Indicated	Not Indicated	Not Indicated	
Reference Signal	Not a ref	Not a ref	Not a ref	Not a ref	Not a ref	Not a ref	Not a ref	
Origin	A1-1	A1-2	A1-3	A1-4	A2-1	A2-2	A2-3	
Destination								
Sample Number	0	0	0	0	0	0	0	
Time of Day	00:00:00:00000	00:00:00:00000	00:00:00:00000	00:00:00:00000	00:00:00:00000	00:00:00:00000	00:00:00:00000	

Note: Only Professional mode (in Channel Use) is available.

Note: If the two Block CRC lines (*should be* and *computed*) do not match, the Block CRC (*computed*) line turns red as a warning that the numbers are mismatched and a CRC error has happened.

Time of Day	00:00:00:00000	00:00:00:00000	00:00:00:00000	00:00:00:00000	00:00:00:00000
Block CRC (should be)	01001100	01100110	10101111	00110010	10011001
Block CRC (computed)	01001100 Ok	01100110 Ok	10101111 Ok	00110010 Ok	10011001 Ok

Event Log Application

The Event Log application provides a view of detected errors. The display buffer for the application shows 1,000 log entries.

Note: To see all of the available columns (Notes and Date), set the application to full-screen.

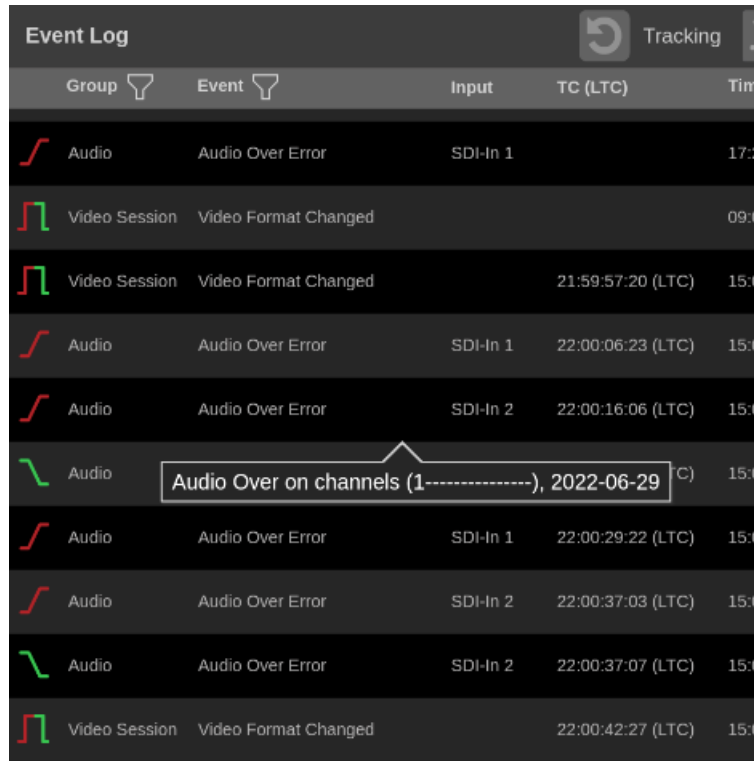

Elements of Event Log Display

Reset icon: Select the Reset icon (↺) to hide all log items, so only new log items are displayed. Select **Undo Reset** in the settings menu to show the log items that were hidden by pressing Reset.

Track icon: The Track icon (▶) and the text “Tracking” to the left mean the Event Log is tracking new events. The newest events appear at the bottom of the Event Log.



Scroll in the Event Log list or select-and-hold the control and drag it to a previous event. Tracking new events is automatically paused.

Pause icon: The Pause icon (⏸) and the text “Paused” means the Event Log is not tracking new events. Select the Pause icon to return to tracking new events. The Error Log is also divided into columns:

Group	Event	TC (LTC)	Date	Time
Video Session	SDI Framer CRC error	22:25:24:19 (LTC)	2021-02-24	14:26:24
Video Session	SDI SAV placement error	22:25:24:19 (LTC)	2021-02-24	14:26:24
Video Session	SDI SAV placement error	22:25:24:19 (LTC)	2021-02-24	14:26:24

The Error Log is divided into columns:

Group: Lists the group the event is related to and shows the current state of the log entries:

- Red-rising edge (↗) items are detected errors.
- Green-falling edge (↘) items are errors that have cleared.
- Red and green-rising and falling edge (↕) items indicate a momentary error that was in error condition but is now in normal condition. The PTP or TC field is blank when the selected time source is not available.
- White items are informational and identify a change in instrument state.

Event: Lists the title of the error.

PTP (UTC) or TC (LTC): Shows the time, in the mode chosen by the user, the error occurred.

Date: Shows the date, according to the internal clock, that the error occurred in the form YYYY-MM-DD.

Time: Shows the time, according to the internal clock, that the error occurred in the form HH:MM:SS.

Event Log Settings Menu

Open the Event Log Settings menu:

1. Select the **Tiles** icon (⌘).
2. Select the tile with the Event Log application.

3. Select the **Tile** icon (⚙️).

Note: The Move icon (↔️) is in the settings menu header. Select this icon to move the settings left or right.

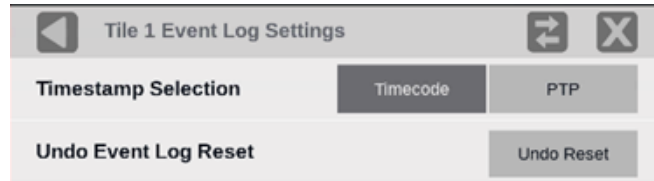

Timestamp Selection

- Select **Timecode** to set TC (LTC) or TC (VITC) for error tracking in the Event Log.

Configure TC (LTC) or TC (VITC):

- A. Select the **Settings** icon (⚙️), then select **Anc Data**.
- B. In Timecode Format select LTC or VITC.

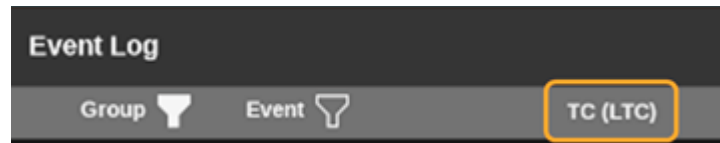

- Select **PTP** to set PTP (UTC) for error tracking in the Event Log.

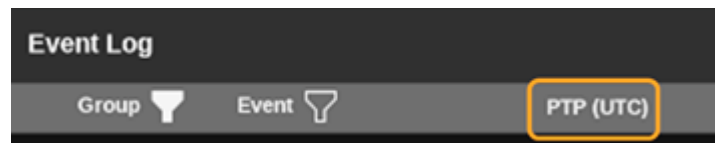

Undo Event Log Reset

Select **Undo Reset** to cancel the last reset of the logged events.

Filter Event Log Events

This section explains the several ways to sort logged events.

Filter by Group

- To open the group filter, select the **Group** heading.

Note: If there is any other filter applied (Event, Date, Time—marked by a full filter icon (🔍) next to a heading), it limits what any other filter shows. For example, if no events are selected in the Event filter, then no errors appear even if all the groups are selected.



- To move the menu to a location, select-and-hold anywhere in the menu and move it.
- To select all checkboxes (see all errors), or unselect all (hide all errors), select the All Groups checkbox. The Event Log immediately adds or removes errors from the list.
 - If all groups are selected (no filter), the Group filter icon is empty.

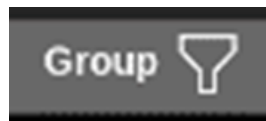

- If any group is not selected (a filter is applied), the Group filter icon is full.



- To select or remove the check from any single checkbox, select anywhere in the title line.

Filter by Event

- To open the event filter, select the **Event** heading.

Note: If there is any other filter applied (Group, Date, Time—marked by a filled filter icon——next to a tile), it limits what any other filter shows. For example, if no groups are selected in the Group filter, then no errors appear even if all the events are selected.

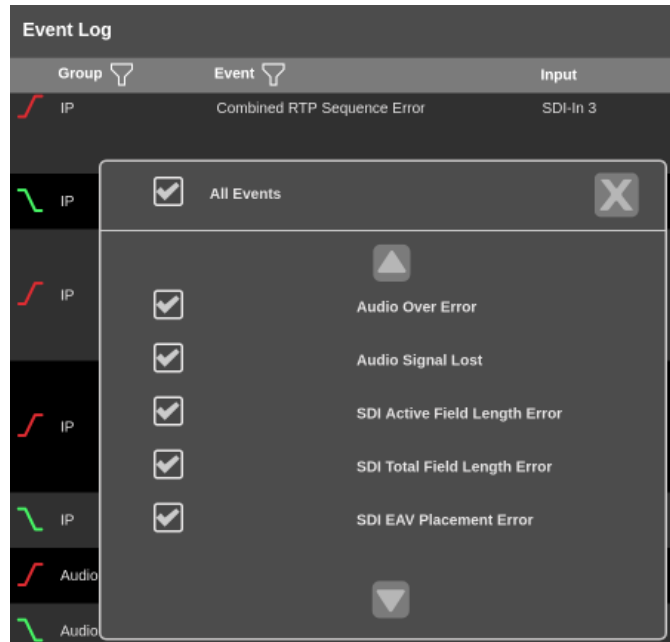

- To move the menu to a location, select-and-hold anywhere in the menu and move it.
- To select all checkboxes (see all errors), or remove all checks (hide all errors), select the All Events checkbox. The Event Log immediately adds or removes errors from the list.
 - If all groups are selected (no filter), the filter icon is empty.



- If any group is not selected (a filter is applied), the filter icon is full.



- To select or remove the check from any single checkbox, select anywhere in the line of the title.
- To scroll through the list of events, select the arrows at the top and bottom of the menu.

Filter by Date or Time

- To open the Date and Time filter, select either the Date or Time heading. Both open the same menu.

Note: If there is any other filter applied (Group, Event—marked by a filled filter icon——next to a tile), it limits what any other filter shows. For example, if no groups are selected in the Group filter, then no errors appear even if all the events are selected.

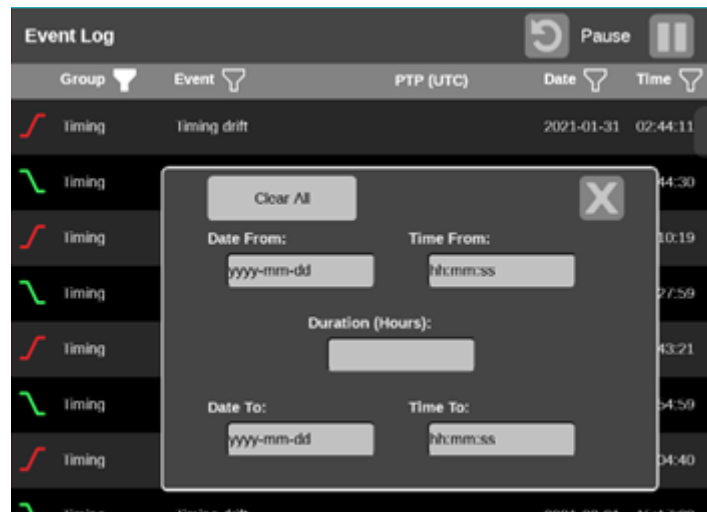

- To move the menu to a location, select-and-hold anywhere in the menu and move it.
- To enter a filter date:
 - Select in the Date From field and either enter a date (yyyy-mm-dd) with a keyboard, or select the date using the on-screen Adjust Date tool.
 - Repeat selecting a date in the Date To field, if needed.

Note: Other filters (duration, time) are not required.

The screenshot shows a filter configuration window with a 'Clear All' button and a close 'X' button. The 'Date From' field contains '2021-03-11'. The 'Time From' field is empty with a placeholder 'hh:mm:ss'. The 'Duration (Hours)' field is empty. The 'Date To' field has a placeholder 'yyyy-mm-dd'. The 'Time To' field has a placeholder 'hh:mm:ss'. Below these fields is an 'Adjust Date From: Date (Y-M-D)' dialog box with a numeric keypad showing '2021 - 2 - 11' and a 'Set' button.

- To enter a filter time:
 - Select in the *Time From* field and either enter a time (hh-mm-ss) with a keyboard—or select the time using the on-screen Adjust Time tool—and select **Enter**.
 - Repeat selecting a time in the *Time To* field, if needed.

Note: Other filters (duration, date) are not required.

The screenshot shows the same filter configuration window. The 'Time From' field is highlighted with a red box and contains 'hh:mm:ss'. The 'Duration (Hours)' field contains '10'. The 'Adjust Time From: Time (H:M:S)' dialog box is open, showing a numeric keypad with '15 : 56 : 12' and an 'Enter' button.

- To enter a duration filter, select in the *Duration* field and enter the number of hours with a keyboard, or use the on-screen keypad, and select **Enter**.

Note: Other filters (date, time) are not required.



- If no date, duration, or time filter is entered (no filter), the filter icon is open.



- If a date, duration, or time filter is entered (a filter is applied), the filter icon is filled.



IP Status Application

The IP Status application provides an overview of the monitored IP stream and shows the status of each program in the stream. After the input signals have been subscribed to using the input settings menu, the traffic on the SFP ports can be viewed using the IP Status application.

Use this application if there are possible IP signal integrity issues. If a flow has a red X, PRISM has detected issues. The next application to use is the IP Session. Depending on the network switch deployed, the traffic may not appear in the IP Status application immediately.

ID	PORT	PROTOCOL	BITRATE	PAYLD	DEST IP	SOURCE IP
9	1	S2022.6	3.118 Gb/s	98	229.1.1.2:50000	192.168.1.1
10	1	S2110.20	0b/s	96	229.20.1.12:50011	192.168.1.1
11	1	S2110.30	0b/s	97	229.30.1.12:50012	192.168.1.1
12	1	S2110.30	0b/s	97	229.30.1.12:50011	192.168.1.1
13	1	S2110.40	0b/s	100	229.40.1.12:50011	192.168.1.1

IP Status Settings Menu

Open the IP Status Settings menu:

1. Select the **Tiles** icon (🧩).
2. Select the tile with the IP Status application.
3. Select the **Tile** icon (⚙️).

Note: The Move icon (↔️) is in the settings menu header. Select this icon to move the settings left or right.

In the IP Status settings menu select **Both** to monitor both Port 1 and Port 2.



With both ports selected there are two traffic bars that show the amount of traffic on each port and a traffic table with a Port column.

- The active monitored streams are always displayed at the top of the list.
- The columns are sortable.
- The selected input is now highlighted in the ID column.
- When the row has a yellow gradient, it indicates a signal that was present and is now gone. Select the reset button at the right side of the banner (at the top) to clear the signals that are no longer there.

ID	PORT	PROTOCOL	BITRATE	PAYLD	DEST IP	SO
✓ 9	1	S2022.6	3.118 Gb/s	98	229.1.1.2:50000	192
● 10	1	S2110.20	0b/s	96	229.20.1.12:50011	192
● 11	1	S2110.30	0b/s	97	229.30.1.12:50012	192
● 12	1	S2110.30	0b/s	97	229.30.1.12:50011	192
● 13	1	S2110.40	0b/s	100	229.40.1.12:50011	192

Status Indicators

There are 4 possible indicators in the left column of an IP Status tile, which describe the signal parameter:

- ✓ Indicates the signal parameter has not been in an error condition.
- ! Indicates the signal parameter was in an error condition but the error has now cleared.
- ✗ Indicates the signal parameter is currently in an error condition.
- Indicates the signal parameter is not being monitored for an error condition.

There are three possible backgrounds, which describe the flow status:

Green background means the flow is present and selected.

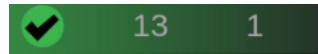

Black background means the flow is present but not selected.



Yellow background means the flow was present but is not, now.



Elements of IP Status Display

- **Port 1** and **Port 2**: Status of Port 1 and Port 2.
- **Total**: Shows the total bit rate of the video in the IP stream.
- **IP stream bandwidth bar**: The blue bar outline at the top of the display represents the total bandwidth of the 10-GE stream (10.3125 Gb/s). The blue bars inside the outline show the relative bandwidth size of items in the IP stream compared to the total available bandwidth of the stream. Numbers inside the blue bars correspond to the ID numbers listed in the display.
- **Run Time**: The instrument maintains a running IP Status Session. The Run Time readout displays the amount of time that has elapsed during the current IP Status Session. The time is displayed as "DD, HH:MM:SS", where DD is number of days, HH is number of hours, MM is number of minutes, and SS is number of seconds.
- **Reset icon**: Select the Reset icon (⏮) to reset the status session. After a reset, items appear in the list in the order they are detected.

The IP Status application is divided into these columns:

ID: Shows the ID number of each item in the IP stream. The ID numbers correspond to the numbers in the blue bar at the top of the display.

PORT: Shows the Port number being monitored.

PROTOCOL: Shows the protocol being used by each item in the IP stream.

BITRATE: Shows the bit rate of each item in the IP stream.

PAYLD: Shows the RTP Payload Type number of each IP stream.

DEST IP: Shows the destination IP address and port number of the monitored stream in the format <destination IP address>:<port number>.

SOURCE IP: Shows the source IP address and port number of the monitored stream in the form <source IP address>:<port number>.

DEST MAC: Shows the destination MAC address of the monitored stream.

SOURCE MAC: Shows the source MAC address of the monitored stream.

PTP DOM: Shows the PTP domain of the monitored stream.

SEQ ERR: Shows the number of sequencing errors in the monitored stream.

- IN-Error count means "IN"-coming stream errors.
- CORR-Error count means after "CORR"-rection process of packet reordering or ST 2022-7. Zero means no errors occurred since reset. Steady count mean errors are not occurring. Increasing count means new errors are occurring.

RTP CLK: Shows the RTP clock of the monitored stream.

RTP MARK: Shows the RTP marker frequency of the monitored stream.

IP Session Application

The IP Session application uses several tabs to display status of various IP stream parameters. Select any of the tab titles to view the associated information: Layer 1/2, Video, Audio, Data, PTP, or NMOS.

Note: Option MP2-IP-MEAS must be installed to use the IP Session application. The display shows only Path 1 unless you enable ST2022-7 Seamless Switching (see [Configure Instrument for HDR/WCG Monitoring](#)). There is a difference between “Port” and “Path”. The Port is the physical SFP port that is used to input the IP signal. Path 1 and Path 2 are the signal paths to be used for seamless switching. This differentiation is being made because it is possible for both Path 1 and Path 2 to use a single Port.

IP Session		Run Time: 0d, 15:11:29		Running <input type="checkbox"/>	
LAYER 1/2	VIDEO	AUDIO-1	DATA	PTP	NMOS
LAYER 1		PORT 1		PORT 2	
✓	25GbE Link	OK		OK	
	SFP Loss Of Signal (LOS)	OK		OK	
LAYER 2		PATH 1		PATH 2	
		STATUS	ERR SECS	STATUS	ERR SECS
✓	Lock	OK	6	OK	6
✓	CRC Error	OK	0	OK	0
LAYER 2 METRICS		PATH 1		PATH 2	
	Rx Bytes	7,616,937,904,320		7,418,943,349,696	
	Rx BER High	0		0	
	Rx CRC Errors	0		0	
	Rx Frames Ok	5,809,973,672		5,674,135,783	
	Rx Frames Errored	0		0	
	Rx Undersize Packets	0		0	
	Rx Oversize Packets	0		0	
	Tx Bytes	8,950,951,217,367		1,143,995	
	Tx Frames Ok	6,745,804,060		12,989	
	Tx Frames Errored	0		0	

IP Session Settings Menu

Open the IP Session Settings menu:

1. Select the **Tiles** icon ().
2. Select the tile with the IP Session application.

3. Select the **Tile** icon (⚙️).

Note: The Move icon (↔️) is in the settings menu header. Select this icon to move the settings left or right.

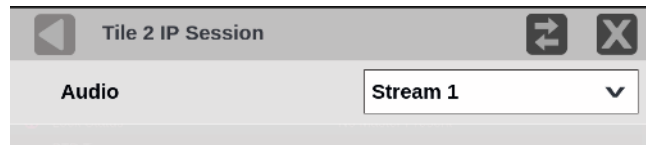

Elements of IP Session Header

The elements at the top of the IP Session application are shared between several tabs:

Display tabs: Select one of the tabs to view the associated display. Each of the tabs has a status indicator to provide a quick view of the status of the parameters contained in each tab.

- **Layer 1/2:** Select to view the status of various signal parameters in the physical and link layers.
- **Video:** Select to view the status of the video in the stream.
- **Audio:** Select to view the status of the audio in the stream.
- **Data:** Select to view the status of the data in the stream.
- **PTP:** Select to view PTP parameters.
- **NMOS:** Select to view information on the registration server and the last Session Description Protocol (SDP) files received.

Run Time: The instrument maintains a running monitoring session for the IP Session application. The Run Time readout displays the amount of time that has elapsed during the current monitoring session. The time is displayed as "DD, HH:MM:SS", where DD is number of days, HH is number of hours, MM is number of minutes, and SS is number of seconds.

Reset icon: Select the Reset icon (⏮️) to reset the monitoring session.

Run / Stop icons: When the monitoring session is running (collecting error data), select the Stop icon (⏸️) to stop the session. When the session is stopped (no error data collection and no display updates), select the Play icon (▶️) to start the session.

LAYER 1/2 Tab Display

Note: In multi-input mode, layer1/2 works with both primary and secondary channels.

Select the LAYER 1/2 tab to view the status of these signal parameters.

IP Session		Run Time: 0d, 02:01:23		Running	
LAYER 1/2	VIDEO	AUDIO	DATA	PTP	NMOS
LAYER 1		PORT 1		PORT 2	
10GbE Link		OK		OK	
SFP Loss Of Signal (LOS)		OK		OK	
		PATH 1		PATH 2	
LAYER 2	STATUS	ERR SECS	STATUS	ERR SECS	
✓ Lock	OK	0	OK	0	
✓ CRC Error	OK	0	OK	0	
LAYER 2 METRICS		PATH 1		PATH 2	
Rx Bytes		1,011,850,536,954		1,015,520,405,677	

- **Layer 1:**

- **10GbE Link** or **25GbE Link:** Shows the status of the link connection.
 - ◆ **Disconnected:** No SFP module present.
 - ◆ **No Signal:** No input signal detected.
 - ◆ **OK:** Locked to input signal.
- **SFP Loss of Signal (LOS):**
 - ◆ **Disconnected:** No SFP module present.
 - ◆ **OK:** Locked to input signal.

Note: Functionality of this signal varies depending on the brand of SFP installed. The signal is intended as a preliminary indication that the received signal strength is below a range specified by the SFP vendor. Such an indication typically points to non-installed cables, broken cables, or a disabled, failing or powered-off transmitter at the far end of the cable.

- **Layer 2:**

- **Lock:** Shows the lock status of the link:
 - ◆ **OK:** The 10/25G Ethernet Phy Rx port is successfully locked to the inbound Ethernet signal.
 - ◆ **ERROR:** The 10/25G Ethernet Phy Rx port lost lock to the incoming Ethernet signal during the last second. This indicates there is likely a physical layer problem with the link.

- **CRC Error columns:**
 - ◆ **STATUS:** There have been no overflow errors in the Ethernet MAC during the last second.
 - ◆ **ERR SECS:** This is an interval of a second during which any error has occurred, regardless of whether that error was a single-bit error, or a complete loss of communication for that entire second.
- **Layer 2 Metrics:**
 - **Rx Bytes:** A count of the number of bytes received
 - **Rx BER High:** The Sync Header BER is greater than 10⁻⁴
 - **Rx CRC Errors:** A count of the number of CRC errors detected
 - **Rx Frames Ok:** A count of the number of Ethernet frames received without error
 - **Rx Frames Errored:** A count of the number of Ethernet frames received with errors detected
 - **Rx Undersize Packets:** A count of the number of Ethernet frames received that are less than 64 bytes long
 - **Rx Oversize Packets:** A count of the number of Ethernet frames received that are greater than 1522 bytes long
 - **Tx Bytes:** A count of the number of bytes transmitted
 - **Tx Frames Ok:** A count of the number of Ethernet frames transmitted without error
 - **Tx Frames Errored:** A count of the number of Ethernet frames transmitted with errors detected

VIDEO Tab Display

Select the VIDEO tab to view the status of the video in the stream.

IP Session		Run Time: 0d, 02:06:01		Running	
LAYER 1/2	VIDEO	AUDIO	DATA	PTP	NMOS
		PORT 1	PORT 2		
L3 IP					
Source Addr		192.168.1.26	192.168.1.27		
Destination Addr		229.20.1.12	229.20.2.12		
L4 UDP					
Source Port		50011	50011		
Destination Port		50011	50011		
L5 RTP					
Version		2	2		

- **L3 IP:**
 - **Source Addr:** Lists the source addresses for the L3 IP layer.
 - **Destination Addr:** Lists the destination addresses for the L3 IP layer.
- **L4 UDP:**
 - **Source Port:** Lists the source ports for the L4 UDP layer.
 - **Destination Port:** Lists the destination ports for the L4 UDP layer.
- **L5 RTP:** Lists these parameters of the L5 RTP (Real Time Protocol) layer. RTP Datagrams are defined in IETF RFC 3550.
 - **Version:** Identifies the version of RTP and should be a value of 2.
 - **Padding:** Indicates whether padding bytes are present. Possible values are:
 - ◆ **false:** Indicates no extra padding bytes are at the end of the RTP packet.
 - ◆ **true:** Indicates that padding octets have been added to the RTP packet that are not part of the payload.
 - **Extension:** Indicates whether an extension is present. Possible values are:
 - ◆ **false:** Indicates no extension is present.
 - ◆ **true:** Indicates an extension is present.
 - **CSRC:** Identifies the Contributing Source IDs. This value should be set to zero.
 - **Marker:** This value should be set to 1 to indicate the last MediaDatagram of the video frame. The value is set to 0 for all other Media Datagrams and should be 0 for most packets.

Note: For 2022-6 signals, the status indicator turns red if the Marker Bit Frequency does not match the frame rate indicated in the HBRMT header. For 2110 signals, the status indicator turns red if the Marker Bit Frequency does not match the measured field rate of the detected format.

- **Payload type:** Identifies the type of RTP payload:
 - ◆ **98:** Indicates an ST 2022.6 High Bit Rate Media Transport.
 - ◆ **99:** Indicates an ST 2022.5 High Bit Rate Media Forward Error Correction (FEC) payload.
 - ◆ **33:** Indicates an ST 2022.2 Constant Bit Rate MPEG-2 Transport Stream Adaptive Sample Picture Encapsulation (ASPEN) payload.

Note: The payload type for ST 2110 streams should be between 96 and 127. The payload type is set by the user.

- **Sequence number:** RTP sequence counter that changes by one for each RTP Media Datagram sent.

Note: The status indicator turns red if the received RTP sequence numbers do not change by 1 on every packet.

- **Time Stamp:** Reflects the sampling instant of the first octet in the RTP datagram. This value can be used to determine packet sequence errors and jitter calculations to be made.
-

Note: For 2022-6 signals, the status indicator turns red if the Time Stamp field does not change at the rate of 27 MHz on every packet. For 2110 signals, the status indicator turns red if the Time Stamp field does not change at the start of every field or frame at the rate of 90 kHz on every packet.

- **SSRC:** Identifies the Synchronization Source ID and is set in compliance with RFC3550. This identifier is chosen randomly and should be unique so no two SSRC have the same value with an RTP session.
 - **Interface Sampling Frequency Error:** This error indicates that the incoming video is arriving at a frequency outside of the supported range to maintain stable video lock. The signal on the SDI Out video connector may be affected. Possible interface sampling frequency declaration in stream header is incorrect for the stream type being carried.
-

Note: The status indicator turns red if the received frame rate is not stable enough during conversion to SDI. Marker Bit Frequency Errors can also trigger this indicator.

- **HBRMT:** Lists these parameters of the High Bit Rate Media Payload Header:
-

Note: The HBRMT parameters only apply to ST2022-6 streams.

- **Video Source Format:** Identifies whether source formatting is present:
 - ◆ **Not Present:** Indicates no Source Format information is present.
 - ◆ **Present:** Indicates source formatting is present.
 - **Video Source ID:** Identifies the video source:
 - ◆ **Primary (0x0):** Indicates a primary stream.
 - ◆ **Protect (0x1):** Indicates a protected stream.
 - ◆ **Reserved (n):** When *n* is a number other than 0 or 1, indicates that a reserved value is being used.
 - ◆ **Frame Count:** The Video Frame counter changes in value for the next RTP sequence and rolls over after 255.
-

Note: The status indicator turns red if the frame count field does not change by 1 at the start of every frame.

- **Reference for time stamp:** Identifies the time stamp reference:
 - ◆ **Unlocked (0x0):** Indicates the time stamp is not locked to any particular source.
 - ◆ **Reserved (0x1):** Indicates an illegal value.
 - ◆ **UTC (0x2):** Indicates the time stamp is locked to a UTC time source.
 - ◆ **Private (0x3):** Indicates the time stamp is locked to a private time source.
- **Video Payload Scrambling:** Identifies the payload scrambling status:
 - ◆ **Unscrambled (0x0):** Indicates the payload is not scrambled.
 - ◆ **Reserved (n):** When *n* is a number other than 0, it indicates a reserved value is being used.
- **FEC usage:** Identifies the FEC usage status:
 - ◆ **No FEC (0x0):** Indicates no forward-error correction is being used.
 - ◆ **Column (0x1):** Indicates column FEC is being used.
 - ◆ **Col/Row (0x2):** Indicates column and row FEC are being used.
 - ◆ **Reserved (n):** When *n* is a number greater than 2, indicates a reserved value is being used.
- **Clock Frequency:** Identifies the video word clock frequency of the payload video. Possible values are:
 - ◆ **0000:** No time stamp
 - ◆ **0001:** 27 MHz
 - ◆ **0010:** 148.5 MHz
 - ◆ **0011:** 148.5 /1.001 MHz
 - ◆ **0100:** 297 MHz
 - ◆ **0101:** 297/1.001 MHz
 - ◆ **0110-1111:** Reserved
- **Reserved:** This value should be set to 0.
- **Video Source Format fields:** These Video Source Format field values are displayed:
 - ◆ **MAP:** Identifies which SMPTE mapping scheme is used. Possible values are: Direct (0x0), LevelB (0x1), 2xHD (0x2), or Reserved (n).
 - ◆ **FRAME:** Identifies the raster size. Possible values are: Unspecified (0x0), 720x480i (0x10), 720x576i (0x11), 1920x1080i (0x20), 1920x1080p (0x21), 1920x1080sf (0x22), 2048x1080p (0x23), 2048x1080sf (0x24), or 1280x720p (0x30).
 - ◆ **F rate:** Identifies the frame rate. Possible values are: Unknown/Unspecified frame rate 2.970 GHz signal (0x00), Unknown/Unspecified frame rate 2.970/1.001 GHz signal (0x01), Unknown/Unspecified frame rate 1.485 GHz signal (0x02), Unknown/Unspecified frame rate 1.485/1.001 GHz signal (0x03), Unknown/Unspecified frame rate 0.270 GHz signal (0x04), Reserved (0x04-0x0f), 60 (0x10), 60/1.001 (0x11), 50 (0x12), Reserved (0x13), 48 (0x14), 48/

1.001 (0x15), 30 (0x16), 30/1.001 (0x17), 25 (0x18), Reserved (0x19), 24 (0x1A), 24/1.001 (0x1B), Reserved (0x1C-0xFF).

◆ **Sample:** Identifies the pixel sampling/quantization scheme. Possible values are: Unspecified (0x0), 4:2:2/10 bit (0x1), 4:4:4/10 bit (0x2), 4:4:4/10 bit (0x3), 4:2:2/12 bit (0x5), 4:4:4/12 bit (0x6), 4:4:4/12 bit (0x7), or 4:2:2/12 bit (0x8).

◆ **Fmt-Reserve:** This bit is reserved for future use and is set to 0.

- **Video TimeStamp:** Shows the value of a free-running counter that is synchronous with the interface word clock of the encapsulated video. This timestamp is fixed at the transmitter to the first information contained in the datagram.
- **Header Extension:** Indicates the number of 4-octet header extension words that come after the HBRMT payload.

Audio Tab Display

Select the AUDIO tab to view the status of the audio in the stream.

IP Session		Run Time: 0d, 15:19:45	Running		
LAYER 1/2	VIDEO	AUDIO-1	DATA	PTP	NMOS
		PORT 1	PORT 2		
L3 IP					
Source Addr		173.100.1.2	173.100.1.2		
Destination Addr		229.30.21.2	229.30.21.2		
L4 UDP					
Source Port		50000	50000		
Destination Port		50030	50030		
L5 RTP					
Version		2	2		

Set the Audio Stream

1. Select the **Tile** icon (⚙️) in the application bar to open the IP Session Settings menu.
2. Select the **Audio** tab and select the stream number to monitor.
The selected audio stream is noted in the AUDIO tab.

IP Session		Run Time: 0d, 15:40:24	Running		
LAYER 1/2	VIDEO	AUDIO-4	DATA	PTP	NMOS
		PORT 1	PORT 2		
L3 IP					
Source Addr		173.100.1.2			
Destination Addr		229.30.24.2			

AUDIO Tab Display Elements

- **L3 IP:**
 - **Source Addr:** Lists the source addresses for the L3 IP layer.
 - **Destination Addr:** Lists the destination addresses for the L3 IP layer.
- **L4 UDP:**
 - **Source Port:** Lists the source ports for the L4 UDP layer.
 - **Destination Port:** Lists the destination ports for the L4 UDP layer.
- **L5 RTP:** Lists these parameters of the L5 RTP (Real Time Protocol) layer. RTP Datagrams are defined in IETF RFC 3550.
 - **Version:** Identifies the version of RTP and should be a value of 2.
 - **Padding:** Indicates whether padding bytes are present. Possible values are:
 - ◆ **false:** Indicates no extra padding bytes are at the end of the RTP packet.
 - ◆ **true:** Indicates that padding octets have been added to the RTP packet that are not part of the payload.
 - **Extension:** Indicates whether an extension is present. Possible values are:
 - ◆ **false:** Indicates no extension is present.
 - ◆ **true:** Indicates an extension is present.
 - **CSRC:** Identifies the contributing source IDs. This value should be set to 0.
 - **Marker:** This value should be set to 1 to indicate the last media datagram of the video frame. The value is set to 0 for all other media datagrams and should be 0 for most packets.
 - **Payload type:** Identifies the type of RTP payload.
 - **Sequence number:** RTP sequence counter changes by one for each RTP media datagram sent.

Note: The status indicator turns red if the received RTP sequence numbers do not change by 1 on every packet.

- **Time Stamp:** Reflects the sampling instant of the first octet in the RTP datagram. This value can be used to determine packet sequence errors and jitter calculations to be made.

Note: The status indicator turns red if the Time Stamp field does not change at 48-kHz rate on every group of audio samples.

- **SSRC:** Identifies the synchronization source ID and is set in compliance with RFC3550. This identifier is chosen randomly and should be unique so no two SSRC have the same value with an RTP session.

Data Tab Display

Select the **DATA** tab to view the status of the data in the stream.

IP Session		Run Time: 0d, 02:25:13	Running
LAYER 1/2	VIDEO	AUDIO	DATA
PORT 1		PORT 2	
L3 IP			
Source Addr	192.168.1.26	192.168.1.27	
Destination Addr	229.40.1.12	229.40.2.12	
L4 UDP			
Source Port	50011	50011	
Destination Port	50011	50011	
L5 RTP			
Version	2	2	

- **L3 IP:**
 - **Source Addr:** Lists the source addresses for the L3 IP layer.
 - **Destination Addr:** Lists the destination addresses for the L3 IP layer.
- **L4 UDP:**
 - **Source Port:** Lists the source ports for the L4 UDP layer.
 - **Destination Port:** Lists the destination ports for the L4 UDP layer.
- **L5 RTP:** Lists the parameters of the L5 RTP (Real Time Protocol) layer. RTP datagrams are defined in IETF RFC 3550.
 - **Version:** Identifies the version of RTP and should be a value of 2.
 - **Padding:** Indicates whether padding bytes are present. Possible values are:
 - ◆ **false:** Indicates no extra padding bytes are at the end of the RTP packet.
 - ◆ **true:** Indicates that padding octets have been added to the RTP packet that are not part of the payload.
 - **Extension:** Indicates whether an extension is present. Possible values are:
 - ◆ **false:** Indicates no extension is present.
 - ◆ **true:** Indicates an extension is present.
 - **CSRC:** Identifies the Contributing Source IDs. This value should be set to zero.
 - **Marker:** This value should be set to 1 to indicate the last media datagram of the video frame. The value is set to 0 for all other media datagrams and should be 0 for most packets.

Note: For 2022-6 signals, the status indicator turns red if the Marker Bit Frequency does not match the frame rate indicated in the HBRMT header. For 2110 signals, the status indicator turns red if the Marker Bit Frequency does not match the measured field rate of the detected format.

- **Payload type:** Identifies the type of RTP payload.
 - **Sequence Number:** RTP sequence counter changes in increments of one for each RTP media datagram sent.
 - **Time Stamp:** Reflects the sampling instant of the first octet in the RTP datagram. This value can be used to determine packet sequence errors and jitter calculations to be made.
-

Note: For 2022-6 signals, the status indicator turns red if the Time Stamp field does not change at the rate of 27 MHz on every packet. For 2110 signals, the status indicator turns red if the Time Stamp field does not change at the start of every field or frame at the rate of 90 kHz on every packet.

- **SSRC:** Identifies the synchronization source ID and is set in compliance with RFC3550. This identifier is chosen randomly and should be unique so no two SSRC have the same value with an RTP session.

PTP Tab Display

Note: PTP is supported in multi-input mode.

Select the PTP tab to view the status of the PTP elements in the stream. PTP is currently only supported on 10/25 GE SFP Port 1, for instructions on locking to PTP see [Configure Reference Settings](#).

The screenshot shows the IP Session interface with the PTP tab selected. At the top, it displays 'IP Session', 'Run Time: 0d, 00:48:34', a refresh icon, and a 'Running' status with a checkbox. Below this is a navigation bar with tabs for LAYER 1/2, VIDEO, AUDIO, DATA, PTP (selected), and NMOS. Each tab has a status indicator: LAYER 1/2 (green check), VIDEO (red X), AUDIO (green check), DATA (green check), PTP (green check), and NMOS (grey). The main content area shows a list of PTP parameters:

✓ Lock Status	Locked
PTP Time	2018-06-12 22:28:54 (UTC)
Master/Slave Phase Lag	+ 83 ns
Grandmaster ID	08:00:11:ff:fe:21:90:2b
Steps Removed	2
Domain	110
Profile	General
Delay Message Interval	Follow Master
Grandmaster BMCA Values	

- **Lock Status:** Indicates whether the instrument PTP slave is locked to the master PTP signal for the selected domain. These values may appear:
 - **No master present:** Indicates that the master PTP clock has not been detected on the selected domain.
 - **Locked:** Indicates that the master PTP clock is detected and there is less than 1000 ns of phase lag between the master clock and the instrument.
 - **Unlocked:** Indicates that the master PTP clock is detected and there is greater than 1000 ns of phase lag between the master clock and the instrument.
- **PTP time:** Shows the time derived from the PTP Master as UTC (Coordinated Universal Time).
- **Master/Slave Phase Lag:** Shows the detected offset between the master and slave clocks.
- **Grandmaster ID:** Shows the MAC Address of PTP Master with the bytes ff:fe inserted in the middle. This ID is also used in the BMCA as a tiebreaker if all of the parameters match down through priority 2.
- **Steps Removed:** Shows the number of communication paths traversed between the local clock and the Grandmaster clock.
- **Domain:** Shows the domain being used. Domains allow multiple PTP services to coexist simultaneously on one physical Ethernet connection.
- **Profile:** Shows the profile being used: General, AES67, or ST2059. This is the user-selected profile set on the Settings, Reference configuration menu page and is not detected on the input.
- **Delay Message Interval:** For Multicast communication mode, the only delay message interval allowed is "Follow Master". In this mode, the slave sets the delay request rate according to the information sent by the master in the delay response message.

Note: The PRISM monitor currently supports Multicast communication mode and SMPTE mixed mode without negotiation.

- **Grandmaster BCMA Values:** Lists these values for the Grandmaster BCMA (Best Master Clock Algorithm) in order of precedence:
 - **Priority 1:** This parameter defines which clocks are allowed to be considered as masters. To be considered as a master, the value should be set to 128 or less. Priority 1 is the first criteria in the BMCA, so if Priority 1 is set to a lower value than other devices on the system, then it is chosen even if the clock quality is poor. Typically, all the masters in a domain should have the same value for the Priority 1 parameter.
 - **Clock Class:** This value characterizes the TAI (International Atomic Time) traceability. The clock class value varies to indicate the type of reference in use by the Grandmaster clock. For example, when locked to GPS the PTP

grandmaster reports a class 6. However, if in holdover mode after locking to GPS, then it reports a class of 7.

- **Clock Accuracy:** This value characterizes the clock accuracy for the purpose of determining the best master clock.
- **Clock Variance:** This value is reported by the PTP master to indicate the variance of the clock over a one second interval. A lower number indicates a more stable clock and is preferred by the BMCA.
- **Priority 2:** This parameter is used to break the tie between masters that have the same clock quality. Several values may be used to define a hierarchy of devices. Most profiles use 128 as a default, so a value of 127 or lower would indicate a preferred master.
- **Clock Source:** The clock source field is not used by the BMCA. The field is set to indicate the type of reference in use by the Grandmaster clock.
- **Communication Mode:** There are three basic message modes for PTP: Multicast, Unicast, and mixed Multicast and Unicast. For full Multicast or Unicast modes, all of the PTP messages are sent in the selected mode type.

Note: The PRISM monitor currently supports Multicast communication mode and SMPTE mixed mode without negotiation. In later firmware releases, other communication modes will be supported.

For some profiles, such as some telecom profiles and the ST2059 profile, a mixture of Multicast and Unicast are allowed. On the SMPTE profile unique mixed mode, the Announce and Sync messages are sent as multicast. However, the Delay request and Delay Response messages are sent as Unicast.

Some points to understand about communication modes:

- Whatever mode is chosen, the master and slave must match or be compatible.
 - Multicast and Mixed modes may need IGMP joins and leaves Full Unicast must have the master address in all slave AMTs.
 - Unicast without negotiation does not allow master to regulate load.
 - Two masters can be used on different domains to serve slaves on different communication modes.
- **Delay Mechanism:** Shows the delay mechanism mode being used:

Note: The PRISM monitor currently supports only the End-to-End delay mechanism.

- **End-to-End:** In this mode, the sync, follow-up, delay-request, and delay-response messages go through the network all the way between the master and slave. End-to-End mode is useful in PTP networks where some or all devices are not PTP aware.
- **Peer-to-Peer:** In this mode, the Pdelay-request and Pdelay-response messages are local to each link in the network. Each device determines the local link and device delays. The sync message from the master then collects the corrections

as it propagates from the master to slave. Peer-to-Peer mode is useful in PTP networks where the routing configuration changes. For Peer-to-Peer mode to work well, all of the devices need to be PTP aware.

- **Message rates:**

- **Announce:** Displays the rate of the Announce messages received from the master. Typical values are 1 to 4 messages a second, but a wide range is allowed by some profiles. If the value is lower than expected, it may indicate a problem in the network or the master.
- **Sync:** Displays the rate of the Sync messages received from the master. Typical values are 1 to 16 messages a second, but some profiles allow much higher rates. If the value is lower than expected, it may indicate a problem in the network or the master.
- **Delay Request:** Displays the rate of the Delay Request messages sent by the slave. In multicast mode, the Delay Request rate is required to be set in response to a field in the Delay Response message from the master. Typically the master sets this field such that the Delay Request message rate is equal to the Sync message rate.

Note: For SMPTE mixed mode, PRISM sets the delay Request rate equal to the Sync message rate received from the master.

- **Delay Response:** Displays the rate of the Delay Response messages received from the master. Each Delay Request should have a matching Delay Response, so if the value is lower than expected then it may indicate a problem in the network or the master

NMOS Tab Display

Select the NMOS tab to view the registration server information, server list and the last SDP file received.

To enable and configure NMOS see [Enable NMOS](#).



Registration Server: Shows the Host Name and IP Address of the registration server.

Registration Server List: Select the Registration Server List tab to view the Host Name, IP Address, and Priority of the servers registered to this instrument using NMOS.

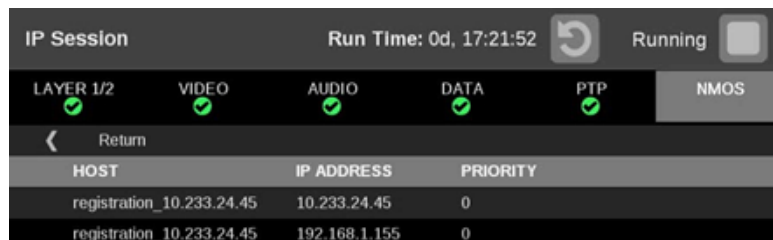

Note: Select **Return** to go back to the main IP Session NMOS menu.

Last SDP File Received: Select the Last SDP File Received tab view video, audio, and data SDP files. These files contain information used to configure input signals from the registration servers.

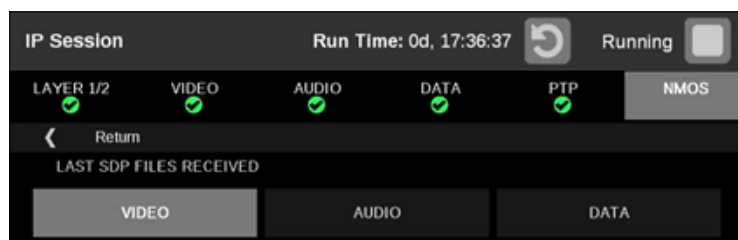

Note: Select **Return** to go back to the main IP Session NMOS menu.

IP Graphs Application

Note: IP Graphs are not supported in multi-input mode because IP inputs are not supported in multi-input mode.

Use the IP Graphs application to view various graphs that show aspects of the IP stream. As you scroll through the various graphs, the top of the selected graph moves to the top of the display area to help view the complete graph. The displayed graph is included in a saved preset.

Note: Option MP2-IP-MEAS must be installed to use the IP Graphs application.



If ST 2022-7 monitoring is configured, the IP Graphs application includes Path 1 and Path 2. The graph data can be switched between viewing only Path 1, only Path 2, or both by selecting the Path button in the upper right of the screen.

Note: The Path button only works with 2022-7 seamless switching enabled in input configuration.

Note: If 2110 monitoring is configured, you can select Video, Audio (1 stream at a time, selectable in Tile Settings), or Data.

If ST 2022-6 monitoring is configured, the IP Graphs include:

Video CRC Error graph: The Video CRC Error graph shows any present CRC errors in the currently decoded signal and can be compared to other time graphs such as RTP Sequence Errors.

TS-DF graph: The TS-DF graph shows the Time Stamped Delay Factor, as defined in EBU Tech 3337, which is a method for measuring network jitter in RTP streams.

IP Graphs Settings Menu

Open the IP Graphs Settings menu:

1. Select the **Tiles** icon (🗄️).
2. Select the tile with the IP Graphs application.
3. Select the **Tile** icon (⚙️).

Note: The Move icon (↔️) is in the settings menu header. Select this icon to move the settings left or right.

Trend Interval

Select the Trend Interval menu and select the interval: 1 minute, 5 minute, 10 minute, 30 minute, 1 hour, 3 hour, 6 hour, 12 hour, or 1 day.

Audio

Select the Audio menu and select a stream to monitor. The monitored stream is noted in the IP Graphs header, next to the Stream type button.

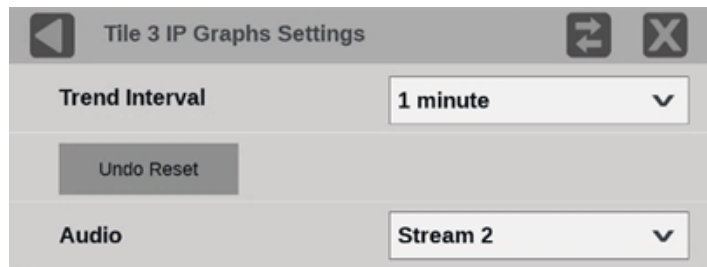

Elements in IP Graphs Application Display

The elements at the top of the IP Graphs application are shared between all graphs.

Note: Only Path 1 displays unless you enable ST 2022-7 Seamless Switching, (see [Configure Instrument for HDR/WCG Monitoring](#)).

- **PATH 1** and **PATH 2:** Describes the two information paths.
- **Port:** Shows the physical port used on the instrument.
- **Src:** Lists the source address of the IP stream.
- **Dest:** Lists the destination address of the IP stream.
- **Protocol:** Lists the protocol being used by the monitored stream.
- **PRS:** Shows the Packet Read Schedule (PRS) defined in the input video settings.
- **Clear icon:** Select the Clear icon (🗑️) to reset the monitoring session.

- **Stream type:** Select this button to change to Video (V), Audio (A), or Data (D) stream IP graphs.
- **Path:** Select the Path button to change to Path 1, Path 2, or both Path 1 and 2.
- **Res:** Lists the resolution of the graph display at the bottom right of the graph.

IP Graphs ↺ V 1-2 Paths

PATH 1	Port: SFP-1	Src: 192.168.1.26:50011	Dest: 229.20.1.12:50011	Protocol: S2110.20
PATH 2	Port: SFP-2	Src: 192.168.1.27:50011	Dest: 229.20.2.12:50011	PRS: Wide Linear

Total Bit Rate Graph

The Total Bit Rate graph shows the total bit rate currently on the 10/25 GE input. The maximum available bandwidth is 10.3 Gb/s. These readouts appear:

- **Max:** Shows the maximum bandwidth used during the time window.
- **Mean:** Shows the mean bandwidth used during the time window.
- **Min:** Shows the minimum bandwidth used during the time window.
- **Free Min:** Shows the minimum available bandwidth that is not in use.
- **Free Max:** Shows the maximum available bandwidth that is not in use.

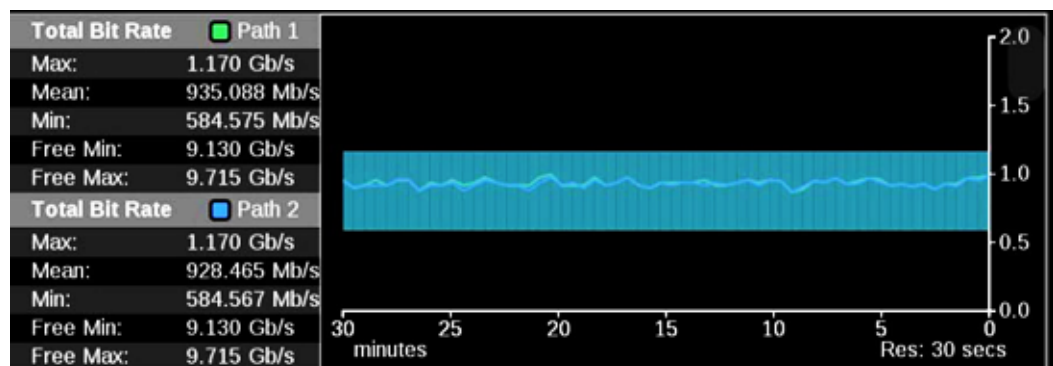

Session Bit Rate Graph

The Session Bit Rate graph shows the data rate of the currently selected input stream.

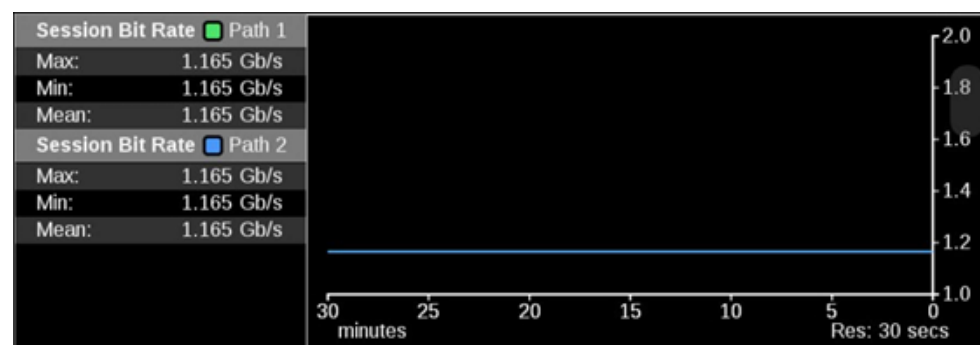

PIT Graph

The PIT (Packet Interval Time) graph shows the difference in arrival time between sequential packets of the active stream. This is one indication of the packet jitter and dropped packet rate. The colored bars represent the range from minimum to maximum for all of the packets within that time interval.

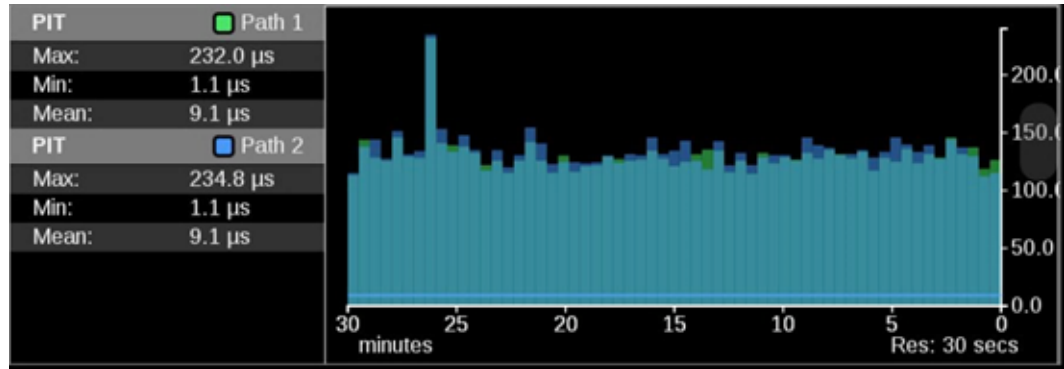

RTP Sequence Error Graph

RTP Sequence Error: Shows the RTP sequence information and reports if any packet is received out of order.

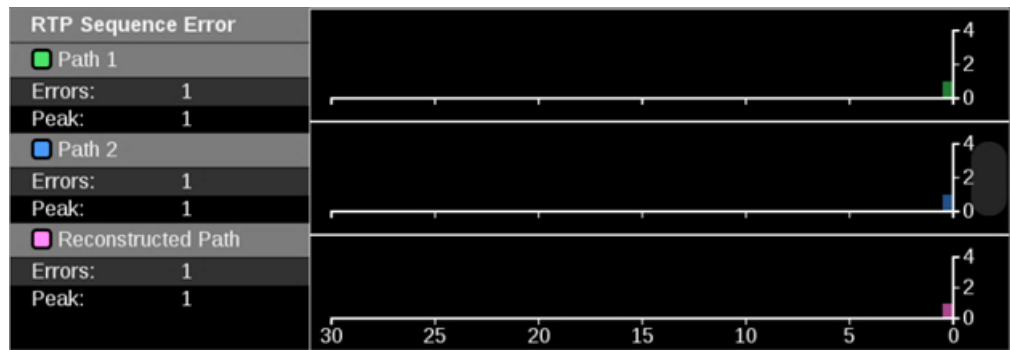

Reconstructed path errors: 0 means no sequence error have been detected and any number (not 0) means sequence error or errors detected after RTP packet reordering on each path and ST2022-7 seamless reconstruction process.

Path1-Path2 Differential Graph

Path Differential represents the time difference between the Path 1 and Path 2 streams in an ST 2022-7 system. As the path differential gets larger, it becomes more difficult for equipment receiving the data to properly process both paths, depending on the size of the input buffer in the equipment.

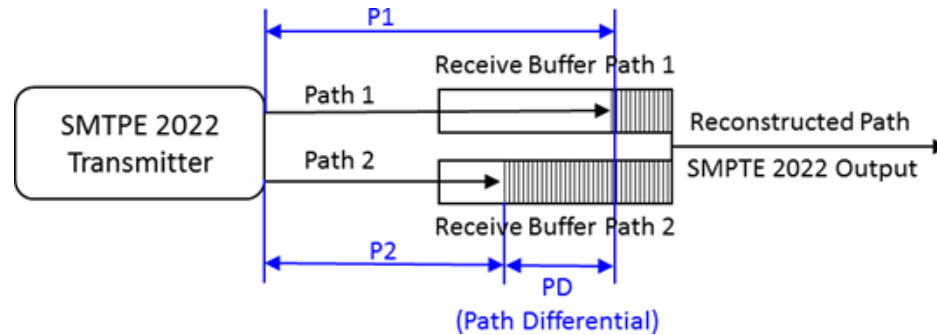

The ST 2022-7 specification defines Path Differential as an absolute value, but the Path1-Path2 Differential graph shows the signed value of Path 1 minus Path 2. A positive value means that Path 2 is lagging Path 1. The ST 2022-7 specification defines Path Differential as an absolute value, but the Path1-Path2 Differential graph shows the signed value of Path 1 minus Path 2. A positive value means that Path 2 is lagging Path 1.

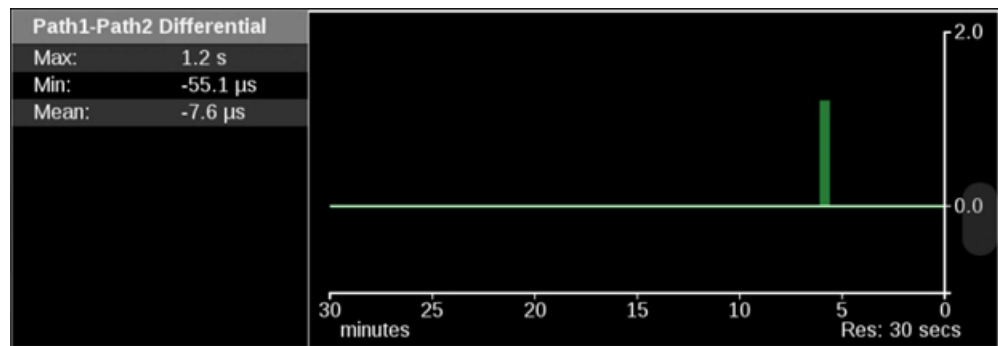

Note: The measurement range of Path1-Path2 differential measurement is 1 second.

Note: The Path1-Path2 differential measurement is not supported for ST 2110-30.

CMAX and VRX Buffer Graph

ST 2110-21 specifies a timing model for ST 2110-10 video RTP streams with these parametric models:

Note: The CMAX and VRX trend graphs are not available for streams 525i 59.94 and 650i 50. The graphs are also not available on SFP 2.

Note: Make sure the input signal and PRISM are locked to PTP for these measurements.

- A network compatibility model to regulate the burst characteristics of senders, which promotes the compatibility with the switches. The CMAX section provides a trend graph for this type of modeling.
- A virtual receiver buffer model to ensure there is no buffer overflow or underflow in the receiver that could cause the packet loss and picture quality degradation. The VRX Buffer section provides a trend graph for this type of modeling.

Both trend graphs help engineers properly setup the packet delivery timing in the RTP packet sender.

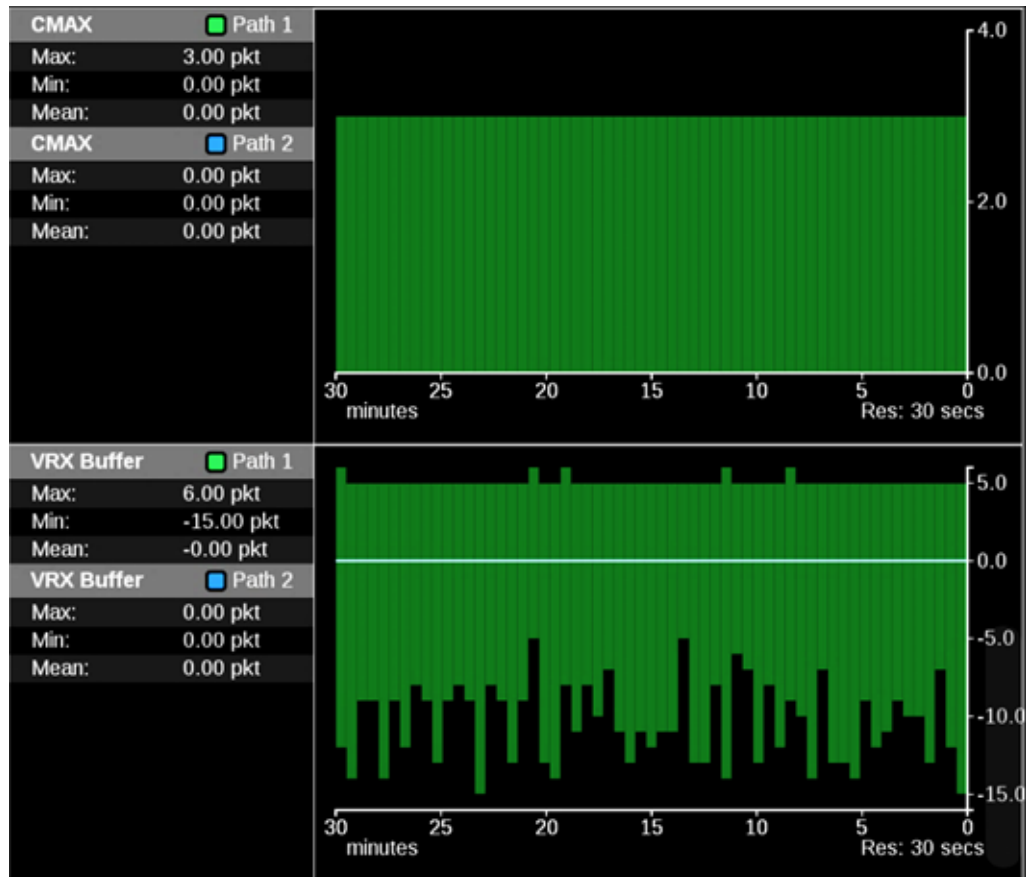

PIT Histogram Application

Note: PIT Histogram is not supported in multi-input mode because IP inputs are not supported in multi-input mode.

Use the PIT (Packet Interval Time) Histogram application to monitor the network delay variation statistics.

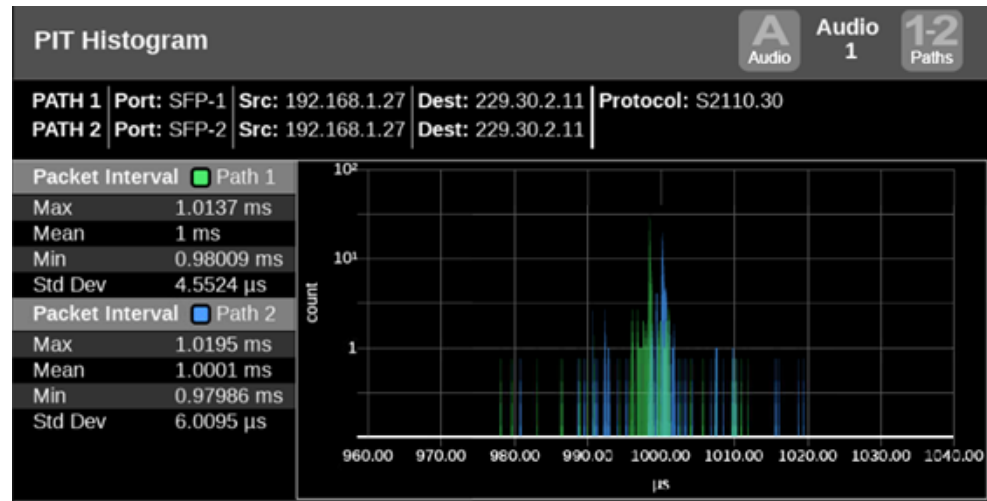

Note: If ST 2110 monitoring is configured, you can select Video, Audio (1 stream at a time, selectable in Tile Settings), or Data.

PIT Histogram Settings Menu

Open the PIT Histogram Settings menu:

1. Select the **Tiles** icon (🧩).
2. Select the tile with the PIT Histogram application.
3. Select the **Tile** icon (⚙️).

Note: The Move icon (↔️) is in the settings menu header. Select this icon to move the settings left or right.

Select a Y-Axis scaling option: Linear or Log.

Audio: Select the Audio menu and choose the audio stream to monitor. The selected audio stream is noted in the PIT Histogram heading next to the monitored path.

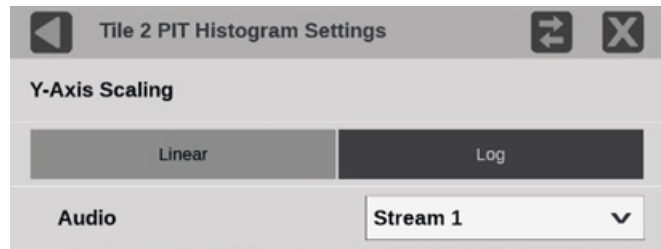

Elements of PIT Histogram Display

Port 1 and **Port 2:** Shows the physical ports on the instrument.

Src/Dest: Lists the source and destination addresses of the IP stream.

Protocol: Lists the protocol being used by the monitored stream.

Path: Select the button, in the top-right corner of the tile, to switch between Path 1 only (green), Path 2 only (blue), or both Path 1 and Path 2 data (cyan where Path 1 and 2 are overlapped).

Note: The Path button only works with ST 2022-7 seamless switching enabled in input configuration.

Stream type: Select to switch between the video, audio, or data stream IP graphs.

Note: The Stream Type button is only available with ST 2110 streams.

Packet Interval information:

Max: Shows the maximum packet interval time.

Mean: Shows the mean packet interval time.

Min: Shows the minimum packet interval time.

Std Dev: Shows the standard deviation of the packet interval time.

Use the pinch and pinch-out gestures on the graph to zoom in and out. After using the zoom-in gesture, the text "Zoomed" is displayed on the bottom of the graph.

Note: When using a keyboard and mouse, click-and-drag to zoom in.

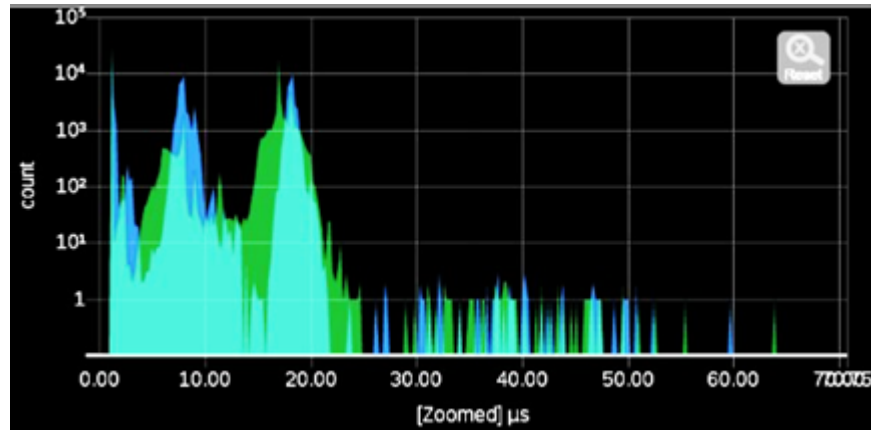

Select the **Reset** button () to set the graph back to autoscale mode.

Note: The Reset button is only displayed after zooming in.

PTP Graphs Application

Use the PTP Graphs application to monitor the message timing between master and slave in a PTP network.

For more information on PTP operations and settings, see [Configure Reference Settings](#) and [PTP Introduction](#).

Note: Option MP2-IP-MEAS must be installed to use the PTP Graphs application.

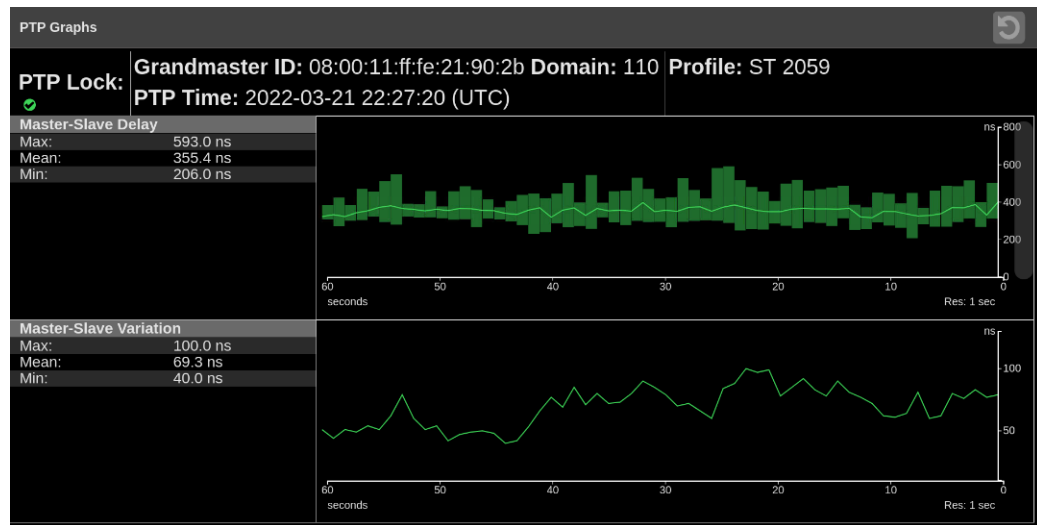

Open PTP Graphs Settings Menu

Open the PTP Graphs Settings menu:

1. Select the **Tiles** icon (🧩).
2. Select the tile with the PTP Graphs application.
3. Select the **Tile** icon (⚙️).

Note: The Move icon (↔️) is in the settings menu header. Select this icon to move the settings left or right.

Select the PTP Trend Interval menu and choose the interval. The PTP Trend Interval defines the extent of the horizontal axis on the graph.

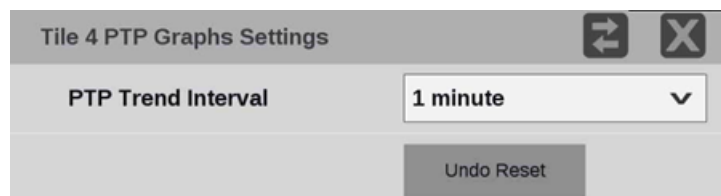

Elements of PTP Graph

The PTP graphs are useful in observing the effects of traffic on the PTP messages and the operation of transparent and boundary clocks. Non-PTP aware switches may have significant PTP delay variations, while transparent and boundary clocks have much less variation and total delay.



- **PTP Lock:** Shows the status of the PTP lock.
 - **Grandmaster ID:** Displays the reference Source and Domain.
 - **Domain:** Can be changed in **Settings** icon (⚙️), in **Reference**.
 - **Profile:** Shows the profile that has been selected in the reference settings menu. This is not detected from the incoming PTP messages.
 - **PTP Time:** Time of day derived from the PTP signals.
 - **Res (Resolution):** Shows the time increment for each bar on the display. Longer graph settings collect data into larger bins to be displayed. This range and resulting resolution are selected in the setting menu for PTP graphs.
- **Trace Types:** There are four displays available. For each one, the Max., Min., and Mean (average) are shown on the left, while the traces versus time is shown on the right. The traces indicate the Max, and Min envelope, and the Mean (average) for each time bin. The time scale can be adjusted in the settings menu. The data is logged for 1 day so you can go back and look at long-term trends.

Use the control to move the displays up or down.

 - **Slave-Master Delay:** This graph indicates the difference in the timestamps for the PTP Sync messages; these go from the master to the slave. This display indicates effects of the downstream network delay and adjustments made to the slave clock. After the slave is locked and the timing is stable, the perturbations

on this graph are largely due to network variations. Traffic often causes some messages to be delayed so the maximum delay increases.

As the PTP is locking, the slave clock adjusts, so the trace may have large swings or jumps. As the system locks, the master-to-slave and slave-to-master delays should converge on the same value. This value represents the average network delay between the master and slave for the traffic in both directions.

If the network delay is too unstable, then the PTP might never lock. This appears as large variations on this trace.

- **Master-Slave Variation:** The master-to-slave variation graph is derived from the same data as the master-to-slave delay. The absolute value of the changes in delay are filtered according to RFC1889 and displayed. This display then shows a measure of the variation of the network delay. A low value indicates a PTP slave is likely to quickly lock, a large value indicates it could be difficult for a PTP slave to lock.

- **Slave-to-Master Delay:** This graph indicates the difference in the timestamps for the PTP Delay Request messages that go from the slave to the master. This display indicates effects of the upstream network delay and adjustments made to the slave clock. After the slave is locked and the timing is stable, the perturbations on this graph are largely due to network variations. Traffic often causes some messages to be delayed so the maximum delay increases.

As the PTP is locking, the slave clock adjusts, so the trace may have large swings or jumps. As the system locks, the master-to-slave and slave-to-master-delays should converge on the same value. This value represents the average network delay between the master and slave for the traffic in both directions.

If the network delay is too unstable, then the PTP might never lock. This appears as large variations on this trace.

- **Slave-to-Master Variation:** The master-to-slave variation is derived from the same data as the master-to-slave delay. The absolute value of the changes in delay are filtered according to RFC1889 and displayed. This display then shows a measure of the variation of the network delay. A low value indicates a PTP slave is likely to quickly lock. A large value indicates it could be difficult for a PTP slave to lock.

- **PTP Phase Lag:** The graph shows the error in the slave clock phase as measured by the PTP timestamps. This value is used to adjust the slave clock to drive the error toward zero.

The PTP phase lag is the phase error of the phase-locked loop, which controls the slave clock. The phase lag is a reasonable estimate of how well the PTP slave is locked to the master; however, the phase lag does not indicate if there is any asymmetry in the network.

Stream Timing Application

Note: Stream Timing is not supported in multi-input mode because IP inputs are not supported in multi-input mode.

The Stream Timing application shows the timing of the video, audio, and data as it was received relative to the embedded RTP timestamps. It also shows the relative delay between Audio/Video and the Data/Video, which is the amount of delay needed to realign the two essence types.

Note: The Stream Timing application requires Option MP2-IP-MEAS.

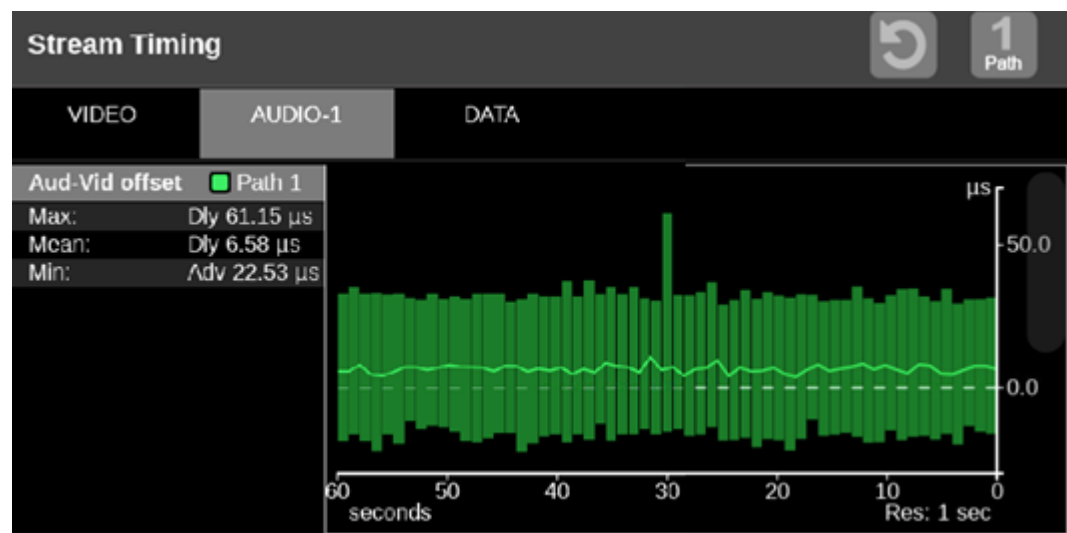

Open Stream Timing Settings Menu

Open the Stream Timing Settings menu:

1. Select the **Tiles** icon (🗄).
2. Select the tile with the Stream Timing application.

3. Select the **Tile** icon (⚙️).

Note: The Move icon (↔️) is in the settings menu header. Select this icon to move the settings left or right.

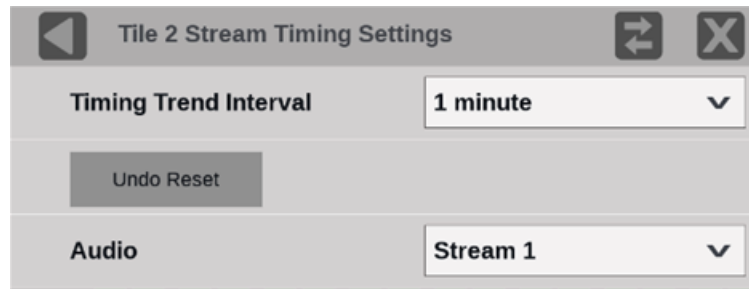

4. Select the Timing Trend Interval menu and select the interval.

To undo the last clear or reset of the monitoring session, select **Undo Reset**.

5. Select the Audio menu and choose the audio stream to monitor. The selected stream is noted in the AUDIO tab label.

Elements of Stream Timing Display

The elements at the top of the Stream Timing application are shared between all graphs:

Note: Only Path 1 displays, unless you enable ST 2022-7 Seamless Switching. (See [Configure Instrument for HDR/WCG Monitoring](#).)

Clear: Select the Clear icon (⊗) to reset the monitoring session.

Path: Select the Path button to switch between Path 1, Path 2, or both Path 1 and Path 2.

Stream type tabs: Select these tabs to switch between the stream offset graphs:

- VIDEO
- AUDIO

Note: The number in the AUDIO tab is the selected stream.

- DATA

Res: Lists the resolution of the graph display.

Video Offset Tab

This tab has options to see the timing and data between the video stream and PTP or RTP offset.

Vid-PTP

The graph shows the relative delay between video stream and PTP. This value indicates the amount of delay that must be applied to realign the video and PTP according to the timestamps. This is a time-based graph of the Timing Display application.

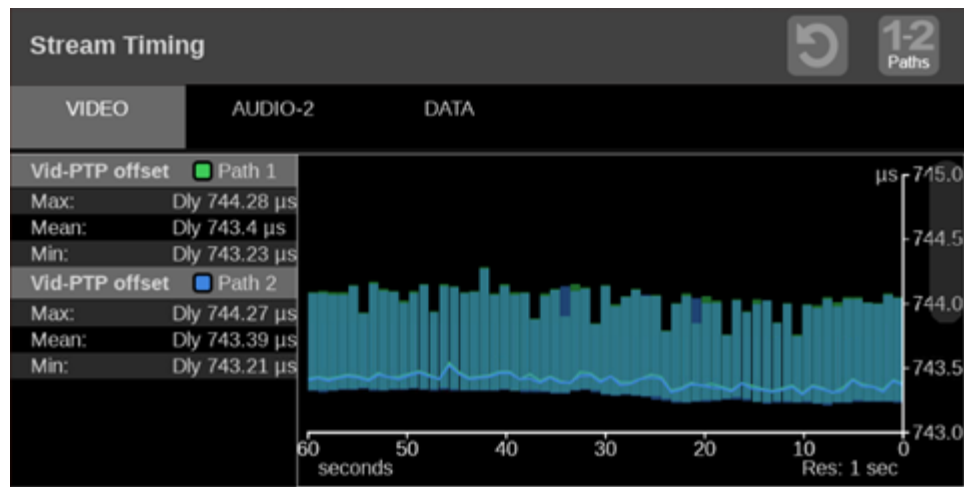

Vid-RTP Offset

The graph shows timing of the video stream as it was received relative to the embedded RTP timestamps.

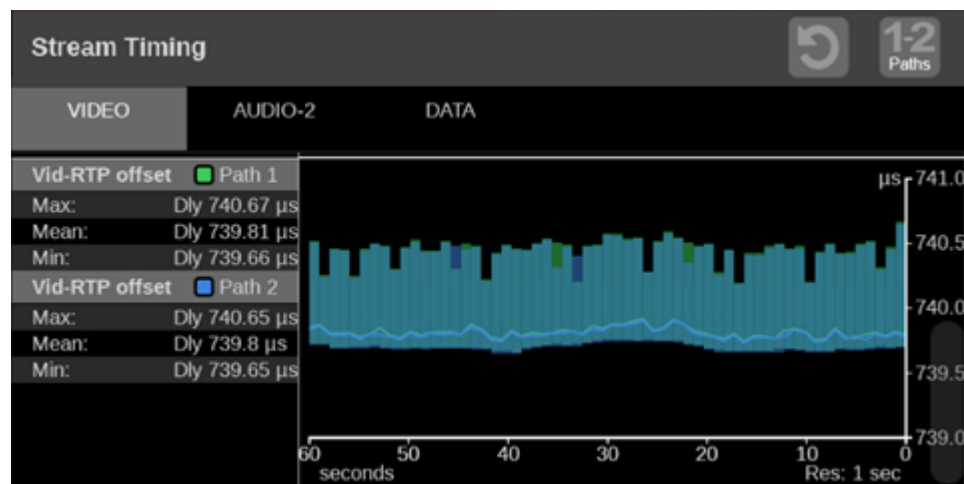

Audio Offset Tab

This tab has options to see the timing and data between the audio stream and video stream or RTP offset.

Aud-Vid Offset

The graph shows the relative delay between audio and video streams. This value indicates the amount of delay that must be applied to realign the signals according to the timestamps.

Note: The selected stream is indicated in the Audio tab as <1-4>.

Note: The audio measurements are logged to a single graph. If you change the audio stream being monitored, we recommend resetting the graph to only see the measurements relative to the current stream.

To change the monitored stream:

1. Select the **Tile** icon () and select the Audio menu.
2. Select the stream to monitor.

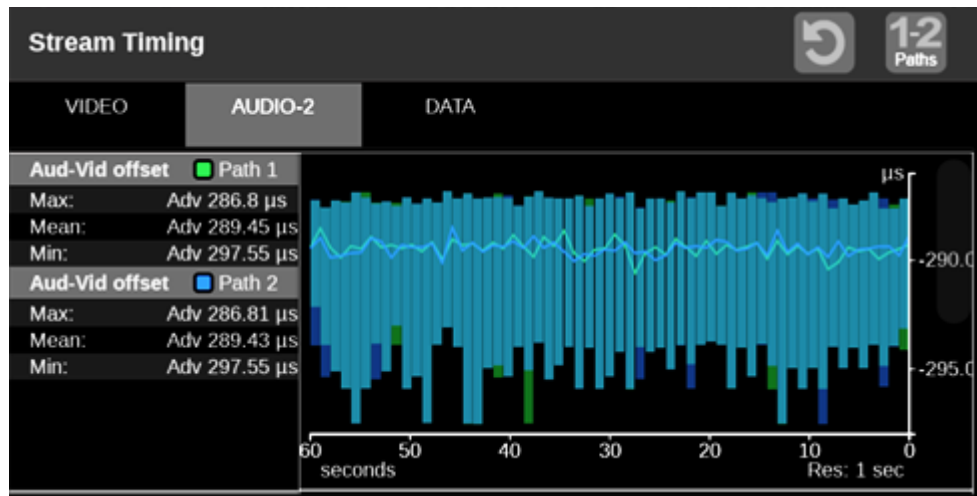

Aud-RTP Offset

The graph shows timing of the audio stream as it was received relative to the embedded RTP timestamps.

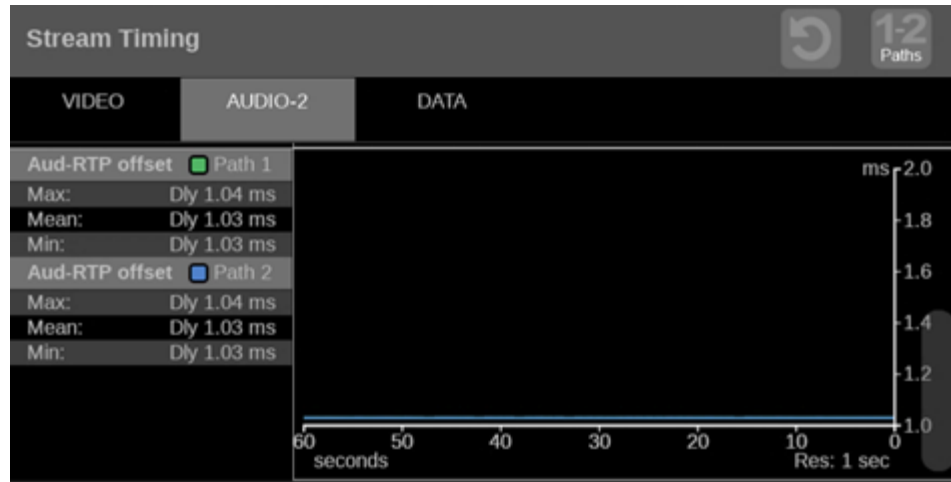

Data Offset Tab

This tab has options to see the timing and data between the data stream and video stream or RTP offset.

Data-Vid Offset

The graph shows the relative delay between data and video streams. This value indicates the amount of delay that must be applied to realign the signals according to the timestamps.

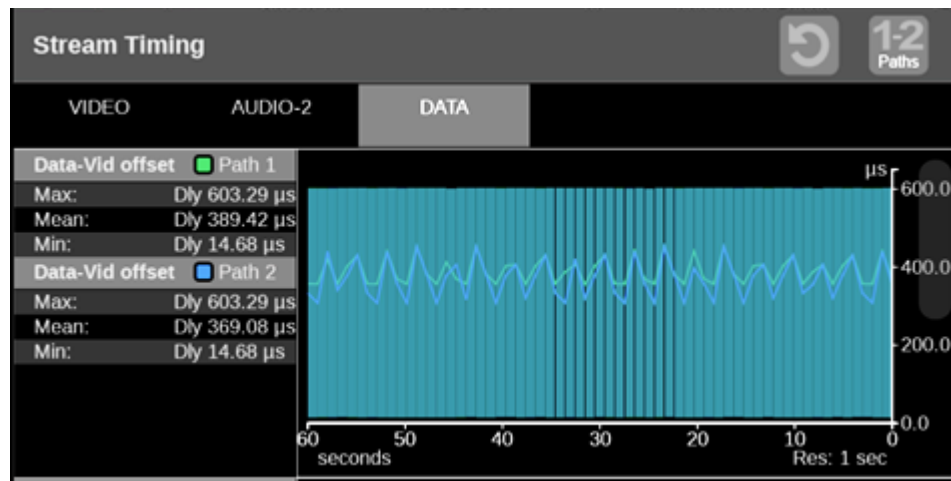

Data-RTP Offset

The graph shows timing of the data stream as it was received relative to the embedded RTP timestamps.

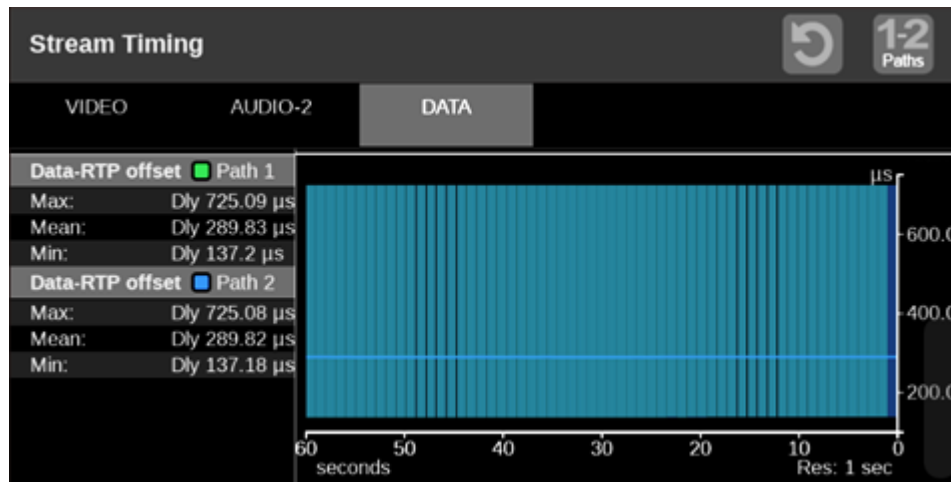

ANC (Ancillary Data) Session Application

Note: In multi-input mode, ANC Session only works with the primary channel.

The ANC Session application allows you to examine all the ancillary data present in a signal. The instrument continually monitors the signal and tells you when changes in the presence of data occur.

Select the Clear icon (🔄) to reset the monitoring session for both the WATCH LIST and the SCTE104 pages.

Note: PRISM monitors the first 4 links of the 8 logical SDI links in Quad Link 3G LB and Quad Link 12G.

NAME	DID	SDID	LINK	LOCATION(S)	OCCURRENCE	NOTE
✓ S352M VPID	41	1	C	Line 10 Sample 1939	Field	89 ca 00 01
✓ Type 2	42	1	C	Line 10 Sample 1928	Field	
✓ S352M VPID	41	1	Y	Line 10 Sample 1939	Field	89 ca 00 01
✓ Type 2	42	1	Y	Line 10 Sample 1928	Field	
✓ S299-1 Ctrl Grp 1	E3	--	Y	Line 9 Sample 1928	Field	48kHz PP-- Frn

Note: A green checkmark in the WATCH LIST name column means data is being continuously received. A yellow exclamation mark means data has been received but it has stopped.

WATCHLIST Tab

Watchlist tab provides a list of the detected ANC data. It also reports the last detected time, so an infrequent ANC data, such as SCTE-104, can be monitored in the Occurrence column. The Line/Sample information, in conjunction with Datalist display, helps you diagnose the ANC data at the bit level.

DID: Data identifier of the packet, permissible values range from 1 to 0xFF (255) inclusive.

SDID: Secondary data identifier of the packet, permissible values range from 0 through 0xFF (255) inclusive.

LINK: This is the virtual link or stream the ANC data is present on.

LOCATION(S): This is the transport line number the ANC data is present on.

OCCURRENCE: Shows the last time a packet occurred.

NOTE: Shows the basic information about the ANC data, like time code or summary of SCTE104.

SCTE104 Tab

The SCTE104 tab displays the Multiple Operations messages, and RTC / TC displays the reception time of the ANC packets with SCTE104 data. The user can review up to the last 10 messages to check the message sequence is correct.

Select the run button (▶) to start the data stream.

Select the pause button (⏸) to pause the data stream.

Note: When the run button (▶) is visible, it means data monitoring-collecting is paused. When the pause button (⏸) is visible, it means data collecting-monitoring is running.

Multiple Operation codes and the titles

Op code	Op title
0x0101	splice_request_data()
0x0102	splice_null_request_data()
0x0104	time_signal_request_data()
0x0109	insert_DTMF_descriptor_request_data()
0x010A	insert_avail_descriptor_request_data()
0x010B	insert_segmentation_descriptor_request_data()
0x010C	proprietary_command_request_data()

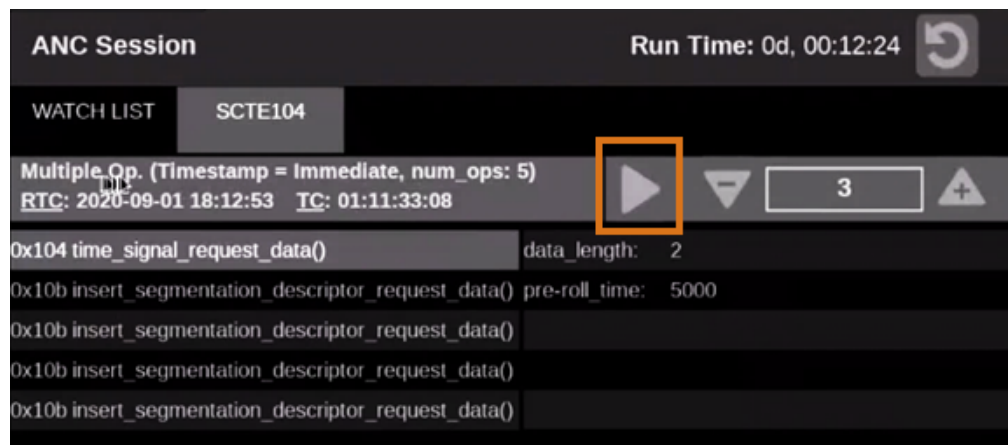

Note: The RTC (real-time clock) and TC (time code) numbers in the SCTE104 page match the RTC and TC in the PRISM status menu.

The number in the left column of the SCTE104 page is the number of operations received. Select the Plus icon (⊕) or Minus icon (⊖) to scroll through the list of up to the last 10 received messages.

Received messages that are marked as duplicates (ST2010 header of 0x09) will display "Duplicate" instead of Multiple or Single Operation. "Duplicate" is also marked in the Event Log.

Datalist Application

Note: In multi-input mode, Datalist only works with the primary channel.



Datalist allows you to see the digital data contained in SDI frames for HD, 3G Level A, and single link 12G formats so you can perform in-depth monitoring and analysis of incoming SDI data. 4K Quad Link signals can be monitored by looking at the individual links as separate inputs.

Note: Datalist requires software option MP2-ENG or MP2-QC.

Note: Deep color is not supported in the Datalist application. All other SDI applications support deep color.

Note: SD-SDI is not supported in Datalist.

Note: The display readouts only display when the tile is expanded to full screen.

The half-screen icon () expands the tile vertically. If the tile expands, it covers the tile above or below, depending on whether you are expanding the top or bottom tile. The reduce icon () turns the tile to quarter-screen size.

The Datalist display shows the digital data from the selected SDI input. It is updated approximately once per second and updating can be controlled by the Run/Pause button in the application banner.

While the application is running or paused, you can scroll through the SDI data using a touchscreen or mouse. Scroll vertically by touch-swipe or use the mouse scroll wheel. Scroll horizontally by touch-swipe or click-and-drag with the mouse. Alternately, the described navigation controls can be used.

Select the question mark icon (?) to show the color map for the various types of data.

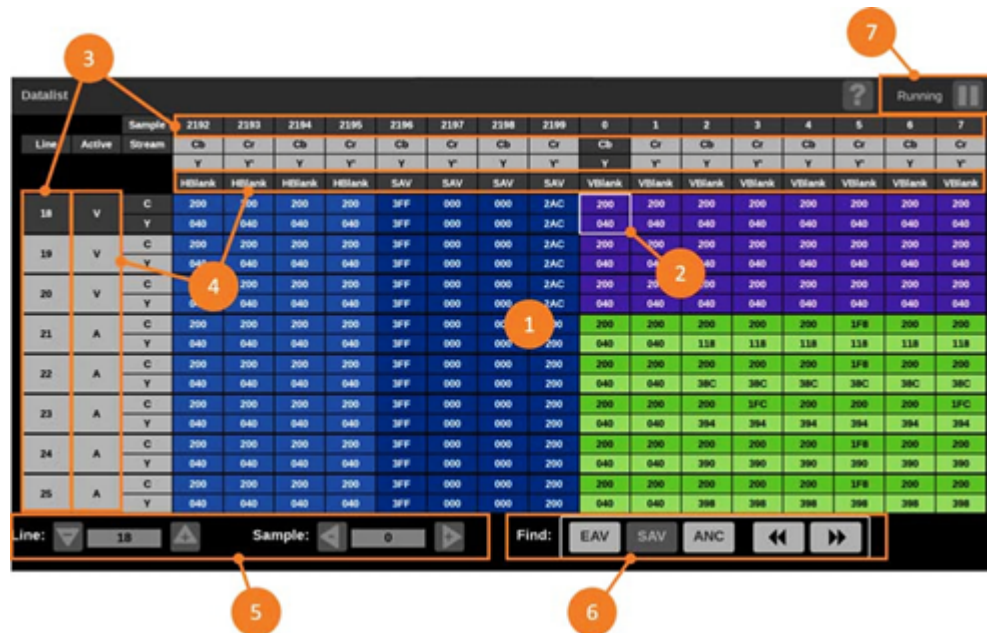

Item	Description
1	SDI frame data: The SDI frame data is color coded for easier identification. Select the ? key in the application banner for help in decoding the SDI data types.
2	Selected SDI sample: The SDI sample that is selected by the Line and Sample controls at the bottom of the application.
3	Line and sample numbers
4	Line and sample data types
5	Line and sample selection: Use these controls to go to a specific sample and line. The number can be entered directly by selecting the current number; this displays a keyboard. Enter the line or sample number and select Enter to go to that location.
6	SDI frame shortcuts: Use these controls to go to the next EAV, SAV, and ANC location after the selected SDI sample. For example, to go to the next SAV location, select the SAV button and then select the fast forward button.
7	Run/Pause control: Select this button to run and pause the SDI frame updates. Pausing allows you to examine a single SDI frame in more detail.

Timing Application

Note: In multi-input mode, Timing only works with the primary channel.

The Timing application uses a reference to evaluate the timing of the input of single-link SDI, quad-link SDI, or IP formats (ST 2022-6 or 2110-20). The timing of the input is compared to the expected frame time according to the reference alignment.

SDI versus Black Burst is available in standard. SDI versus PTP, IP versus PTP, Black Burst versus PTP requires Option MP2-IP-MEAS.

For analog references (Black Burst or Tri-Level sync) the relative position of the horizontal and vertical sync pulses are compared to the input signal. In the case of PTP the current time is obtained and compared to the SMPTE Epoch. When an input is configured for ST 2022-7 style redundant streams, circles for Path 1 (green) and Path 2 (blue) appears, otherwise only a single path displays. When the input signal is fully aligned with the reference, both circles are in the center of the display indicated by the + symbol.

Note: PTP must be locked to use the Timing application with PTP references.

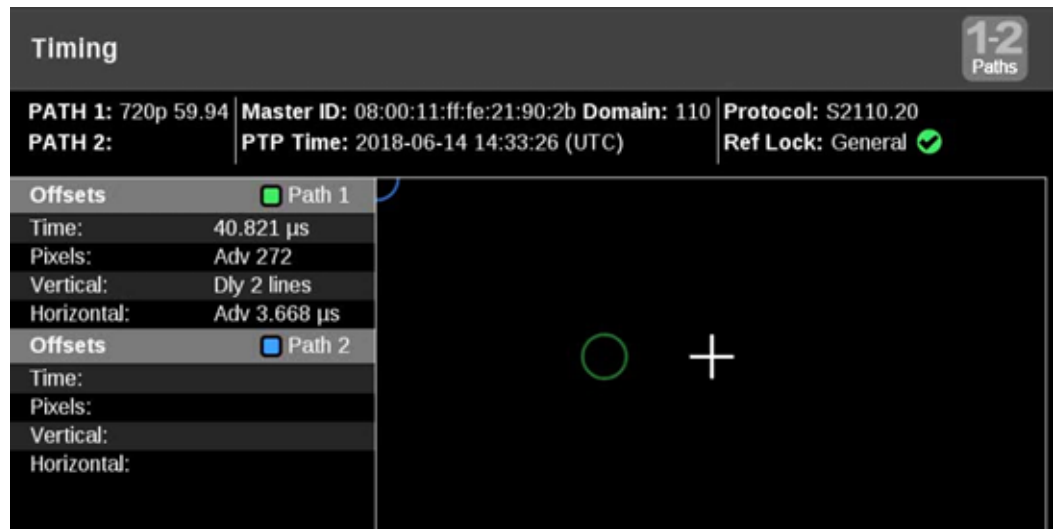

Timing Settings Menu

Open the Timing Settings menu:

1. Select the **Tiles** icon ().
2. Select the tile with the Timing application.

3. Select the **Tile** icon ().

Note: The Move icon () is in the settings menu header. Select this icon to move the settings left or right.

Use the menu to change the measurement mode between options.

Video to Reference: The input video signal (SDI or IP) is compared relative to the reference input (analog or PTP).

Analog to PTP: Used in a hybrid system to compare the analog reference to the PTP reference to ensure synchronization.

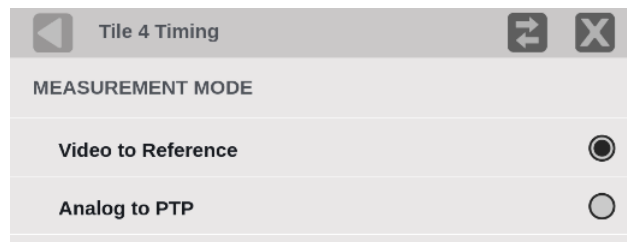

Compare Analog Reference with PTP

1. If not already done, choose the Setting References. See [Choose External Reference](#).
2. In the Timing Settings menu select **Analog to PTP**.

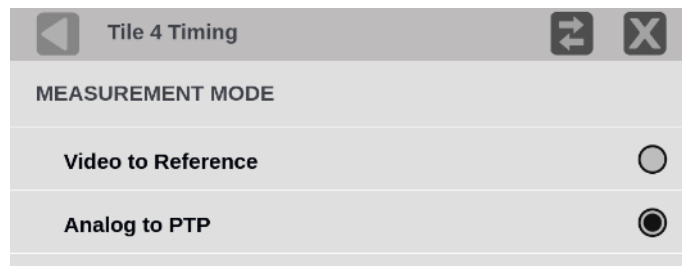

The Timing application compares the Analog to PTP.

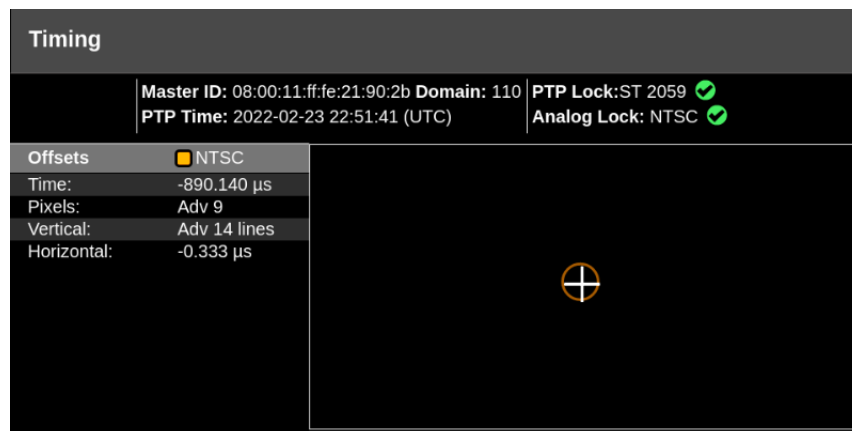

Elements of Timing Display



Path 1 and **Path 2**: Displays the IP video format if an IP input signal is selected.

Note: You can switch between Path 1, Path 2, or both Path 1-2 using the Path button at the top right of the application display.

Master ID and **Domain**: Displays the reference Source and Domain.

PTP Time: Time of day derived from the PTP signals.

Protocol: Displays the input protocol.

Ref Lock: A  (check in green) indicates the PRISM is locked to the reference. A  (x in red) indicates the PRISM is not locked to the reference.

Reference Indicator: A crosshair indicator centered in the display represents the reference signal.

Circle: The circle represents the timing of the input signal. A signal that is early is above or to the left of the crosshair. A signal that is late is below or to the right.

Offset: The difference in timing between the input and reference. A positive number, or "delayed" value, means the input occurs after the reference. A negative number, or "advanced" value, means the input occurs before the reference.

- **Time**: The total difference in frame timing between the input and reference
- **Pixels**: The timing difference between the reference and input signal, expressed as in pixels, instead of time units, after the vertical offset has been removed. This has a range of $\pm \frac{1}{2}$ line for the input format.
- **Vertical**: The timing difference between the reference and input signal, expressed as the number of lines of delay for the input video format. This has a range of $\pm \frac{1}{2}$ field for progressive signals and $\pm \frac{1}{2}$ frame for interlace signals.
- **Horizontal**: The timing difference between the reference and input signal, expressed as the line time, which remains from the total delay after the vertical offset has been removed. This has a range of $\pm \frac{1}{2}$ a line for the input format.

Additional offset displays are available for Quad Link SDI signals.

Link Offsets: Time delays of Links B, C, and D relative to Link A. These time delays are also shown graphically under the timing display window.

Max Link Offset: Maximum time delay between any two links.

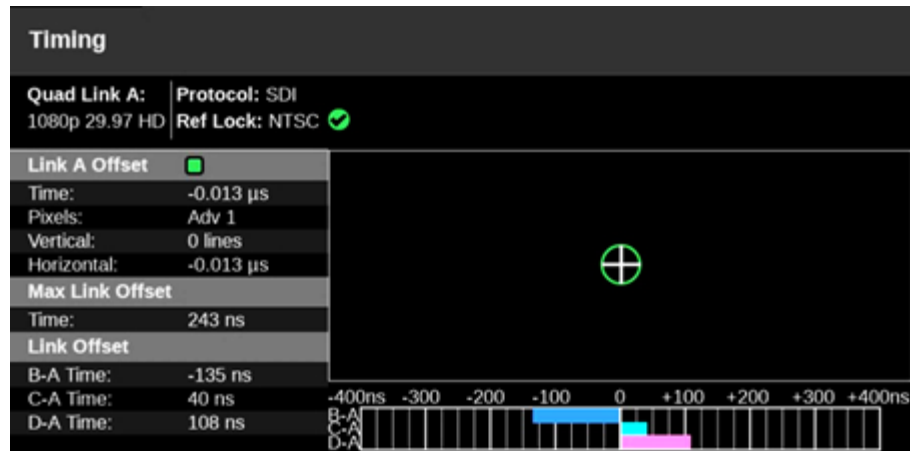

Timing Offsets for IP Signals

Because ST 2022-6 streams are complete SDI signals encapsulated in IP, the timing measurement treats these IP signals as if they were SDI. So the timing system detects the start of the IP frame, then extrapolates to the 0 h point of the encapsulated SDI. Then using PTP as the reference, the ideal alignment point for that frame rate is calculated based on the PTP epoch. Finally, the offset between the ST 2022-6 signal and the ideal alignment is displayed. The display shows both absolute time and the time parsed into lines or horizontal delay as time and pixels.

For ST 2110-20 streams, the Timing application displays the time of the first packet of the frame. Since ST 2110 does not include blanking, the first packet is nominally coincident with the first active line in the SDI raster. This means it is normal for the ST 2110 streams to be delayed by the lines in the vertical blanking of a given format. This value varies by format: HD (21 lines), 3G (42 lines), 4K/UHD (84 lines). According to ST 2110-21, both gapped and linear flows should have the start of frame delayed by the equivalent of vertical blanking.

Use Cases for Measuring Timing

One use case for the Timing application is to measure the delay in a gateway and network. If a properly timed SDI signal is applied to a gateway, then the timing measurement on the resulting IP flow displays the combined latency in the gateway and the network.

Each ST 2110 stream also carries timestamps. The Stream Timing application allows for the analysis of these timestamps.

Eye Application

Note: In multi-input mode, Eye only works with the primary channel.

The Eye application presents an eye pattern diagram of the SDI signal to verify electrical characteristics of the SDI transport layer. Use this application to make automated eye measurements on SD, HD, and 4K SDI signals.

Note: This application requires hardware Option PHY and software option MP2-FMT-4K to enable 12G-SDI. This application is only valid on SDI 1.

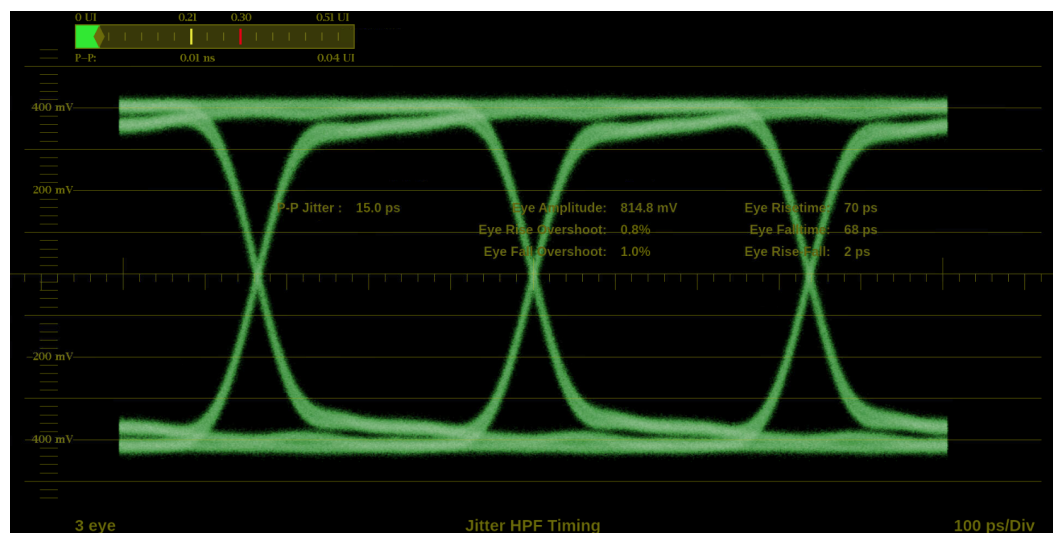

When the application is in full-screen mode, a data display is visible. The information can be moved anywhere in the tile. Select-and-drag the text to move it to a new location.

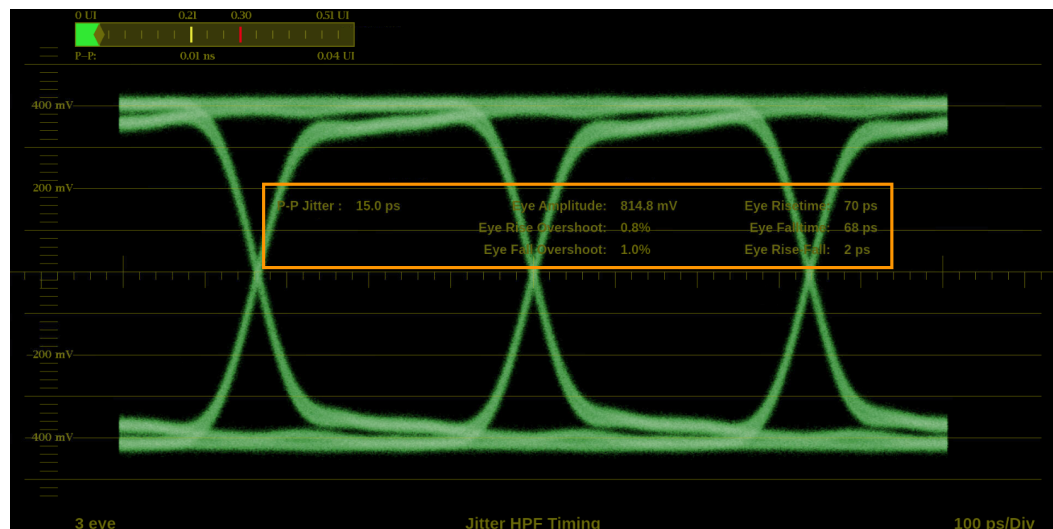

Eye Display Settings Menu

Open the Eye Display Settings menu:

1. Select the **Tiles** icon (🗄️).
2. Select the tile with the Eye application.
3. Select the **Tile** icon (⚙️).

Note: The Move icon (↔️) is in the settings menu header. Select this icon to move the settings left or right.

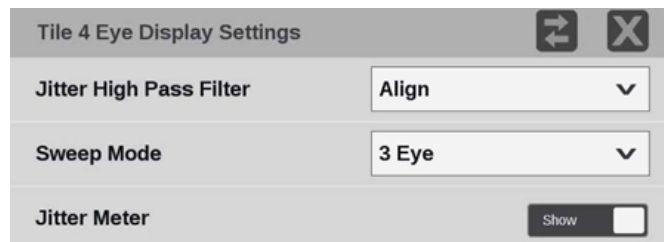

Jitter High Pass Filter

Select the menu to set the high pass filter to Timing, Align, 10 Hz, 100 Hz, 1 kHz, 10 kHz, or 100 kHz.

Note: For multi-piece displays, the filter setting applies to both pieces.

Sweep Mode

Select the menu to set to 3 Eye, 10 Eye, 1 Field, or 2 Field.

Jitter Meter

Set to **Show** to turn on the jitter meter above the eye pattern.

Eye measurements (eye amplitude, eye risetime, eye falltime, eye rise-fall, eye rise overshoot, eye fall overshoot, and P-P jitter) are displayed when the Eye application is in full-screen mode. The display can be moved by selecting and dragging it.

Jitter Application

Note: In multi-input mode, Jitter only works with the primary channel.

The Jitter Display application shows the wave shape of the jitter and allows you to view additional time-domain information, such as whether there are jitter components that are synchronous or nearly synchronous to the video line or frame.

Note: This application requires hardware option PHY and software Option MP2-FMT-4K to enable 12G-SDI. This application is only valid on SDI 1.

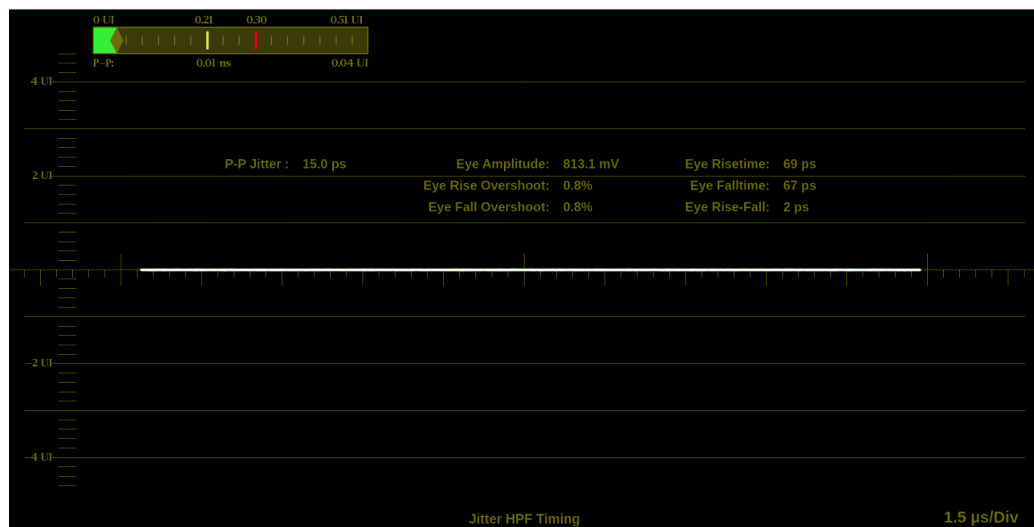

When the application is in full-screen mode, a data display is visible. The information can be moved anywhere in the tile. Select-and-drag the text to move it to a new location.

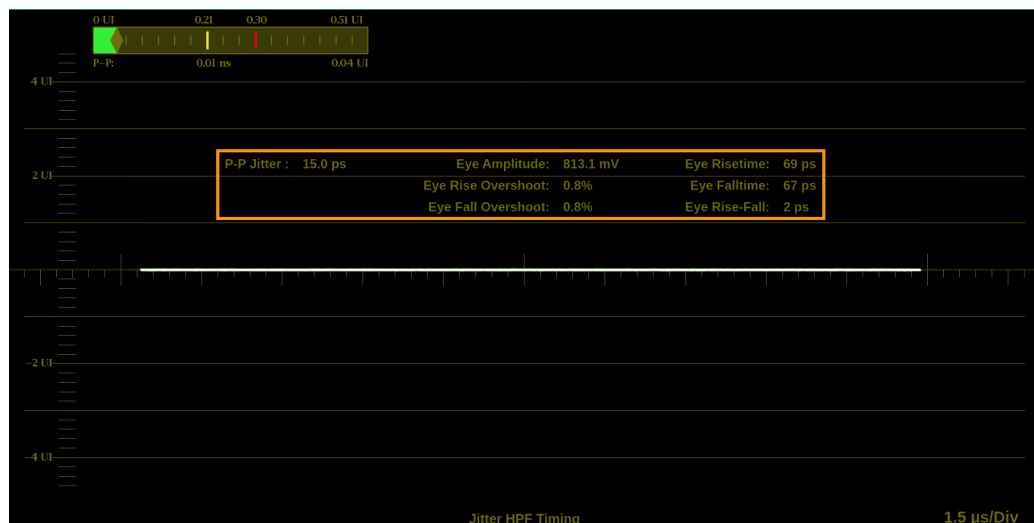

Open the Jitter Display Settings menu:

1. Select the **Tiles** icon ().
2. Select the tile with the Jitter application.
3. Select the **Tile** icon ().

Note: The Move icon () is in the settings menu header. Select this icon to move the settings left or right.



Jitter High-Pass Filter: Select the menu to set the high pass filter to Timing, Align, 10 Hz, 100 Hz, 1 kHz, 10 kHz, or 100 kHz.

Depending on the format, Timing typically uses the 10 Hz filter and Align uses the 1 kHz or 100 kHz filter.

Sweep Mode: Select the menu to set to 1 Line, 2 Line, 1 Field, or 2 Field.

Jitter Meter: Set to **Show** to turn on the jitter meter at the top of the tile.

Note: Eye measurements (eye amplitude, eye risetime, eye falltime, eye rise-fall, eye rise overshoot, eye fall overshoot, and P-P jitter) are displayed when the Jitter Display application is in full-screen mode.

Audio-Video Delay Application

The Audio-Video Delay display shows any difference between the video signal and the timing of the audio. The measurement uses the video signal as the 0 line in the display and if the audio signal is in advance or delayed of it. The thresholds for the audio occurring before or after the video can be set. If the audio signal is outside of either limit (later than the delay threshold or before the advance threshold), the display shows a yellow bar.

Note: The application can monitor up to 16 channels.

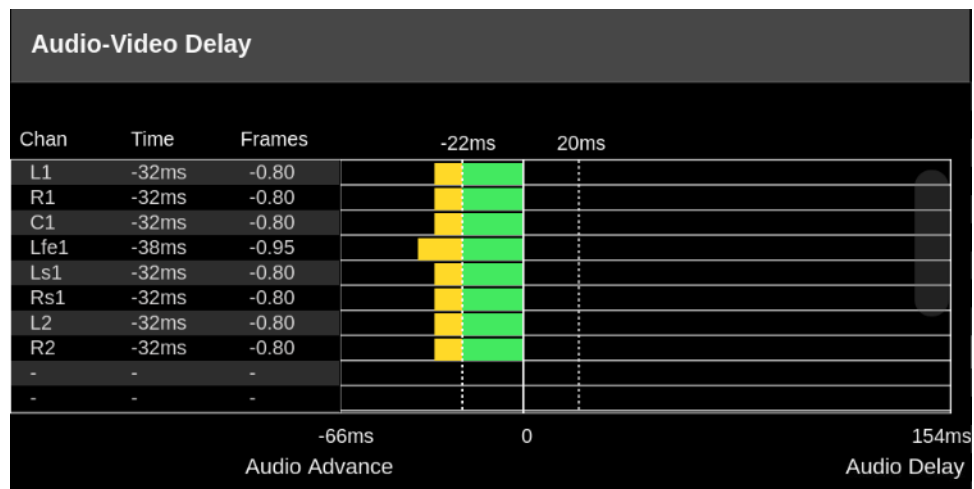

Note: This application requires a test-signal source with an AV timing mode enabled from a Telestream device such as the TG8000 or SPG8000A.

Audio-Video Delay Settings Menu

Open the Audio-Video Delay Settings menu:

1. Select the **Tiles** icon ().
2. Select the tile with the Audio-Video Delay application.

3. Select the **Tile** icon (⚙️).

Note: The Move icon (↔️) is in the settings menu header. Select this icon to move the settings left or right.

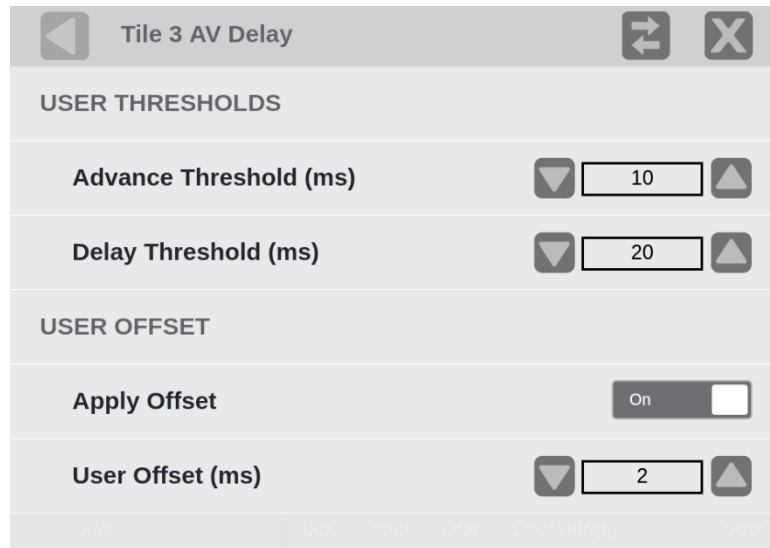

Advance Threshold

The Advance Threshold number is the time the audio test signal can arrive *before* the visual test signal arrives (to the *right* of the 0 line) and not register as an error; that is, the channel is green in the display.

To change the Advance Threshold number:

Select in the Advance Threshold field and enter the number on the keypad or select the up or down arrows.

Note: The number in the menu is shown as positive but in the display it is marked as negative, such as -22, and is only to the left of the 0 line.

Delay Threshold

The Delay Threshold number is the time the audio test signal can arrive *after* the visual test signal arrives (to the *right* of the 0 line) and not register as an error; that is, the channel is green in the display.

To change the Delay Threshold number:

Select in the Delay Threshold field and enter the number on the keypad or select the up or down arrows.

Apply Offset

The User Offset allows moving the 0 line in advance or delay of the visual test signal arrival.

Set the Apply Offset to **On** to turn on the offset. The offset setting is visible in the upper right of the tile.

To change the Apply Offset number:

Select in the Apply Offset field and enter the number on the keypad or select the up or down arrows.

- A positive number in the field moves the 0 line to the *left* of the incoming signal, so the signal arrives in advance. The Time and Frames measurements are positive.
- A negative number in the field moves the 0 line to the *right* of the incoming signal, so the signal arrives delayed. The Time and Frames measurements are negative.

The example shows an offset of 10 ms Advanced, making the correctly timed visual test signal appear to arrive 10 ms early.

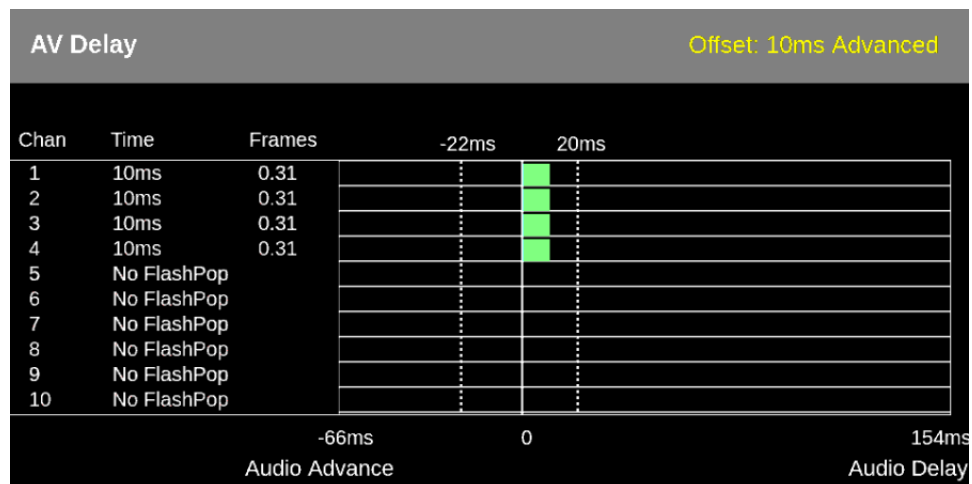

IP Generator Application

The IP Generator application provides ST 2110 -20/-30 with ST 2022-7 test signals which can be used to check the receiver device and the signal path.

Note: The IP Generator application requires Option MP2-GEN

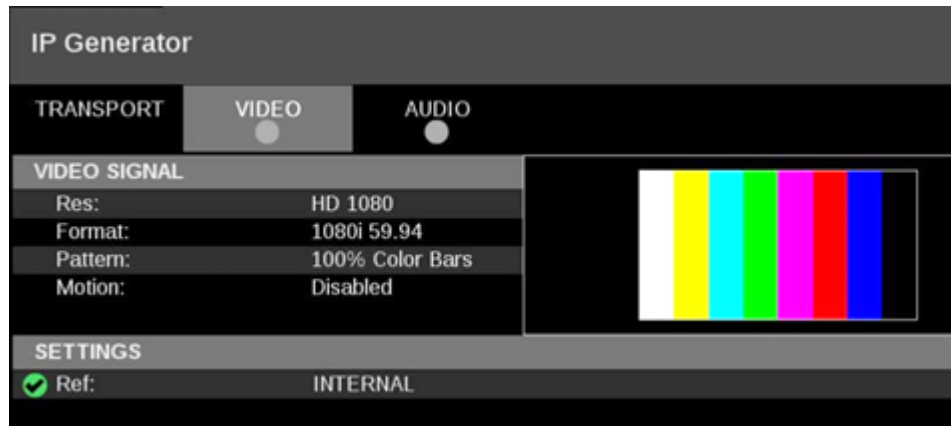

IP Generator Settings Menu

Open the IP Generator Settings menu:

1. Select the **Tiles** icon ().
2. Select the tile with the IP Generator application.

3. Select the **Tile** icon (⚙️).

Note: The Move icon (↔️) is in the settings menu header. Select this icon to move the settings left or right.

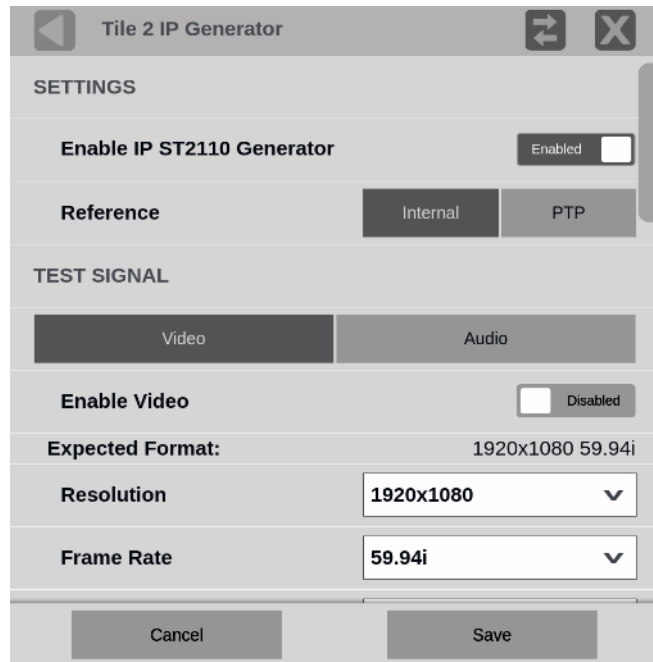

Enable IP ST2110 Generator

Set Enable IP ST2110 Generator to either Enabled or Disabled.

Reference

Select to set the IP Generator reference to either Internal or PTP.

TEST SIGNAL

Select the test signal option: [Video](#) or [Audio](#).

Video

This section explains the options for setting up the video test signal.

Enable Video

This control enables and disables the test signal video.

Expected Format

This lists the selected Resolution, Frame Rate, and Structure settings.

Resolution

Select the menu to choose a resolution: 525i, 625i, 1280x720, 1920x1080, 2048x1080, 3840x2160, 4096x2160.

Frame Rate

Select the menu to choose the frame rate (only the frame rates available for the selected format appear):

59.94i: available for resolution 525i.

50i: available for resolution 625i.

23.98p, 24p, 25p, 29.97p, 30p, 50p, 50i, 59.94p, 59.94i, 60p, and 60i: available for resolution 1920x1080.

23.98p, 24p, 25p, 29.97p, 30p, 50p, 59.94p, and 60p: available for all other resolutions.

Note: The resolution 4096x2160 is limited to a maximum frame rate of 50p if the Video IP Port Data Rate is set to 10Gb.

Structure

Select the menu to choose YCbCr 4:2:2 10bit or RGB 4:4:4 12bit (for supported Resolution and Frame rates, and for matching receiver, see [Supported video formats in ST 2110-20 streams](#)).

Pattern

Select the menu to choose from the patterns: Black or 100% Color Bars.

Motion

This control enables or disables horizontal motion of the color bars.

Note: The Motion option is unavailable when Pattern is set to Black.

Packing Mode

Select one of these packing modes:

Block: Block Packing Mode is based on 180-byte blocks and supports many formats.

General: General Packing Mode follows the open packing standards of RFC 4175.

RTP Payload Type

Select in this field to set the generated IP stream to an RTP Payload Type number between 96 and 127.

Note: Each generated IP stream must have a unique RTP Payload Type number.

Packet Read Schedule (PRS)

Select one of these read schedules:

Gapped: Gapped PRS reads packets at an equally spaced sequence throughout the active field or frame interval and accounts for vertical blanking (gaps).

Narrow (Linear): Narrow (linear) PRS reads the packets at an equally spaced sequence throughout a video frame.

VIDEO PORT SFP+ 1 and SFP+ 2

1. Set VIDEO PORT SFP 1 and VIDEO PORT SFP 2 to Enabled or Disabled as needed.
2. For enabled ports, enter addresses into the Destination Addr. and Destination Port fields.

When enabled and the fields are filled in, each port is automatically configured.

Note: The Source IP Address, Source Port, Source MAC Address, and Destination MAC Address are automatically configured based on the Destination Address and Destination Port.

VIDEO PORT SFP 1	Enabled <input type="checkbox"/>
Source IP Address	172.22.198.67
Source Port	<input type="text" value="50020"/>
Source MAC Address	00:90:56:08:2b:a7
Destination Addr.	<input type="text" value="239.26.198.138"/>
Destination Port	<input type="text" value="50020"/>
Destination MAC Address	01:00:5e:1a:c6:8a

Audio

This section explains the options for setting up the audio test signal.

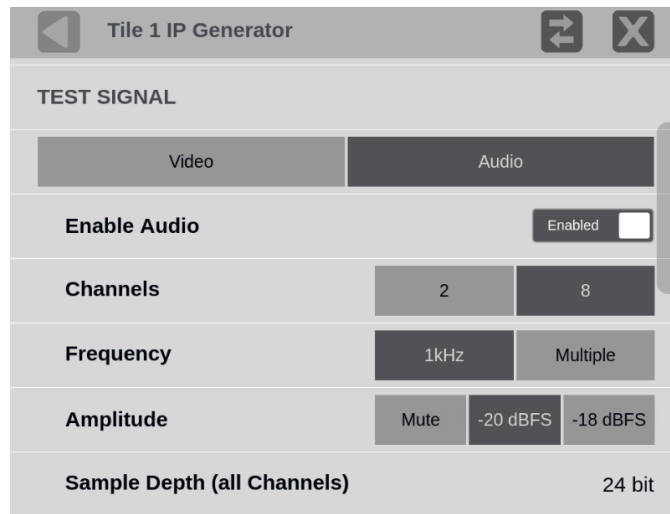

Enable Audio

Set the audio test signal enable or disable.

Channels

Select either 2 or 8 channels.

Frequency

Select 1-kHz or Multiple.

Amplitude

Select from the options:

Mute: always available

-20 dBFS: available when Frequency is set to 1 kHz

-18 dBFS: available when Frequency is set to 1 kHz

Multiple: available when Frequency is set to Multiple

Sample Depth (all Channels)

This setting lists the sample depth of all channels.

The Multiple settings with Amplitude... table shows the audio test signal values in each channel when both Frequency and Amplitude, in the settings menu, are set to Multiple.

Multiple settings with Amplitude and Frequency levels per channel

Channel	Amplitude (dBFS)	Frequency (Hz)
1	-18	240
2	-22	480
3	-20	360
4	-28	120
5	-24	600
6	-26	1200
7	-30	1800
8	-32	2400

Packet Time

Select 125 μ s or 1 ms packet times.

RTP Payload Type

Enter an RTP Payload Type number for the generated IP stream.

Note: Each generated IP stream must have a unique RTP Payload Type number.

AUDIO PORT SFP+ 1 and SFP+ 2

1. Set AUDIO PORT SFP 1 and AUDIO PORT SFP 2 to Enabled or Disabled as needed.
2. For enabled ports, enter addresses into the Destination Addr. and Destination Port fields.

When enabled and the fields are filled in, each port is automatically configured.

Note: The Source IP Address, Source Port, Source MAC Address, and Destination MAC Address are automatically configured based on the Destination Address and Destination Port.

- When all the needed elements in the IP Generator menu have been selected or set, select **Save**.

Elements of IP Generator Display

Display tabs provide information regarding the generated IP streams. Select one of the tabs to view the associated display.

TRANSPORT Tab Display

Select TRANSPORT to view the status of the generated IP streams.

IP Generator						
TRANSPORT		VIDEO	AUDIO			
STREAM	PORT	PAYLD	DEST IP	SOURCE IP		D
● S2110.20 P1	SFP1	96	239.20.54.17:50020	172.21.54.17:50020		0
● S2110.20 P2	SFP2	96	239.20.54.17:50020	172.22.54.17:50020		0
● S2110.30 P1	SFP1	97	239.30.54.17:50030	172.21.54.17:50030		0
● S2110.30 P2	SFP2	97	239.30.54.17:50030	172.22.54.17:50030		0

VIDEO Tab Display

Select VIDEO to view the settings of the generated video stream.

The screenshot shows the IP Generator application interface with the VIDEO tab selected. The interface is divided into several sections:

- IP Generator** (Title)
- TRANSPORT**, **VIDEO** (selected), **AUDIO** (Navigation tabs)
- IP Generator** (Section Header)
- TRANSPORT**, **VIDEO** (selected), **AUDIO** (Navigation tabs)
- AUDIO SIGNAL** (Section Header)
- Table:**

	Chan	Amp (dBFS)	Freq (Hz)
Channels: 8	1	-20	1000
Freq: 1 kHz	2	-20	1000
Amp: -20 dBFS	3	-20	1000
Depth: 24 bits	4	-20	1000
	5	-20	1000
	6	-20	1000
	7	-20	1000
	8	-20	1000
- SETTINGS** (Section Header)
- Ref:** INTERNAL

SDI Generator Application

The SDI Generator application provides SDI video signals that can be used to check the receiver device and the signal path.

Note: The SDI Generator application requires Option MP2-GEN.

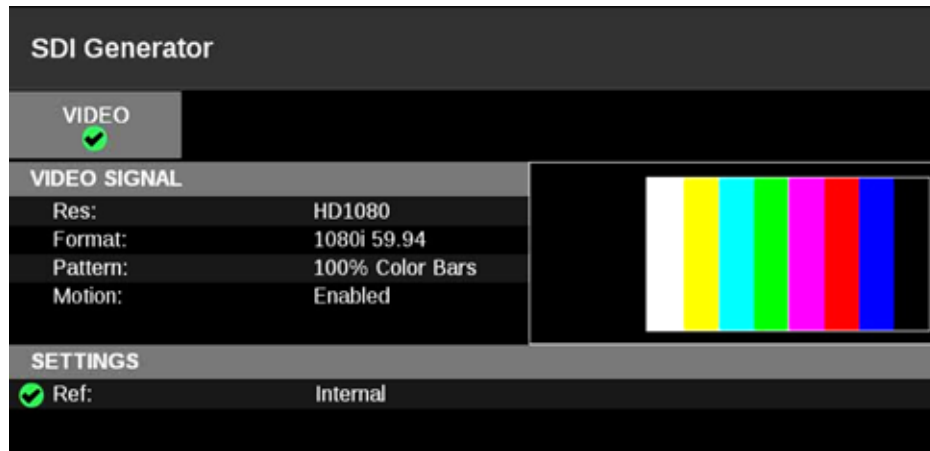

SDI Generator Settings Menu

Open the SDI Generator Settings menu:

1. Select the **Tiles** icon ().
2. Select the tile with the SDI Generator application.

3. Select the **Tile** icon (⚙️).

Note: The Move icon (↔️) is in the settings menu header. Select this icon to move the settings left or right.

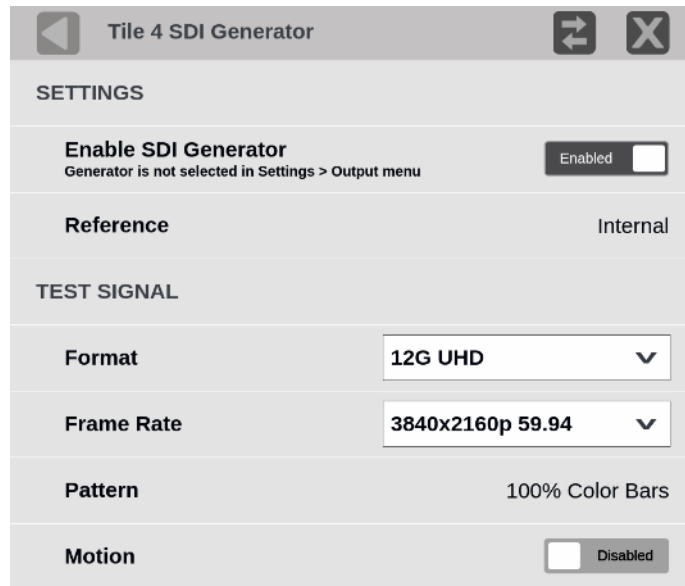

Enable SDI Generator

Select to set the SDI Generator to Enabled or Disabled.

Reference

The SDI Generator uses an internal reference.

Format

Select the menu to choose the format: SD, HD 720, HD1080, 3G LevelA, 3G LevelB, 6G UHD, 12G UHD.

Frame Rate

Select the menu to choose the frame rate (only the frame rates available for the selected format appear):

- 525i 59.94:** for format SD only
- 625i 50:** for format SD only
- 720p 50:** for format HD 720 only
- 720p 59.94:** for format HD 720 only
- 720p 60:** for format HD 720 only
- 1080i 50:** for format HD 1080 only
- 1080p 50:** for format 3G LevelA or 3G LevelB only

1080i 59.94: for format HD 1080 only

1080p 59.94: for format 3G LevelA or 3G LevelB only

1080i 60: for format HD 1080 only

1080p 60: for format 3G LevelA or 3G LevelB only

3840p 23.98: for format 6G UHD only

3840p 24: for format 6G UHD only

3840p 25: for format 6G UHD only

3840p 29.97: for format 6G UHD only

3840p 30: for format 6G UHD only

3840p 50: for format 12G UHD only

3840p 59.94: for format 12G UHD only

3840p 60: for format 12G UHD only

Pattern

The only pattern available is 100% Color Bars.

Motion

Select to enable or disable horizontal motion of the color bars.

Elements of SDI Generator Display

Select the **VIDEO** tab to view the settings of the generated SDI stream.

SDI audio and data generation is not yet available.

PTP Operational Overview

This section provides an overview of PTP network operation. Not all of the functionality described is currently available in the PRISM monitor.

PTP Introduction

This describes how a PTP master is chosen, with some description of the priorities. It also explains some of the relationship between the potential devices.

PTP Master Selection

In a PTP network, all the masters on the network are evaluated by the Best Master Clock Algorithm (BMCA). The BMCA runs on all devices, and chooses a master based on several parameters. Some of the parameters relate to clock quality; conversely the Priority 1 and Priority 2 parameters are set by the user to influence the choice of a master:

Note: The PRISM monitor has no role in setting the priority parameters or in providing information to the BMCA.

- **Priority 1:** This parameter defines which clocks are allowed to be considered as masters. To be considered as a master, the value should be set to 128 or less. Priority 1 is the first criteria in the BMCA, so if Priority 1 is set to a lower value than other devices on the system, then it is chosen even if the clock quality is poor. Typically, all the masters in a domain should have the same value for the Priority 1 parameter.
- **Priority 2:** This parameter is used to break the tie between masters that have the same clock quality. Several values may be used to define a hierarchy of devices. Most profiles use 128 as a default, so a value of 127 or lower would indicate a preferred master.
- The final tie-breaker in the BMCA is the clock ID. This is usually the MAC address so it provides a unique value by which the BMCA can choose.

Network Topology

In a typical IEEE1588 PTP network, many devices may be either masters or slaves. If the current master stops working, all the devices that are capable of being a master broadcast their clock quality and a new master is selected.

For video networks it may make sense to depart from the telecom-style PTP topology and dedicate devices to be only masters or slaves. This is the approach supported by the PRISM monitor, which allows for a more traditional primary and backup master structure controlling a range of slave devices. The BMCA is still used to select the active master and the network still takes the place of the ECO in the legacy Black-burst/Tri-level network. The PRISM monitor is a slave-only device.

Five Basic PTP Timing Messages

This section describes the five basic timing messages in a PTP system. Other messages are present in some instances. For example, grant requests and responses appear in

unicast systems, and Type Length Value (TLV) management messages appear in ST 2059 profile systems.

Announce Message

The Announce message is sent by the master to advertise its capability. This message contains the clock quality and priority settings needed for the BMCA to evaluate which device is the best master.

Sync Message

The Sync message is sent by the master and is used to measure the propagation delay from the master to slave. The sync message may contain the timestamp indicating when it was sent, or that time may be in the Follow-up message. The receiver must add a timestamp to the sync message upon receipt. These two timestamps are usually called t1 and t2 and provide the first delay measurement.

Follow-up Message

The Follow-up message is sent only in cases where the PTP network hardware is not capable of inserting the timestamp or corrections into the Sync message. (See [One-step and Two-step Operation](#).)

Delay Request Message

The Delay request is sent by the slave. The time it is sent is noted by the slave but is not included in the message. This time is usually called t3. When the delay request is received by the master, the master timestamps the receive time. This timestamp is usually called t4.

Delay Response Message

The Delay response is sent from the master to the slave. The response contains the t4 timestamp from when the master received the delay request. After the slave receives the delay response, it has the second pair of timestamps needed to calculate the second delay measurement of the slave to master delay.

Message Timing

The example shows the relationships between the five PTP timing messages.

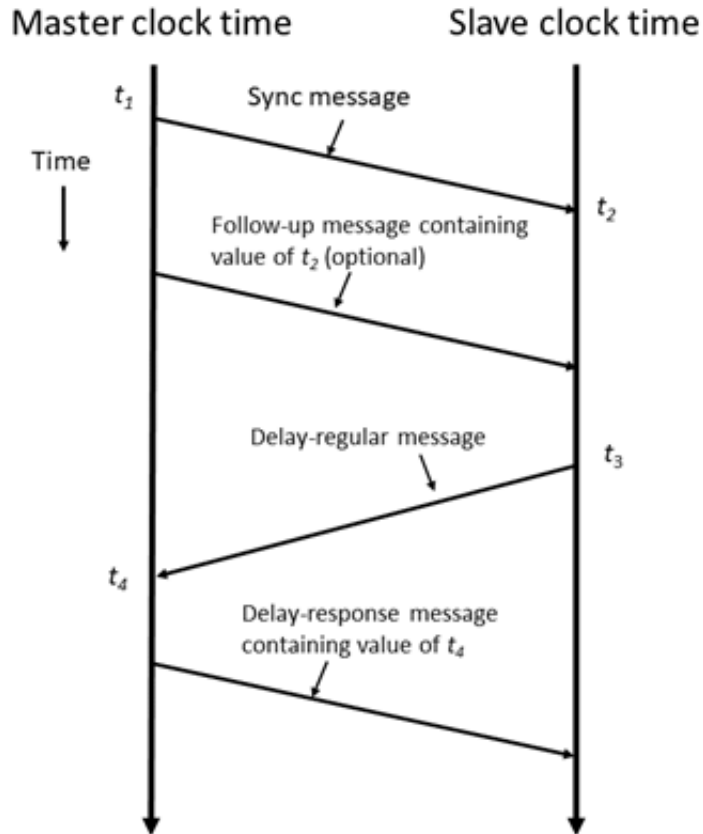

Profiles and Domains

Multiple domains and profiles can coexist on the same network.

Profiles

The IEEE1588 standard defines multiple parameters, such as the rates for Sync and Announce messages, and optional functions such as grandmaster clusters. Specific industries wanting to use PTP are encouraged to define their own “profile,” which allows the PTP standard to be tuned for specific applications. The profile defines the default and range of each parameter, and defines which options are required, allowed, or prohibited.

In the PRISM monitor, the user should select the PTP profile (General, ST 2059, or AES67). The user can then modify the profile parameters and save as part of an instrument preset. The allowed range of the parameters is restricted to that which is allowed for the selected profile type.

Domains

The IEEE1588 standard defines “domains,” which allow multiple PTP services to coexist simultaneously on one physical Ethernet connection. For example, on a given network one master and several slaves can be using domain 0 while a second master and other slaves are using domain 1. These two PTP services are independent. One use for this is to have masters on different domains provide PTP on different profiles. For example, domain 0 might be an AES67 profile, domain 1 could be a master using the AVB (802.1AS) profile, and domain 127 could be a master on the ST 2059 profile.

One-step and Two-step Operation

Some PTP messages have a timestamp associated with them. This timestamp indicates the time of the local clock when the message was sent or received. In some cases, the hardware is capable of embedding the timestamp in the message as it is sent. This is known as “one-step” mode because the message and its associated time are sent together.

In other cases, the hardware is not capable of inserting the time into the message, so instead it is sent in a second Follow-up message. This is called “two-step” mode because there are two messages.

Be aware that in End-to-End mode, only the Sync message is affected by the one-step and two-step setting because it is the only message that needs the transmit timestamp inserted. In a similar fashion, Peer-to-Peer mode has some messages that may require follow-up support.

The IEEE1588 standard specifies that all slaves are required to operate with either one-step or two-step message types. One type of device that often requires two-step operation is a Transparent Clock, because it has to calculate the residence time of a message and insert that time into the message or the follow-up message.

Multicast, Unicast, and Mixed Communication Modes

There are three basic message modes for PTP: Multicast, Unicast, and mixed Multicast and Unicast. For full Multicast or Unicast modes, all of the PTP messages are sent in the selected mode type.

For some profiles, such as some telecom profiles and the ST 2059 profile, a mixture of Multicast and Unicast are allowed. On the SMPTE profile unique mixed mode, the Announce and Sync messages are sent as multicast. However, the Delay Request and Delay Response messages are sent as Unicast.

Some points to understand about communication modes:

- Whatever mode is chosen, the master and slave must match or be compatible.
- Multicast and Mixed mode may need IGMP joins and leaves.
- Full Unicast must have the master address in all slave AMTs.
- Unicast without negotiation does not allow master to regulate load.
- Two masters can be used on different domains to serve slaves on different communication modes.

All of the master and slave devices on a given domain must use compatible communication modes. For most profiles, this means the master and slave communication modes need to match exactly. On the SMPTE profile, the Multicast and Mixed modes are compatible, so a master in any of these modes should work with a slave in any of those modes.

Multicast System Messages

Multicast messages are broadcast and so they can be received without knowing the address of the sender. This allows a slave to hook up to the network, receive the announce messages and discover the identity of the master. Multicast in some networks requires the devices to use IGMP to join and leave the multicast group.

In Multicast PTP systems, the master sets the rate of the announce and sync messages. The master also sends the maximum allowed delay request rate in the delay response message. Ideally, the slave uses that value to set the delay request rate although some slaves set this rate independently. The delay request rate is typically the same as the sync rate but may be higher or lower.

Unicast System Messages

Unicast messages require the address of the master be entered into the Acceptable Master Table (AMT) in each slave. If there are multiple masters, the IP address for each master must be entered in the AMTs of all the slaves.

In Unicast PTP systems, the slave must have the address of the master in its acceptable master table because the slave initiates the communication with the master. The slave

sends several grant requests to the master requesting specific rates for each message type. If the master accepts the grant requests, it sends grant acknowledges. If the master denies the grant, the slave may send a new grant request at a lower rate. This process may continue for several iterations until the master and slave agree on a rate. The master and slave then start exchanging the PTP messages. If the master cannot support any of the rates requested by the slave, then the slave cannot lock to the master.

Mixed Mode System Messages

In Mixed Mode systems, some messages are Multicast and some are Unicast. For the ST 2059 profile, the Announce and Sync messages are sent as Multicast. This allows devices to discover the active master. The Delay Request messages are configured as Unicast, in some case with negotiation, and in other cases without negotiation.

SMPTE Profile System Messages

For SMPTE profile systems, a given domain must use one type of message for all Announce, Sync, and Follow-up messages. Therefore, all masters and slaves on that domain must be configured for either Multicast or they all must be configured for Unicast.

For SMPTE mixed mode, the Announce, Sync, and Follow up messages are configured as Multicast, whereas the delay requests can be Multicast, Unicast, or Unicast without negotiation. To use this combination with an SPG8000A master clock generator, set the master and slave to any of the modes: Multicast, Mixed, or Mixed without negotiation. The masters support all of the slave modes simultaneously.

BMCA Operation

The Best Master Clock Algorithm (BMCA) is used to choose the active master on the domain. This is partially explained in the introduction to this document. The BMCA operation varies somewhat as function of communication mode.

Multicast Mode

In Multicast mode, the active master sends announce messages which all other masters and slaves can receive. So all devices can evaluate the BMCA and decide on the best master. If any device detects that its BMCA rating is better than the current master, it sends an announcement and takes over as the active master.

Unicast Mode

In Unicast mode, slaves only get Announce messages if they establish a grant from the master. Therefore, each slave must set up a grant with every device in its AMT. Since the masters do not set up grants from other masters, they do not have the information to evaluate the BMCA and know if they are the active master. It is up to the slaves to evaluate the BMCA based on the Announce message they get from each master in their AMT. Each slave then decides which master is the best and then set up grants for the other message types. If slaves on a given network have a different list of masters in their AMT, then they may choose a different master.

Mixed Mode

In a ST 2059 mixed environment, the announce message is Multicast. Therefore, the BMCA can follow the Multicast conventions.

Compensating for Causes of Asymmetric Delay

Several factors can cause the PTP message delay to be different for the messages sent from the master to slave as opposed to the messages the other direction from the slave to master. Unless corrected, this propagation delay asymmetry causes an offset in the clock phase equal to $\frac{1}{2}$ the difference in the two path delays. There are several main causes of asymmetric delay:

- Rate mismatch in the ports on a switch
- Traffic mismatch on the two paths
- Message type mismatch
- Cable delay variation

This section contains suggestions on how to design the system to minimize the delay asymmetry. Alternatively, some slaves provide a way to manually enter a correction value to cancel the delay error.

Rate Mismatch

Rate mismatch in a switch causes a delay asymmetry because the switch performs a “store and forward” action on messages. This means the entire message must be stored in the buffer before it starts to be “forwarded” or sent out. For example, for a 100 Mb input and 1 Gb output, the switch must wait for the entire message to clock in at the slow rate before it can start outputting the message at the high rate. Conversely for a 1 Gbps input and 100 Mbps output, the entire packet is quickly read in at the faster rate, so then the output can start sooner but at a lower rate.

While the total time is the same for both directions, the delay on the fast-in, slow-out direction is shorter on the packets, which contain the PTP timestamps. This effect is significant on a 100-Mb to 1-Gb rate mismatch, but much less significant on a 1-G to 10-G switch since the message time at 1 Gbps is quite short. If the switch supports Transparent Clock (TC) mode, then this rate mismatch delay effect is corrected by the TC delay correction.

Traffic Mismatch

Another cause of asymmetric delay is traffic mismatch on the two paths. If there is a high percentage of traffic utilization on the master to slave path, then most of the PTP messages may be delayed significantly. If the traffic on the other direction is significantly different, then the messages on the path may not suffer the same delay.

This effect can be quite large depending on the traffic, the quality of the switch, and the number of switches in the network. To reduce this effect, a user should avoid large loading on the PTP network, use high-quality switches that avoid this delay variance, or use PTP Transparent mode switches that insert residence time information to allow the slave to correct for this delay.

Setting the Diff Serve QoS on the switch and configuring the PTP messages with an appropriate DSCP can also mitigate the effects of traffic delay.

Message Type Mismatch

Another cause of delay asymmetry is message-type mismatch. For example, if the sync message is Multicast and the delay request is Unicast, then some switches may process the messages differently and cause a differential delay. Because the SMPTE profile allows a mixed mode operation, switches should be evaluated to ensure they do not have this effect. If transparent mode switches are used, then this effect should be corrected by the slave.

Cable Delay Variation

The actual propagation delay through Category 5 cable can be significantly different in one direction versus the other direction. This can be due to the twist rate on the pairs, routing inside the sheath, material differences, etc. The PTP system is incapable of removing this effect, so the best way to prevent this is to use high-quality cable with a minimum variation in the physical propagation delay.

NMOS Specifications

This section summarizes the changes in the NMOS Discovery version 1.3.

- Added additional network data for nodes as required by IS-06.
- Deprecated mDNS announcements for nodes in registered mode.
- Replaced DNS-SD service type for registration API.
- Permit deprecated node API connection management is not implemented.
- Added explicit requirements for 501 responses when features are not implemented.
- Added support for future device and transport types.
- Permitted a sender's "manifest_href" to be null when the transport type does not require a transport file.
- Added 409 response code for registries with conflicting resources.
- Added support for signaling authorization requirements.
- Indicated the potential for source/flow attributes and caps will be defined externally in the future.
- Revised the discovery process to ignore mDNS records when unicast records are available.