



PRISM MPX2-25
SDI / IP Waveform Monitor
Installation and Safety Instructions

January 2022

071373800D

Copyright © 2022 Telestream, LLC and its Affiliates. All rights reserved. TELESTREAM is a registered trademark of Telestream, LLC. All other trade names referenced are the service marks, trademarks, or registered trademarks of their respective companies.

Telestream products are covered by U.S. and foreign patents, issued and pending. Information in this publication supersedes that in all previously published material. Specifications and price change privileges reserved.

TELESTREAM is a registered trademark of Telestream, LLC.

Contact Telestream

Telestream, LLC
848 Gold Flat Road
Nevada City, CA 95959
USA

For product information, sales, service, and technical support:
Worldwide, visit www.telestream.net/telestream-support/video/support.htm to find contacts in your area.

Warranty

Telestream on behalf of itself and its Affiliates ("Telestream") warrants that this product will be free from defects in materials and workmanship for a period of one (1) year from the date of shipment. If any such product proves defective during this warranty period, Telestream, at its option, either will repair the defective product without charge for parts and labor, or will provide a replacement in exchange for the defective product. Parts, modules and replacement products used by Telestream for warranty work may be new or reconditioned to like new performance. All replaced parts, modules and products become the property of Telestream.

In order to obtain service under this warranty, Customer must notify Telestream of the defect before the expiration of the warranty period and make suitable arrangements for the performance of service. Customer shall be responsible for packaging and shipping the defective product to the service center designated by Telestream, with shipping charges prepaid. Telestream shall pay for the return of the product to Customer if the shipment is to a location within the country in which the Telestream service center is located. Customer shall be responsible for paying all shipping charges, duties, taxes, and any other charges for products returned to any other locations.

This warranty shall not apply to any defect, failure or damage caused by improper use or improper or inadequate maintenance and care. Telestream shall not be obligated to furnish service under this warranty a) to repair damage resulting from attempts by personnel other than Telestream representatives to install, repair or service the product; b) to repair damage resulting from improper use or connection to incompatible equipment; c) to repair any damage or malfunction caused by the use of non- Telestream supplies; or d) to service a product that has been modified or integrated with other products when the effect of such modification or integration increases the time or difficulty of servicing the product.

THIS WARRANTY IS GIVEN BY TELESTREAM WITH RESPECT TO THE PRODUCT IN LIEU OF ANY OTHER WARRANTIES, EXPRESS OR IMPLIED. TELESTREAM AND ITS VENDORS DISCLAIM ANY IMPLIED WARRANTIES OF MERCHANTABILITY OR FITNESS FOR A PARTICULAR PURPOSE. TELESTREAM'S RESPONSIBILITY TO REPAIR OR REPLACE DEFECTIVE PRODUCTS IS THE SOLE AND EXCLUSIVE REMEDY PROVIDED TO THE CUSTOMER FOR BREACH OF THIS WARRANTY. TELESTREAM AND ITS VENDORS WILL NOT BE LIABLE FOR ANY INDIRECT, SPECIAL, INCIDENTAL, OR CONSEQUENTIAL DAMAGES IRRESPECTIVE OF WHETHER TELESTREAM OR THE VENDOR HAS ADVANCE NOTICE OF THE POSSIBILITY OF SUCH DAMAGES.

[W2 – 15AUG04]

TELESTREAM SOFTWARE LICENSE AGREEMENT

THE PROGRAM, OR PROGRAMS, ENCODED OR INCORPORATED WITHIN EQUIPMENT OR ACCOMPANYING THIS AGREEMENT, IS FURNISHED SUBJECT TO THE TERMS AND CONDITIONS OF THIS AGREEMENT. RETENTION OF THE PROGRAM FOR MORE THAN THIRTY DAYS OR USE OF THE PROGRAM IN ANY MANNER WILL BE CONSIDERED ACCEPTANCE OF THE AGREEMENT TERMS. IF THESE TERMS ARE NOT ACCEPTABLE, THE UNUSED PROGRAM AND ANY ACCOMPANYING DOCUMENTATION SHOULD BE RETURNED PROMPTLY TO TELESTREAM FOR A FULL REFUND OF THE

LICENSE FEE PAID. (FOR INFORMATION REGARDING THE RETURN OF PROGRAMS ENCODED OR INCORPORATED WITHIN EQUIPMENT, CONTACT THE NEAREST TELESTREAM SALES OFFICE.)

DEFINITIONS

"Telestream" means Telestream, LLC, a Delaware limited liability company, and its Affiliates, or the local Telestream legal entity that is supplying the equipment. "Program" means the Telestream software product (executable program and/or data) enclosed with this Agreement or included within the equipment with which this Agreement is packed. "Customer" means the person or organization in whose name the Program was ordered.

LICENSE

Customer may:

1. Use the Program on a single machine at any one time; and
2. Copy the Program for archival or backup purposes, provided that no more than one (1) such copy is permitted to exist at any one time. Each copy of the Program made by Customer must include a reproduction of any copyright notice or restrictive rights legend appearing in or on the copy of the Program as received from Telestream.

Customer may not:

1. Use the Program on more than one machine at any one time;
2. Transfer the Program to any person or organization outside of Customer or the corporation of which Customer is a part without the prior written consent of Telestream, except in connection with the transfer of the equipment within which the programs are encoded or incorporated;
3. Export or re-export, directly or indirectly, the program, any associated documentation, or the direct product thereof, to any country to which such export or re-export is restricted by law or regulation of the United States or any foreign government having jurisdiction without the prior authorization, if required, of the Office of Export Administration, Department of Commerce, Washington, D.C. and the corresponding agency of such foreign government;
4. Modify the Program, create derivative works, or merge the Program with another program;
5. Reverse compile or disassemble the Program for any purpose, beyond the extent that such activity is expressly permitted by applicable open source licenses or applicable law notwithstanding this limitation; or
6. Copy the documentation accompanying the Program.

For Programs designed to reside on a single-machine and support one or more additional machines, either locally or remotely, without permitting the Program to be transferred to an additional machine for local execution, the additional machines shall be considered within the definition of "single machine." For programs permitting the Program to be transferred to an additional machine for local execution, a separate license shall be required for each such machine with which the Program may be used. Title to the Program and all copies thereof, but not the media on which the Program or copies may reside, shall be and remain with Telestream or others for whom Telestream has obtained a respective licensing right. Customer shall pay when due all property taxes that may now or hereafter be imposed, levied or assessed with respect to the possession or use of the Program or this license and shall file all reports required in connection with such taxes. If the Program or any related documentation is acquired by or for an agency of the U.S. Government, the Program and documentation

shall be considered "commercial computer software" or "commercial computer software documentation" respectively, as those terms are used in 48 CFR §12.212, 48 CFR §227.7202, or 48 CFR §252.227-7014, and are licensed with only those rights as are granted to all other licensees as set forth in this Agreement.

THE PROGRAM MAY NOT BE USED, COPIED, MODIFIED, MERGED, OR TRANSFERRED TO ANOTHER EXCEPT AS EXPRESSLY PERMITTED BY THESE TERMS AND CONDITIONS. UPON TRANSFER OF ANY COPY, MODIFICATION, OR MERGED PORTION OF THE PROGRAM, THE LICENSE GRANTED HEREIN IS AUTOMATICALLY TERMINATED WITH RESPECT TO THE PARTY THAT TRANSFERS THE PROGRAM.

TERM

The license granted herein is effective upon acceptance by Customer, and shall remain in effect until terminated as provided herein. The license may be terminated by Customer at any time upon written notice to Telestream. The license may be terminated by Telestream or any third party from whom Telestream may have obtained a respective licensing right if Customer fails to comply with any term or condition and such failure is not remedied within thirty (30) days after notice hereof from Telestream or such third party. Upon termination by either party, Customer shall return to Telestream or destroy, the Program and all associated documentation, together with all copies in any form.

LIMITED WARRANTY

The Program is provided "as is" without warranty of any kind, either express or implied. Telestream does not warrant that the functions contained in the Program will meet Customer's requirements or that the operation of the Program will be uninterrupted or error-free.

TELESTREAM AND ITS VENDORS DISCLAIM ANY IMPLIED WARRANTIES OF MERCHANTABILITY OR FITNESS FOR A PARTICULAR PURPOSE. LIMITATION OF LIABILITY, IN NO EVENT SHALL TELESTREAM OR OTHERS FROM WHOM TELESTREAM HAS OBTAINED A LICENSING RIGHT BE LIABLE FOR ANY INDIRECT, SPECIAL, INCIDENTAL, OR CONSEQUENTIAL DAMAGES ARISING OUT OF OR CONNECTED WITH CUSTOMER'S POSSESSION OR USE OF THE PROGRAM, EVEN IF TELESTREAM OR SUCH OTHERS HAS ADVANCE NOTICE OF THE POSSIBILITY OF SUCH DAMAGES.

THIRD-PARTY DISCLAIMER

Except as expressly agreed otherwise, third parties from whom Telestream may have obtained a licensing right do not warrant the program, do not assume any liability with respect to its use, and do not undertake to furnish any support or information relating thereto.

GENERAL

This Agreement contains the entire agreement between the parties with respect to the use, reproduction, and transfer of the Program. Neither this Agreement nor the license granted herein is assignable or transferable by Customer without the prior written consent of Telestream. This Agreement and the license granted herein shall be governed by the laws of the state of California. All questions regarding this Agreement or the license granted herein should be directed to the nearest Telestream Sales Office.

Table of Contents

Important compliance and safety information	vii
Preface	xvii
Product Description.....	xvii
Documentation.....	xviii
Conventions used in this manual.....	xviii
Installation.....	1
Initial product inspection	1
Accessories.....	2
Operating requirements	3
Equipment rack installation.....	4
Rear panel connectors.....	4
SFP module installation	8
Power-on and power-off procedures.....	8
Operation	11
Front panel controls and connectors.....	11
Display elements.....	12
Methods of operation	13

Important compliance and safety information

United States of America Compliance Notices

Class A Interference Statement

This equipment has been tested and found to comply with the limits for a Class A digital device, pursuant to Part 15, Subpart B of the FCC Rules. These limits are designed to provide reasonable protection against harmful interference in a commercial installation. This equipment generates, uses, and can radiate radio frequency energy and, if not installed and used in accordance with the instructions, may cause harmful interference to radio communications. However, there is no guarantee that interference will not occur in a particular installation. Operation of this equipment in a residential area is likely to cause harmful interference in which case the user will be required to correct the interference at his own expense.

FCC Caution

This device complies with Part 15 of the FCC Rules. Operation is subject to the following two conditions:

- (1) This device may not cause harmful interference, and
- (2) This device must accept any interference received, including interference that may cause undesired operation.

Safety

UL 61010-1: 2012 R7.19: Safety Requirements for Electrical Equipment for Measurement, Control, and Laboratory Use - Part 1: General Requirements.

Environmental

Perchlorate Materials: this product contains one or more type CR lithium batteries. According to the state of California, CR lithium batteries are classified as perchlorate materials and require special handling.

See www.dtsc.ca.gov/hazardouswaste/perchlorate for additional information.

Canada Compliance Notices

Department of Communications Radio Interference Regulations

This digital apparatus does not exceed the Class A limits for radio-noise emissions from a digital apparatus as set out in the Radio Interference Regulations of the Canadian Department of Communications. This Class A digital apparatus complies with Canadian ICES-003.

Reglement sur le brouillage radioelectrique du Quadstere des Communications

Cet appareil numerique respecte les limites de bruits radioelectriques visant les appareils numeriques de classe A prescrites dans le Reglement sur le brouillage radioelectrique du Quadstere des Communications du Canada. Cet appareil numerique de la Classe A est conforme a la norme NMB-003 du Canada.

Safety

CAN/CSA-C22.2 NO. 61010-1-12 + G11 + G12 (R2017) + A1: Safety Requirements for Electrical Equipment for Measurement, Control, and Laboratory Use - Part 1: General Requirements.

Sécurité

CAN/CSA-C22.2 NO. 61010-1-12 + G11 + G12 (R2017) + A1: Exigences de sécurité pour l'électricité

European Union and European Free Trade Association (EFTA) Compliance Notices

This equipment may be operated in the countries that comprise the member countries of the European Union and the European Free Trade Association. These countries, listed in the following paragraph, are referred to as The European Community throughout this document:

AUSTRIA, BELGIUM, BULGARIA, CYPRUS, CZECH REPUBLIC, DENMARK, ESTONIA, FINLAND, FRANCE, GERMANY, GREECE, HUNGARY, IRELAND, ITALY, LATVIA, LITHUANIA, LUXEMBOURG, MALTA, NETHERLANDS, POLAND, PORTUGAL, ROMANIA, SLOVAKIA, SLOVENIA, SPAIN, SWEDEN, UNITED KINGDOM, ICELAND, LICHTENSTEIN, NORWAY, SWITZERLAND

Declaration of Conformity

Marking by the "CE" symbol indicates compliance with the Essential Requirements of the EMC Directive of the European Union 2014/30/EU

This equipment meets the following conformance standards:

Safety

EN 61010-1: 2010 + A1: Safety Requirements for Electrical Equipment for Measurement, Control, and Laboratory Use - Part 1: General Requirements
Low Voltage Directive 2014/35/EU

Emissions

EN 55032: 2015 + A11: 2020, CISPR 32: 2015, EN 61000-3-2: 2014, EN 61000-3-3: 2013

Immunity

EN 55103-2: 2009, EN 61000-4-2: 2009, EN 61000-4-3: 2006 + A1: 2008 + A2: 2010,
EN 61000-4-4: 2012, EN 61000-4-5: 2014 + A1: 2017, EN 61000-4-6: 2014, EN 61000-4-8: 2010,
EN 61000-4-11: 2020
Environments: E2

Warnings



Warning! This is a Class A product. In a domestic environment, this product may cause radio interference, in which case, the user may be required to take appropriate measures.



Achtung! Dieses ist ein Gerät der Funkstorgrenzwertklasse A. In Wohnbereichen können bei Betrieb dieses Gerätes Rundfunkstörungen auftreten, in welchen Fällen der Benutzer für entsprechende Gegenmaßnahmen verantwortlich ist.



Attention! Ceci est un produit de Classe A. Dans un environnement domestique, ce produit risque de créer des interférences radioélectriques, il appartient alors à l'utilisateur de prendre les mesures spécifiques appropriées.

Notes:

1. For Compliance with the EMC standards listed here, high quality shielded interface cables should be used.
2. Emissions which exceed the levels required by this standard may occur when this equipment is connected to a test object.

Environmental Compliance

This section provides information about the environmental impact of the product.

Product end-of-life handling

Observe the following guidelines when recycling an instrument or component:

Equipment recycling

Production of this equipment required the extraction and use of natural resources. The equipment may contain substances that could be harmful to the environment or human health if improperly handled at the product's end of life. To avoid release of such substances into the environment and to reduce the use of natural resources, we encourage you to recycle this product in an appropriate system that will ensure that most of the materials are reused or recycled appropriately.



This symbol on the product or its packaging indicates that this product complies with the applicable European Union requirements according to Directives 2012/19/EU and 2006/66/EC on waste electrical and electronic - equipment (WEEE) and batteries.



It also indicates that this product must not be disposed of with your other household waste. Instead, it is your responsibility to dispose of your waste equipment by handing it over to a designated collection point for the recycling of waste electrical and electronic equipment. The separate collection and recycling of your waste equipment at the time of disposal will help conserve natural resources and ensure that it is recycled in a manner that protects human health and the environment. For more information about where you can drop off your waste for recycling, please contact your local authority, or where you purchased your product.

Battery Recycling

This product may contain a rechargeable battery, which must be recycled or disposed of properly. Please properly dispose of or recycle the battery according to local government regulations.

Transporting Batteries or products with Batteries in them

The capacity of the lithium ion secondary battery shipped with this product is under 100 Wh. The lithium content of the installed primary battery is under 1 g. Each battery meets the applicable requirements of UN Manual of Tests and Criteria Part III Section 38.3. Battery quantity is under the limit for shipment according to Section II of the relevant Packing Instructions from the IATA Dangerous Goods Regulations. Consult your air carrier for applicability and determination of any special lithium battery transportation requirements.

Restriction of Hazardous Substances

This product is classified as an industrial monitoring and control instrument, and is not required to comply with the substance restrictions of the RoHS 3 Directives 2011 /65/EU and EU 2015/863 until July 22, 2021. This product does, however, comply with the RoHS 2 Directive 2011/65/EU.

Korea Compliance Statement

사 용 자 안 내 문
이 기기는 업무용 환경에서 사용할 목적으로 적합성평가를 받은 기기로서 가정용 환경에서 사용하는 경우 전파간섭의 우려가 있습니다.

Taiwan Compliance Statement

警告使用者：
這是甲類的資訊產品，在居住的環境中使用時，可能會造成射頻干擾，在這種情況下，使用者會被要求採取某些適當的對策。

This is a Class A product based on the standard of the Bureau of Standards, Metrology and Inspection (BSMI) CNS 13438, Class A. In a domestic environment this product may cause radio interference in which case the user may be required to take adequate measures.

Japan Compliance Statement

この装置は、クラスA情報技術装置です。この装置を家庭環境で使用すると電波妨害を引き起こすことがあります。この場合には使用者が適切な対策を講ずるよう要求されることがあります。 VCCI-A

This is a Class A product based on the standard of the VCCI Council (VCCI 32: 2016). If this equipment is used in a domestic environment, radio interference may occur, in which case, the user may be required to take corrective actions.

Important Safety Information

To safely perform service on this product, see the Service safety summary that follows the General safety summary.

General Safety Summary

Use the product only as specified. Review the following safety precautions to avoid injury and prevent damage to this product or any products connected to it. Carefully read all instructions. Retain these instructions for future reference.

Comply with local and national safety codes.

For correct and safe operation of the product, it is essential that you follow generally accepted safety procedures in addition to the safety precautions specified in this manual.

The product is designed to be used by trained personnel only.

Only qualified personnel who are aware of the hazards involved should remove the cover for repair, maintenance, or adjustment.

Before use, always check the product with a known source to be sure it is operating correctly.

While using this product, you may need to access other parts of a larger system. Read the safety sections of the other component manuals for warnings and cautions related to operating the system.

When incorporating this equipment into a system, the safety of that system is the responsibility of the assembler of the system.

To Avoid Fire or Personal Injury

Use proper power cord: Use only the power cord specified for this product and certified for the country of use. Do not use the provided power cord for other products.

Ground the product: This product is grounded through the grounding conductor of the power cord. To avoid electric shock, the grounding conductor must be connected to earth ground. Before making connections to the input or output terminals of the product, ensure that the product is properly grounded. Do not disable the power cord grounding connection.

Power disconnect: The power cord disconnects the product from the power source. See instructions for the location. Do not position the equipment so that it is difficult to operate the power cord; it must remain accessible to the user at all times to allow for quick disconnection if needed.

Observe all terminal ratings: To avoid fire or shock hazard, observe all rating and markings on the product. Consult the product manual for further ratings information before making connections to the product. Do not apply a potential to any terminal, including the common terminal, that exceeds the maximum rating of that terminal.

Do not operate without covers: Do not operate this product with covers or panels removed, or with the case open. Hazardous voltage exposure is possible.

Avoid exposed circuitry: Do not touch exposed connections and components when power is present.

Do not operate with suspected failures: If you suspect that there is damage to this product, have it inspected by qualified service personnel.

Disable the product if it is damaged. Do not use the product if it is damaged or operates incorrectly. If in doubt about safety of the product, turn it off and disconnect the power cord. Clearly mark the product to prevent its further operation.

Before use, inspect voltage probes, test leads, and accessories for mechanical damage and replace when damaged. Do not use probes or test leads if they are damaged, if there is exposed metal, or if a wear indicator shows.

Examine the exterior of the product before you use it. Look for cracks or missing pieces.

Use only specified replacement parts.

Do not operate in wet/damp conditions: Be aware that condensation may occur if a unit is moved from a cold to a warm environment.

Do not operate in an explosive atmosphere.

Keep product surfaces clean and dry: Remove the input signals before you clean the product.

Provide proper ventilation: Refer to the manual's installation instructions for details on installing the product so it has proper ventilation.

Slots and openings are provided for ventilation and should never be covered or otherwise obstructed. Do not push objects into any of the openings.

Provide a safe working environment: Always place the product in a location convenient for viewing the display and indicators.

Be sure your work area meets applicable ergonomic standards. Consult with an ergonomics professional to avoid stress injuries.

Use only the Telestream rackmount hardware specified for this product.

Service Safety Summary

The Service safety summary section contains additional information required to safely perform service on the product. Only qualified personnel should perform service procedures. Read this Service safety summary and the General safety summary before performing any service procedures.

To avoid electric shock: Do not touch exposed connections.

Do not service alone: Do not perform internal service or adjustments of this product unless another person capable of rendering first aid and resuscitation is present.

Disconnect power: To avoid electric shock, switch off the product power and disconnect the power cord from the mains power before removing any covers or panels, or opening the case for servicing.

Use care when servicing with power on: Dangerous voltages or currents may exist in this product. Disconnect power, remove battery (if applicable), and disconnect test leads before removing protective panels, soldering, or replacing components.

Verify safety after repair: Always recheck ground continuity and mains dielectric strength after performing a repair.

Terms in the Manual

These terms may appear in this manual:



WARNING: Warning statements identify conditions or practices that could result in injury or loss of life.



CAUTION: Caution statements identify conditions or practices that could result in damage to this product or other property.

Terms on the Product

These terms may appear on the product:

DANGER indicates an injury hazard immediately accessible as you read the marking.

WARNING indicates an injury hazard not immediately accessible as you read the marking.

CAUTION indicates a hazard to property including the product.

Symbols on the Product



When this symbol is marked on the product, be sure to consult the manual to find out the nature of the potential hazards and any actions which have to be taken to avoid them. (This symbol may also be used to refer the user to ratings in the manual.)

The following symbol(s) may appear on the product:

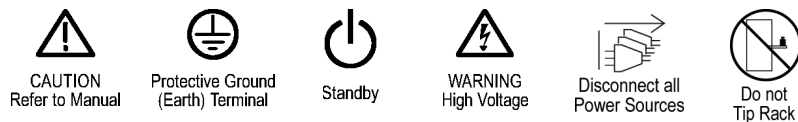

General Safety Product Specific Statements

Use the product only as specified. Review the following safety precautions to avoid injury and prevent damage to this product or any products connected to it. Carefully read all instructions. Retain these instructions for future reference.

Comply with local and national safety codes.

For correct and safe operation of the product, it is essential that you follow generally accepted safety procedures in addition to the safety precautions specified in this manual. The product is designed to be used by trained personnel only.

Only qualified personnel who are aware of the hazards involved should remove the cover for repair, maintenance, or adjustment.

Before use, always check the product with a known source to be sure it is operating correctly.

This product is not intended for detection of hazardous voltages.

Use personal protective equipment to prevent shock and arc blast injury where hazardous live conductors are exposed.

When incorporating this equipment into a system, the safety of that system is the responsibility of the assembler of the system.



WARNING: To prevent injury or death, power off the instrument and disconnect it from line voltage before cleaning.

ADVERTENCIA: Para evitar el riesgo de lesión o muerte, apague el equipo y desconéctelo de la toma de corriente antes de limpiarlo.

WARNUNG: Um Verletzungen oder Tod zu vermeiden, schalten Sie das Gerät aus und trennen Sie es von der Netzspannung, bevor Sie es reinigen.

ATTENTION: Afin de prévenir de tout risque de blessure ou mort, veuillez éteindre et déconnecter l'appareil du secteur avant de le nettoyer.

AVVERTIMENTO: Per prevenire lesioni o morte dell'operatore, spegnere lo strumento e scollegarlo dalla presa di corrente prima di qualsiasi operazione di pulizia.

AVISO: Para evitar risco de lesão ou morte, desligue o instrumento e desconecte-o da corrente antes de limpá-lo.



WARNING: To reduce the risk of fire and shock, ensure that the mains supply voltage fluctuations do not exceed 10% of the operating voltage range.

ADVERTENCIA: Para evitar el riesgo de fuego y descargas, asegúrese de que las fluctuaciones de voltaje de la fuente de alimentación no exceden 10% del rango operativo de voltaje.

WARNUNG: Um die Brand- und Stromschlaggefahr zu verringern, stellen Sie sicher, dass die Schwankungen der Netzspannung 10% des Betriebsspannungsbereichs nicht überschreiten.

ATTENTION: Pour éviter tout risque de feu ou choc électrique, assurez vous que les variations de tension ne soient pas supérieure à 10% de la valeur nominale.

AVVERTIMENTO: Per ridurre il pericolo di incendi e folgorazioni, assicurarsi che le fluttuazioni della tensione di rete siano contenute entro il 10% del valore nominale.

AVISO: Para reduzir o risco de incêndio e choque, certifique-se de que as flutuações da voltagem da rede elétrica não excedam 10% da faixa de tensão de operação.



WARNING: To prevent injury or damage to the instrument, do not carry the PRISM monitor by the small handles on the front sides of the instrument. These handles are for pulling the instrument out of a rackmount installation and are not intended to be used for carrying the instrument.

ADVERTENCIA: Para evitar lesión o daños al equipo, no sujete el monitor PRISM por las asas del frente del equipo. Estas asas son para sacar el equipo de una instalación de rack y no están diseñadas para sujetarlo.

WARNUNG: Um Verletzungen oder Schäden am Gerät zu vermeiden, sollten Sie den PRISM Monitor nicht an den Griffen an der Vorderseite des Geräts tragen. Diese Griffe dienen zum Herausziehen des Geräts aus einer

Rack-Installation und sind nicht zum Tragen des Geräts gedacht.

ATTENTION: Afin d'éviter tout dommage ou casse de matériel ne pas porter le Prism avec les anses de devant. Celle-ci servent à retirer le matériel du rack et ne servent pas à le porter.

AVVERTIMENTO: Per evitare lesioni o danni allo strumento, non utilizzate le maniglie frontali per trasportare l'apparato. Queste maniglie servono esclusivamente per estrarre lo strumento dal rack e non sono idonee al trasporto dello strumento.

AVISO: Para evitar ferimentos ou danos ao instrumento, não transporte o monitor PRISM pela pega na parte frontal do instrumento. Estas pegas são para puxar o instrumento para fora de uma instalação em rack e não se destinam ao transporte do instrumento.



WARNING: In the instrument, only the line conductor is fused for over-current protection. The fuse is internal and not user replaceable. Do not attempt to replace the fuse. If you suspect the fuse is not conducting current, return the unit to an authorized service center for repair.

ADVERTENCIA: En el equipo, solo el conductor de línea lleva fusible como protección de sobrecarga. El fusible es interno y no reemplazable por el usuario. No intente cambiar el fusible. Si sospecha que el fusible no está conduciendo corriente, devuelva el equipo a un centro de servicio autorizado para su reparación.

WARNUNG: Im Gerät ist nur der Netzleiter zum Schutz gegen Überstrom abgesichert. Die Sicherung ist fest verbaut und kann nicht vom Benutzer ausgetauscht werden. Versuchen Sie nicht, die Sicherung zu ersetzen. Wenn Sie den Verdacht haben, dass die Sicherung defekt ist, bringen Sie das Gerät zur Reparatur in ein autorisiertes Servicezentrum.

ATTENTION: Dans l'instrument seul le secteur a une protection contre les court circuit (ou sur tension). Le fusible est à l'intérieur du matériel et ne peut pas être remplacé par l'utilisateur. N'essayez pas de le remplacer. Si vous suspectez le fusible, veuillez renvoyer le matériel dans un centre de réparation agréé.

AVVERTIMENTO: Lo strumento è protetto con un fusibile sul conduttore della fase. Il fusibile è interno e non può essere sostituito dall'utente. Non tentare di sostituire il fusibile. Se pensate che il fusibile si sia bruciato, inviate l'unità a un centro di assistenza autorizzato per la riparazione.

AVISO: No instrumento, apenas o condutor da linha possui fusível para proteção contra sobrecorrente. O fusível é interno e não pode ser substituído pelo utilizador. Não tente substituir o fusível. Se suspeitar que o fusível não está conduzindo corrente, devolva a unidade a um centro de serviço autorizado para reparação.



CAUTION: To reduce risk of fire and shock, use the certified power cord provided with the product.

PRECAUCIÓN: Para evitar riesgo de incendio o descarga, use el cable de alimentación certificado que se suministró con el equipo.

VORSICHT: Um die Gefahr von Feuer und Stromschlag zu verringern, verwenden Sie das mit dem Gerät gelieferte zertifizierte Netzkabel.

AVERTIR: Pour réduire le risque d'incendie et de choc électrique, veuillez utiliser un cordon secteur certifié.

ATTENZIONE: Per ridurre il rischio di incendi e folgorazioni, utilizzare il cavo di alimentazione certificato fornito con il prodotto.

CUIDADO: Para reduzir o risco de incêndio e choque, use o cabo de alimentação certificado fornecido com o produto.



CAUTION: Damage to the instrument can occur if this instrument is powered on at temperatures outside the specified temperature range.

PRECAUCIÓN: Hay peligro de daños al equipo si se enciende a temperaturas que estén fuera del rango especificado.

VORSICHT: Das Gerät kann beschädigt werden, wenn es bei Temperaturen außerhalb des angegebenen Temperaturbereichs eingeschaltet wird.

AVERTIR: Des dommages peuvent être produits par la mise sous tension dans des plages de température en dehors des valeurs spécifiées.

ATTENZIONE: Non accendere lo strumento se la temperatura ambiente è al di fuori dell'intervallo specificato in quanto si possono provocare danni.

CUIDADO: Podem ocorrer danos ao instrumento se este for ligado em temperaturas fora da faixa de temperatura especificada.



CAUTION: To prevent static damage to the SFP module, if you remove the SFP module from the instrument, always transport the SFP module in an anti-static bag or container.

PRECAUCIÓN: Para evitar daños producidos por electricidad estática, cuando quite un módulo SFP del equipo se recomienda guardarlo y transportarlo en una bolsa o contenedor antiestático.

VORSICHT: Um statische Schäden am SFP-Modul zu vermeiden, sollten Sie das SFP-Modul immer in einem antistatischen Beutel oder Behälter aufbewahren und transportieren, wenn Sie es aus dem Gerät entfernen.

AVERTIR: Pour éviter des problèmes d'électricité statique, si vous retirez le SFP de l'instrument, veuillez le stocker et le transporter dans un sac ant-statique.

ATTENZIONE: Se si rimuovono gli SFP dallo strumento, conservarli e trasportarli in una busta anti statica o altro contenitore idoneo in modo da evitare danni dovuti alla elettricità statica (ESD).

CUIDADO: Para evitar danos estáticos ao módulo SFP, se você remover o módulo SFP do instrumento, armazene e transporte sempre o módulo SFP em um saco ou recipiente antiestático.



CAUTION: To minimize the risk of damage to the instrument, we strongly recommend the power cord be connected to the instrument before the power cord is connected to the AC power source.

PRECAUCIÓN: Para minimizar el riesgo de daños al equipo, se recomienda que el cable de alimentación se conecte al equipo antes de que se conecte a la fuente de alimentación de corriente alterna.

VORSICHT: Um das Risiko einer Beschädigung des Geräts zu minimieren, empfehlen wir dringend, das Netzkabel an das Gerät anzuschließen, bevor das Netzkabel an die Stromquelle angeschlossen wird.

AVERTIR: Pour minimiser les risques de dégâts, nous recommandons vivement que le cordon secteur soit d'abord connecté à l'instrument avant la source d'alimentation.

ATTENZIONE: Per ridurre al minimo il rischio di danni allo strumento, si consiglia vivamente di collegare il cavo di alimentazione allo strumento prima che il cavo di alimentazione sia collegato alla fonte di alimentazione CA.

CUIDADO: Para minimizar o risco de danos ao instrumento, recomendamos fortemente que o cabo de alimentação seja conectado ao instrumento antes de conectá-lo à fonte de alimentação AC.



CAUTION: To prevent data loss, we strongly recommend you first shut down the instrument before disconnecting the power cord. Press the power button or select Settings, Utilities, Power, and then Power Down Now.

PRECAUCIÓN: Para evitar la pérdida de datos, se recomienda apagar el equipo antes de desconectar el cable de alimentación. Pulse el botón de encendido o seleccione en el menú *Settings, Utilities, Power*, y *Power Down Now*.

VORSICHT: Um Datenverluste zu vermeiden, empfehlen wir dringend, das Gerät erst auszuschalten, bevor Sie das Netzkabel abziehen. Drücken Sie die Netztaaste oder wählen Sie *Settings, Utilities, Power* und dann *Power Down Now*.

AVERTIR: Pour éviter des pertes de données, veuillez éteindre le matériel avant de déconnecter le secteur. Appuyer sur le bouton Power ou sélectionner *Settings, Utilities, Power* et *Power Down Now* dans le menu.

ATTENZIONE: Per prevenire la perdita di dati, si consiglia vivamente di spegnere lo strumento prima di scollegare il cavo di alimentazione. Premi il pulsante di accensione o seleziona *Settings, Utilities, Power*, quindi *Power Down Now*.

CUIDADO: Para evitar perda de dados, é altamente recomendável desligar o instrumento antes de desconectar o cabo de alimentação. Pressione o botão liga / desliga ou selecione *Settings, Utilities, Power* e *Power Down Now*.



CAUTION: Avoid the use of chemical cleaning agents that might damage the plastics used in the instrument. Use only deionized water when cleaning the front-panel buttons. For the rest of the instrument, use a 75% isopropyl alcohol solution as a cleaner and rinse with deionized water. Before using any other type of cleaner, consult your Telestream service center or representative.

PRECAUCIÓN: Evite el uso de agentes químicos de limpieza que puedan dañar los plásticos del equipo. Use sólo agua desionizada para limpiar los botones del panel frontal. Para el resto del equipo, use una solución de alcohol isopropílico 75% como limpiador, y aclare con agua desionizada. Antes de usar cualquier otro tipo de limpiador, consulte con su centro de reparación de Telestream o su agente.

VORSICHT: Vermeiden Sie die Verwendung von chemischen Reinigungsmitteln, die die im Gerät verwendeten Kunststoffe beschädigen könnten. Verwenden Sie zum Reinigen der Tasten auf der Vorderseite des Geräts nur entionisiertes Wasser. Verwenden Sie für den Rest des Geräts eine 75%ige Isopropylalkohol-Lösung als Reinigungsmittel und spülen Sie mit entionisiertem Wasser nach. Wenden Sie sich an Ihren Telestream-Kundendienst, bevor Sie ein anderes Reinigungsmittel verwenden.

AVERTIR: Évitez d'utiliser des produits chimiques pour le nettoyage, ils pourraient endommager les plastiques. Utilisez uniquement de l'eau déminéralisée pour nettoyer les boutons de face avant. Pour le reste de l'instrument de l'alcool isopropil à 75% convient. Rincer à l'eau déminéralisée ensuite. Avant d'utiliser tout autre produit veuillez contact votre représentant Telestream.

ATTENZIONE: Evitare l'uso di detergenti chimici che potrebbero danneggiare la plastica utilizzata nello strumento. Utilizzare solo acqua deionizzata per pulire i pulsanti del pannello anteriore. Per il resto dello strumento, utilizzare una soluzione di alcol isopropilico al 75% come detergente e risciacquare con acqua deionizzata. Prima di utilizzare qualsiasi altro tipo di detergente, consultare il centro di assistenza o il rappresentante Telestream.

CUIDADO: Evite o uso de agentes químicos de limpeza que possam danificar os plásticos usados no instrumento. Use apenas água desionizada ao limpar os botões do painel frontal. Para o restante do instrumento, use uma solução de álcool isopropílico 75% como limpador e enxágue com água desionizada. Antes de usar qualquer outro tipo de produto de limpeza, consulte o seu centro de serviço ou representante Telestream.

Preface

This manual describes how to install the PRISM SDI / IP Waveform Monitor and provides basic safety and operating information. Detailed operating information is available in the user manual. A complete list of PRISM documentation is provided in this manual. (See the section Documentation.)

Product Description

The PRISM SDI / IP Waveform Monitor provides flexible options and field-installable upgrades to monitor a diverse variety of SDI and IP statistics as well as video and audio content. The comprehensive feature set, along with an intuitive and simplified graphical presentation of IP statistics, including video quality and diagnostic information, enables engineers to ensure the delivery of superior QoS levels in an increasingly complex broadcast environment involving compressed / uncompressed video transmission through SDI/IP signal paths. PRISM is an ideal solution for monitoring SDI/IP hybrid environments including master control rooms, production studios, OB vans, and signal contribution/distribution centers.

Features and Benefits

- A comprehensive analysis and monitoring tool for a hybrid IP / SDI broadcast systems that provides system evaluation for long term system quality monitoring and reporting
- All-in-one instrument within a 1RU full rack-width platform
- Extensive IP monitoring solution for SMPTE 2022-6, 2110, PTP, and RTP streams
- Graphical displays that show the traffic present in the 10/25G Ethernet link, allowing engineers to understand what is on their network and to easily select the stream of interest
- Select a stream to view and monitor the content using the Picture, Waveform, and Audio applications, and listen to audio with headphones for conformance monitoring
- Detect IP packet errors, monitor the packet inter arrival time (PIT) and time stamped delay factor (TS-DF) to allow engineers to observe issues that may cause intermittent loss of Video, Audio or Data
- Monitor PTP trend graphs to ensure proper IP system setup for robust sync system
- Telestream patented timing display showing the relative timing of the input signal and PTP reference that makes facility timing easy
- 1 PPS output when the instrument is locked to a PTP reference
- Seamless switching to ensure proper SMPTE 2022 and 2110 redundant system operation API to control PRISM from system management software
- Multipoint or remote site monitoring allowing one engineer to quickly respond to issues from multiple points in the system Optional 10/25GbE line rate packet capture for offline analysis
- Optional SDI and ST2110 IP signal generators for testing new or changing facility configurations NMOS IS-04 / IS-05 support for network discovery and connection management

Documentation

Table 1: Product documentation

Document	Manual type	Part number	Description	Availability	
				Print	Web
User Manual	User	D00010019x	Provides detailed operating information.		√
Release Notes	Release Notes	D00010030x	Describes the new features, improvements, and limitations of the instrument firmware.		√
Installation and Safety Instructions	User	071-3738-00x	Describes how to install a PRISM MPX2-25 instrument and provides basic safety and operating information (included with instrument).	√	√
MPX Rackmount Slides and Rails Installation Instructions	Field Install Instructions	071-3706-00x	and provides basic safety and operating information (included with instrument).	√	√
PRISM MPX2-DUALDSP Installation and Safety Instructions	Field Install Instructions	071-3729-00x	Provides installation and safety information for the PRISM MPX2-DUALDSP Dual Display module.	√	√

Conventions used in this manual

These icons may be used throughout this manual.

Sequence Step



Front panel power



Connect power

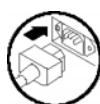

Network

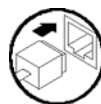

SVGA

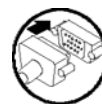

USB

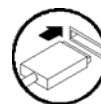

Installation

Initial product inspection

Inspect the product when you receive your instrument:

1. Inspect the shipping carton for external damage, which may indicate damage to the instrument.



WARNING: To prevent injury or damage to the instrument, do not carry the PRISM monitor by the small handles on the front sides of the instrument. These handles are for pulling the instrument out of a rackmount installation and are not intended to be used for carrying the instrument.

2. Remove the PRISM monitor from the shipping carton, and then check that the instrument has not been damaged in transit. Prior to shipment the instrument is thoroughly inspected for mechanical defects. The exterior should not have any scratches or impact marks.

Note: Save the shipping carton and packaging materials for instrument repackaging in case shipment becomes necessary.

3. Verify that the shipping carton contains the instrument, the standard accessories, and any optional accessories that you ordered. See the section *Accessories*.
4. Verify that all of the product options you ordered are installed:
 - a. After you install and power-on the instrument, select the **Settings** icon.
 - b. Select the **Utilities** bar.
 - c. Select the **Options** bar.

The display lists all the installed product options (for example, MP2-IP-MEAS) and the license expiration dates. If an expiration reads “None” then the license will not expire.

Exterior cleaning

The instrument exterior was inspected for debris when it was shipped. If necessary, you can clean the exterior of the instrument.



WARNING: To prevent injury or death, power off the instrument and disconnect it from line voltage before cleaning.

Clean the exterior surfaces of the chassis with a dry lint-free cloth or a soft-bristle brush. If any dirt remains, use a cloth or swab dipped in a 75% isopropyl alcohol solution. Use a swab to clean narrow spaces around controls and connectors. Do not use abrasive compounds on any part of the instrument that may be damaged by it.



CAUTION: Avoid the use of chemical cleaning agents that might damage the plastics used in the instrument. Use only deionized water when cleaning the front-panel buttons. For the rest of the instrument, use a 75% isopropyl alcohol solution as a cleaner and rinse with deionized water. Before using any other type of cleaner, consult your Telestream service center or representative.

Accessories

Table 2: Standard and optional accessories

Accessory	Std.	Opt.	Part number
Installation and Safety Instructions	√		071- 3738-00x
Power cord See the section, International power cords.	√		NA
SFP and transceiver modules:			
SD/HD/3G Optical (1310 nm) SDI SFP transmitter module (to be installed into SDI SFP cage for optical SDI loop through output)		√	MP-SFP Opt. 3GTO
SD/HD/3G DIN SDI SFP transmitter module (to be installed into SDI SFP cage for SDI loop through output with DIN coaxial connector)		√	MP-SFP Opt. 3GTD
SD/HD/3G HDBNC SDI SFP transmitter module (to be installed into SDI SFP cage for SDI loop through output with HDBNC coaxial connector)		√	MP-SFP Opt. 3GTH
10G Ethernet short range (850 nm) transceiver module		√	MP-SFP Opt. 10GESR
10G Ethernet long range (1310 nm) transceiver module		√	MP-SFP Opt. 10GELR
25G Ethernet short range (850 nm) transceiver module		√	MP-SFP Opt. 25GESR
25G Ethernet long range (1310 nm) transceiver module		√	MP-SFP Opt. 25GELR
Rackmount Slides and Rails Kit		√	MPX2-10 RACK
Dual external 9" touch screen rackmount displays for use with customer-supplied MPX2 unit		√	MPX2-DUALDSP
Cable kits:			
HD-BNC to BNC adapter cables (package of 3)		√	MP-CBL Opt. HDBNC-BNC
Cable kit for MPX2-DUALDSP dual external touch screen.		√	MP-CBL Opt. DUALDSP

International power cords

Your instrument was shipped with one of these power cord options. Power cords for use in North America are UL listed and CSA certified. Cords for use outside North America are approved by at least one authority acceptable in the country to which the product is shipped.

Opt. A0 – North America power cord

Opt. A1 – Universal EUR power cord

Opt. A2 – United Kingdom power cord

Opt. A3 – Australia power cord

Opt. A4 – 240 V, North America power cord

Opt. A5 – Switzerland power cord

Opt. A6 –Japan power cord

Opt. A10 – China power cord

Opt. A11 – India power cord

Opt. A12 – Brazil power cord

Opt. A99 – No power cord



CAUTION: To reduce risk of fire and shock, use the certified power cord provided with the

product.

Operating requirements

This section provides the environmental and power operating requirements for the instrument.

Environmental operating requirements

Check that the location of your installation has the proper operating environment as listed in Table 3.



CAUTION: Damage to the instrument can occur if this instrument is powered on at temperatures outside the specified temperature range.

Table 3: Environmental requirements

Parameter		Description
Temperature	Operating	0 °C to +40 °C
	Non Operating	-20 °C to +60 °C
Humidity	Operating	20% to 80% relative humidity (% RH) at up to +40 °C, non-condensing
	Non Operating	5% to 90% relative humidity (% RH) at up to 40 °C and derated linearly to 45% RH at 60 °C, non-condensing
Altitude	Operating	To 3,000 m (10,000 feet) Maximum operating temperature decreases 1 °C each 300 m above 1.5 km
	Non Operating	To 12,000 m (40,000 feet)
Pollution Degree		Pollution Degree 2 (as defined in IEC 61010-1): Rated for indoor, dry location use only.
Cooling		Internal fans provide forced air circulation. Do not block ventilation openings.
	Bare Instrument	To ensure proper airflow, there must be at least 2 inches of clearance on both sides of the instrument, at least 2 inches of clearance from the rear of the instrument, and at least a 1/2 inch of clearance from the top of the instrument.
	Rackmount Kit	Use only the Rackmount Slides and Rails Kit, MPX2-10 RACK, to install this instrument in an equipment rack. To ensure proper airflow when installing the instrument in a closed rack with solid walls, there must be at least 2 inches of clearance from both sides of the instrument chassis to the rack side walls, at least 3 inches of clearance from the rear of the instrument to the rack's back wall, and at least a 1/2 inch of clearance from the top of the instrument to another installed instrument. The rack intake air to the side vents must not exceed 40 °C.

Electrical power requirements

The instrument operates from an AC power input. Check that your location provides the proper electrical power requirements as listed in Table 4 and Table 5.

AC line power: Use the proper power cord with the instrument. See the section [International power cords](#). Table 4 lists the power requirements for the instrument.

Table 4: AC line power requirements

Parameter	Description
Line voltage range	100 - 240 VAC
	 WARNING: To reduce the risk of fire and shock, ensure that the mains supply voltage fluctuations do not exceed 10% of the operating voltage range.
Line frequency	50/60 Hz
Maximum power	150 W ¹

¹ Typical power is 100 W.



WARNING: In the instrument, only the line conductor is fused for over-current protection. The fuse is internal and not user replaceable. Do not attempt to replace the fuse. If you suspect the fuse is not conducting current, return the unit to an authorized service center for repair.

Physical characteristics

Table 5: Physical characteristics of a bare instrument

Parameter	Description
Dimensions	
Height	4.45 cm (1.75 in.)
Width	48.26 cm (19.00 in.), includes bezel
Depth	45.72 cm (18.00 in.), includes bezel and connectors
Weight	
Net	3.9 kg (8.7 lbs.)
Shipping	Typically 10.21 kg (22.5 lb.), includes rackmount kit

Equipment rack installation

There is an optional Rackmount Slides and Rails Kit available for the PRISM MPX2-10 monitor (MPX2-10 RACK). The rackmount kit includes the *Rackmount Slides and Rails Kit Installation Instructions* document.

Rear panel connectors

Figure 1 shows the external connections to the rear panel of the instrument. A description of each connector is provided in Table 6. See *Front panel controls and connectors* for information about the front panel connectors.

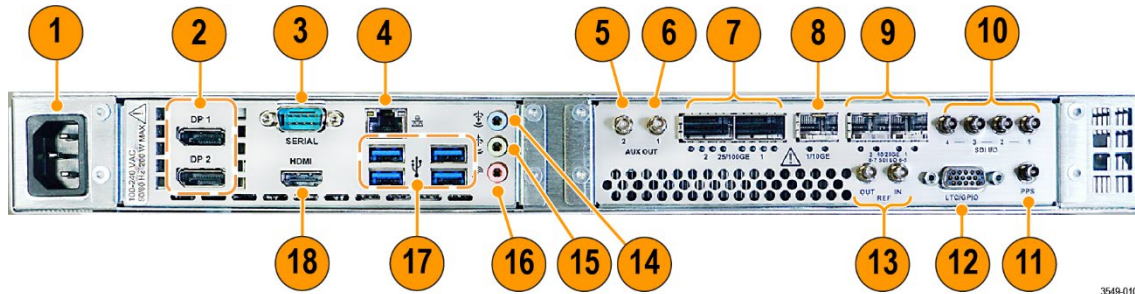
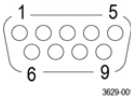



Figure 1: PRISM MPX2-10 rear panel

Table 6: Descriptions of PRISM MPX2-25 rear panel connectors

Item number (See Figure 1.)	Connector label, symbol, or end	Description
1		Connector is for an AC power source.
2	DP	Two DisplayPort outputs are for external monitors. The output video format is 1920×1080. ^{1,2}
3	 SERIAL	Serial interface, 9-pin connector, is not used.
4		Ethernet port is a standard RJ-45 connector for 10/100/1000Base-T Ethernet cable.
5	AUX OUT 2	SDI output of the selected SDI, ST2022, or ST2110 input: <ul style="list-style-type: none"> ▪ Quadlink inputs (4k/8k) the Aux out is link 1 ▪ ST2110-20/30 inputs are supported.
6	AUX OUT 1	SDI output of the selected SDI, ST2022, or ST2110 input: <ul style="list-style-type: none"> ▪ Quadlink inputs (4k/8k) the Aux out is link 1 ▪ ST2110-20/30 inputs are supported.
7	25/100GE	Two QSFP28 ports are for future functionality.
8	1/10GE	SFP IP port is for future functionality.
9	10/25GE SDI I/O	Two SFP module slots can be configured for SDI or IP applications. <ul style="list-style-type: none"> • 10/25GE Two optional SFP ports are for 10/25GbE Ethernet applications. See MP-SFP products for available modules. • SDI I/O Two optional SFP ports can provide up to four SDI signal loop-through outputs, up to 12G for future functionality.
10	SDI I/O	Four HD-BNC inputs can operate in 4 modes: <ul style="list-style-type: none"> • SDI inputs 1-4 support SD/HD/3G/6G/12G signals. • Single SDI link (Option MP2-FMT-4K is required for 6G/12G support), when used as a single link, only one of the SDI 1-4 inputs is active at a time. • Quad 4K links, when used in conjunction with the SDI 1-4 inputs (Option MP2-FMT-4K only). When used as Quad 4K links, all four SDI inputs are





Item number (See Figure 1.)	Connector label, symbol, or end	Description
		<p>active.</p> <ul style="list-style-type: none"> Eye diagram is up to 12G on SDI input 1 only for physical layer measurements, including automated measurement of 12G-SDI eye pattern parameters (requires Options MP2-FMT-4K and PHY).
11	PPS	PPS connector outputs a 1 PPS (pulse per second) signal when the instrument is locked to a PTP reference. 3.3v drive. TTL compatible.
12	LTC/GPIO	LTC/GPIO is a 15-pin, mini D-sub connector, for details see MPX-2-25 remote connector pin assignments and preset functions.
		
13	REF IN – OUT	REF IN is used for analog reference signals black burst and tri-level sync for locking. REF OUT is a pass through of the REF IN.
14		Audio input port is for future use.
15		Audio output (1/8-inch—3.5mm—line out) port is for headphones to listen to the selected audio channel pair. ³
16		Microphone input port is for future use.
17		Four USB 3.0 ports are for connecting a mouse and keyboard, importing or exporting instrument presets, upgrading the instrument firmware, or saving screen and stream captures.
18	HDMI	HDMI port output is for an external monitor. The output video format is 1920×1080. ^{1,2}

Table 7: MPX-2-25 remote connector pin assignments and preset functions

Characteristic	Pin Function
Connector Pin Assignments 	1 GND (In)
	2 Do not connect
	3 Do not connect
	4 Do not connect
	5 Do not connect
	6 GND (In)
	7 Do not connect
	8 Do not connect
	9 Do not connect
	10 Preset 1 (In) ¹
	11 Preset 2 (In) ¹
	12 Preset 3 (In) ¹
	13 Preset 4 (In) ¹
	14 Preset 5 (In) ¹
	15 Preset 6 (In) ¹

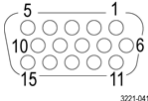
¹Active low inputs, internally pulled up to 5V. A 5V tolerant open drain or open collector driver is recommended.

Note: The presets can be recalled through GPIO. See the PRISM MPI2-25 and MPX2-25 User Manual for details.

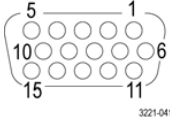
SFP module installation

There are several types of optional SFP modules available. [See Table 2 Standard and optional accessories.](#)

To install the SFP module, first remove the plug from the SFP connector. Insert the SFP module into the SFP connector as shown in Figure 2 (optical SFP module shown). The module will latch into place when fully inserted.

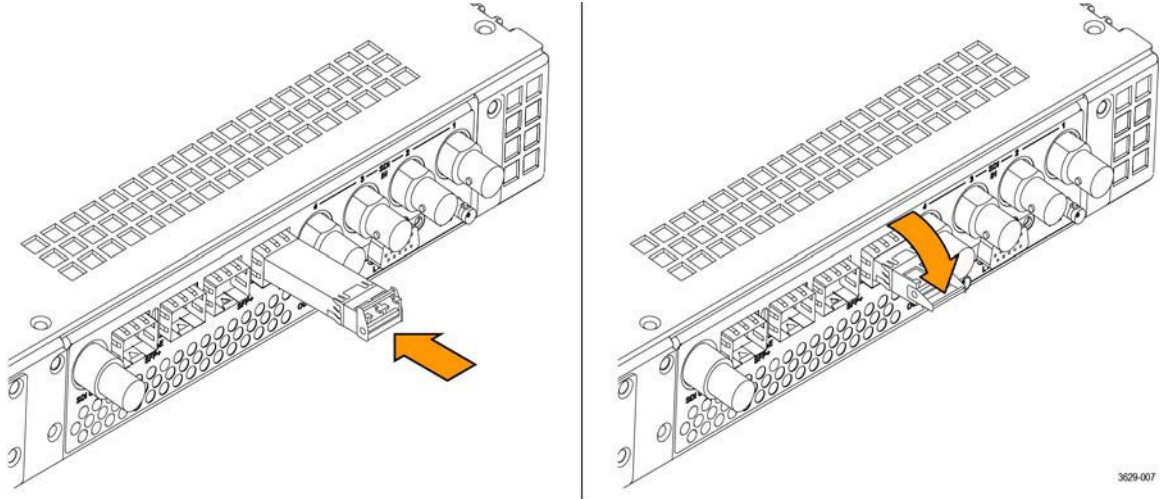

Figure 2: Installing and removing an optical SFP module

To remove the SFP module, pull down on the latch and then pull the module out of the SFP connector as shown above (optical SFP module shown).

Note: An optical SFP module is shown above. Other types of SFP modules may have different latching mechanisms.

SFP module transportation



CAUTION: To prevent static damage to the SFP module, if you remove the SFP module from the instrument, always transport the SFP module in an anti-static bag or container.

Note: QSFP modules are not yet supported.

Power-on and power-off procedures

This section describes how to apply power to the instrument and how to power-on and power-off the instrument.

Power cord installation

This instrument is powered by an AC power source. Connect the power cord to the power connector on the rear panel of the instrument as shown. The power connector is keyed to be directional, with the flat portion of the power cord housing facing the left of the instrument (as viewed from the rear).

When fully inserted, the power cord housing latches onto the instrument power connector.



CAUTION: To minimize the risk of damage to the instrument, we strongly recommend the power cord be connected to the instrument before the power cord is connected to the AC power source.

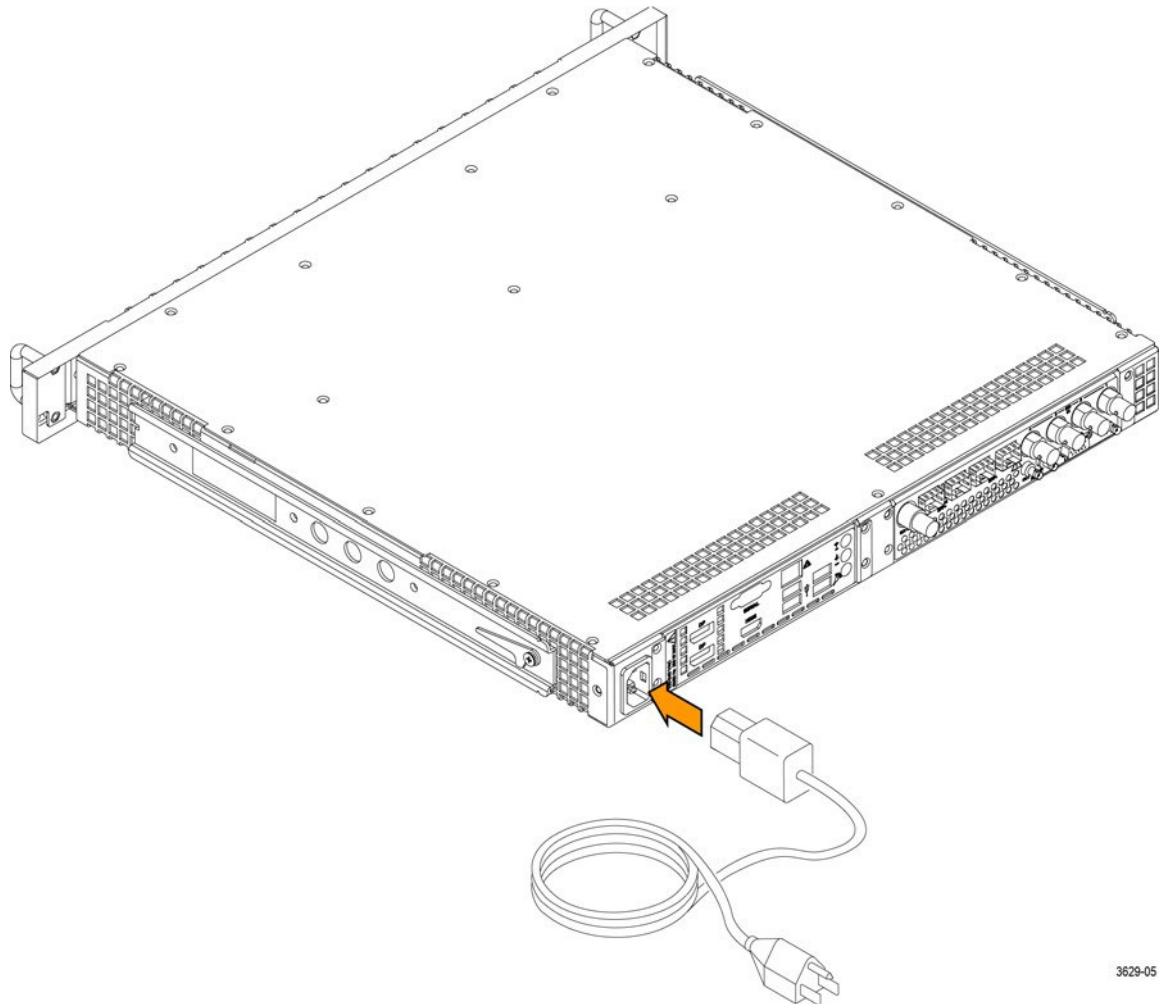

3629-05

Figure 3: Connecting the power cord to the instrument

Power-on procedure

1. Apply power to the instrument. (See *Power cord installation*.)

Note: If the PRISM monitor was previously powered off by a power interruption or by removing the power cord from the rear of the instrument, the instrument will power on when power is reapplied.

2. Press the power button on the instrument front panel to turn the instrument on. (See Figure 4.)

Note: The power button lights during the power-on sequence and then turns off during normal

instrument operation.



Figure 4: Front of the MPX with the power button marked

Power-off procedure

1. Press the power button to turn the instrument off.



CAUTION: To prevent data loss, we strongly recommend you first shut down the instrument before disconnecting the power cord. Press the power button or select Settings, Utilities, Power, and then Power Down Now.

2. To completely remove power from the instrument, disconnect the power cord from the instrument. The power cord has a locking mechanism to keep it attached to the instrument. Push the button on the cord housing to release the locking mechanism.

Operation

Front panel controls and connectors



Figure 5: MPX2-25 front panel controls

Table 8: Descriptions of PRISM MPX2-25 rear panel connectors

Item number	Description
1	Power / Standby button: Press to turn the instrument on or off. To completely remove power from the instrument, remove the power cord.
	 CAUTION: To prevent data loss, we strongly recommend you first shut down the instrument before disconnecting the power cord. Press the power button or select Settings, Utilities, Power, and then Power Down Now.
2	PRESET button: Press once to prepare the instrument for a preset selection from preset Group A using the SELECTIONS buttons (1-6). Press the button repeatedly to select preset Group B-F. ¹
3	BALANCE control: Turn the BALANCE control to adjust the balance on the selected audio output device. Push the BALANCE control to recenter the balance. ¹
4	SELECTIONS buttons: Press PRESET or INPUT, press one of the SELECTIONS buttons (1-6) to recall an instrument preset or to select an input to monitor.
5	VOLUME control: Turn the VOLUME control to adjust the volume on the selected audio output device. Push the VOLUME control to mute or unmute the audio. ¹
6	Audio output: (1/4-inch—6.35mm—line out) port is for using headphones to listen to the selected audio channel pair.
7	USB ports: Two USB 3.0 ports for connecting a mouse and keyboard, importing or exporting instrument presets, upgrading the instrument firmware, or saving screen and stream captures.
8	INPUT button: Press to prepare the instrument for an input selection using the SELECTIONS buttons (1-6). ¹
9	Speakers: Integrated 2.1 speakers for listening to the selected audio channel pair. Requires Option SPKR.

¹ When you use the PRESET and INPUT buttons, the associated menus appear on the display. The menus close after a short time-out period. Similarly, when you use the VOLUME or BALANCE control, the volume or balance slider and mute controls appear on the display and close after a short time-out period.

Display elements

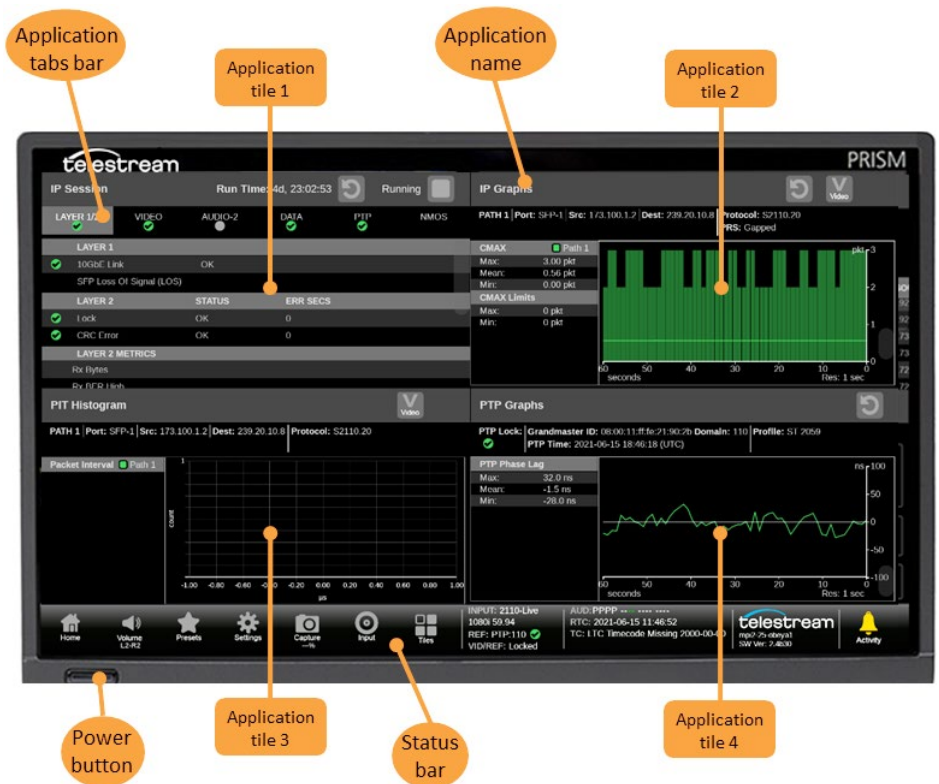

Figure 6: Elements of the front panel

Table 9: Descriptions of PRISM MPX2-25 front panel elements

Item name	Description
Applications tabs	Some applications have selectable tabs (highlighted readouts) you can use to display additional information.
Application tiles 1-4	Location of the application tile ¹
Application name	Lists the name of the displayed application.
Power button	Press the button to turn the instrument on or off. To completely remove power from the instrument, remove the power cord. CAUTION: To prevent data loss, we strongly recommend you first shut down the instrument before disconnecting the power cord. Press the power button or select Settings, Utilities, Power, and then Power Down Now.
Status bar	Status bar: The left side of the Status bar has icons with links to various instrument settings including Volume (Volume icon), Presets (Presets icon), Settings (Settings icon), Input type (Input icon), and the Application menu (Tiles icon). Select the Home icon (Home icon)



) to exit any displayed menus.

The right side of the Status bar lists instrument status such as the selected input, type of input signal, selected signal reference, video/reference signal status, audio channel status, the real-time clock or PTP clock (to switch between the clocks, see Set Time and Date), and a link to the Activity menu



Note: When an instrument setting is selected, the associated menu replaces the Status bar.

¹ The application panels can be shown in four-tile mode or in full screen mode.

Methods of operation

This section describes the three primary methods of operating the instrument:

- Keyboard and mouse with external display
- Remote control through VNC
- External touchscreen display

Keyboard and mouse with external display operation

You can use a USB keyboard and mouse to operate the instrument when an external display is connected to the instrument. The mouse needs to have a scrolling wheel to access all of the menu selections. Click on applications to perform actions like you would on the touch panel.

Connect the keyboard, mouse, and external display:

- Connect the keyboard and mouse to any of the available front or rear-panel USB ports
- Connect the external monitor to any of the available display outputs, including VGA, DVI, or DisplayPort

Front panel operation

You can use the instrument front panel to perform the functions:

- Recall instrument presets
- Select an input to monitor
- Control or mute the volume on the headphone outputs
- Connect a mouse and keyboard
- Connect a USB drive to import or export instrument presets, upgrade the instrument firmware, or save screen and stream captures

Recall instrument presets

1. Press **PRESET** once to prepare the instrument for a preset selection from preset Group A using the SELECTIONS buttons (1-6).
2. Press **PRESET** repeatedly to select preset Group B-F. The selected preset group will be displayed.
3. After you select the preset group, press the SELECTIONS numbered button corresponding to the preset in the group you want to recall (1-6).

Note: When you use the PRESET and INPUT buttons, the associated menus appear on the display. The menus close after a short time-out period. Similarly, when you use the VOLUME control, the volume slider and mute controls appear on the display and close after a short time-out period.

Select an input to monitor

1. Press **INPUT** to prepare the instrument for an input selection.
2. Press the SELECTIONS numbered button corresponding to the input you want to monitor.

External touchscreen operation

You can use an external touchscreen display to control the instrument. Two connections are required:

- Connect the Display Port output from the PRISM monitor to the input on the external device.
- Connect the output of the external device to one of the USB ports on the PRISM monitor.

Note: A monitor with a 1920×1080 capable display works best with the instrument.

Figure 7 shows the application menu, which has all the available applications, open in front of 4 tiled applications. The application menu is different depending on the options purchased.

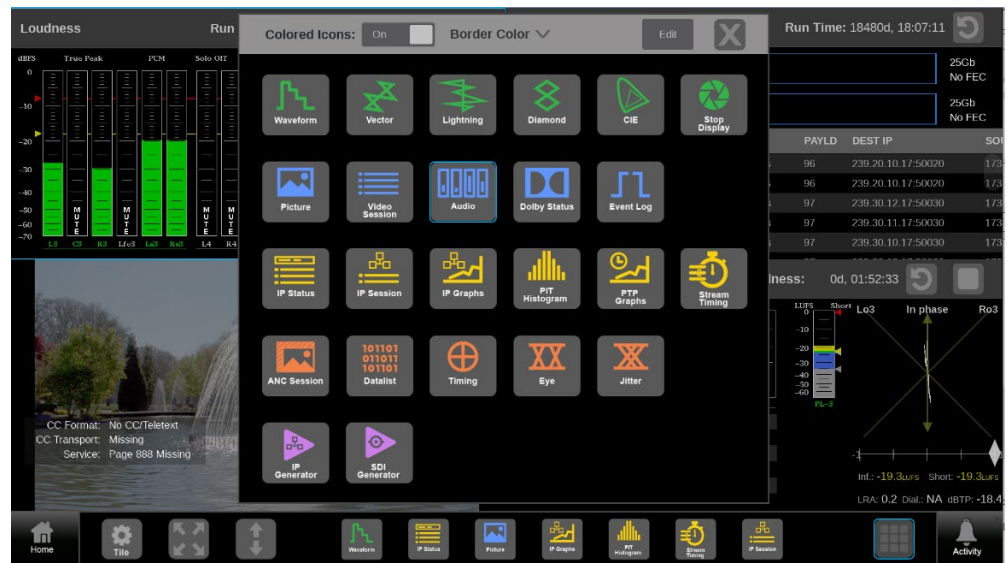

Figure 7: PRISM application menu

Supported touchscreen gestures

You can use these touchscreen gestures to control the instrument:







- Touch or tap the screen to select display elements.
- Double tap an application banner to change the display between tile and a full-screen display of the selected application.
- Swipe up or down, or left or right as necessary to go to menus and preset listings and to

view additional application information.

- Some applications support pinch and zoom.

Note: The terms “tap,” “swipe,” and “pinch” apply to the touchscreen on the instrument. If you are using a mouse and keyboard you must “click,” “scroll,” and use the scroll wheel on the mouse.

Select or control an application to display

1. Select the  icon to open the application tool bar.
2. Select an application from the application tool bar to open the application.
3. If an application is not available on the application tool bar, select the  icon, at the right of the application tool bar, to open the application menu, which shows all available applications, and select the application. See Figure 7.
4. In the application menu, select **Edit** to change the applications available in the application tool bar. Up to 8 applications can be listed on the application tool bar. The number notes the location of the application on the application tool bar.
 - Click an application marked with a number to remove it from the application tool bar.
 - Click an application that is not marked with a number to add it to an empty space in the application tool bar.
5. Select the application in a tile and then select the  icon in the application tool bar to open the settings menu for the application.
6. Select the  icon in the menu bar to change the selected application display to full screen.
7. Select the  icon in the menu bar to change the selected application display to vertical extended mode. The vertical extended mode is useful for when you want to view two application displays side-by-side. When an application display is in vertical extended mode, select the  icon in the menu bar to return to quarter tile mode.
8. If available, select the  icon to clear or reset the selected display.

Remote control through VNC operation

When the PRISM monitor is connected to an Ethernet network, you can use a computer connected to the same network to remotely control the instrument in a web browser or in a VNC client, such as VNC Viewer. Connect to the PRISM monitor by using VNC:

VNC client. When using VNC for extended periods of time, we recommend using a VNC client:

1. On the PRISM monitor to connect to, select **Settings** and then select **Network**.
2. Find the Control IP Port IP address of the instrument.
3. On your computer, open your VNC client and enter the IP address of the Control IP Port of the instrument in the VNC Server search bar.

Note: A unique PRISM Hostname can be used instead of the IP address. To set a Hostname, select

Settings and then select **Network**, and select the **Web Remote** tab.

The VNC client connects to the instrument in a separate window that appears exactly like the instrument display.

Web browser: To connect to the instrument through a web browser:

1. On the PRISM monitor to connect to, select **Settings**, then select **Network**, and find the Control IP Port IP address of the instrument.
2. In a web browser, enter the address
<http://xxx.xxx.xxx.xxx:6080/vnc.html>
where xxx.xxx.xxx.xxx is the IP address of the Control IP Port of the instrument.

Note: If you have set a unique Hostname for the instrument, enter it in the browser address bar and select the **noVNC Access** link.

This opens a login web page. (See Figure 8.)



Figure 8: noVNC login web page

3. In the Control bar, click the **Settings** icon () to open the Settings menu. (See Figure 9.)
4. In the Settings menu, open the **Scaling Mode** drop-down list to select **Local Scaling**, and then click **Apply**.

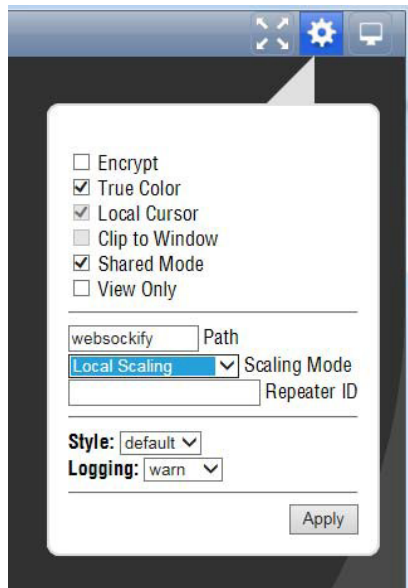



Figure 9: noVNC Settings menu

5. In the Control bar, click the **Connect** icon () to open the Connect menu. (See Figure 10.)

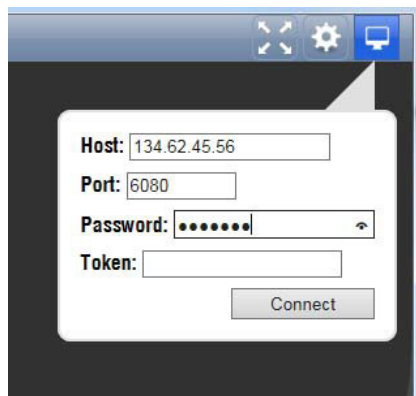

Figure 10: noVNC Connect menu

6. In the Connect menu, enter the default password **PRISM**, and then click **Connect**.

Note: A unique PRISM hostname can be used instead of the IP address. To set a hostname, select **Settings**, then select **Network**, and select the **Web Remote** tab.

The web browser connects to the instrument with the browser display appearing exactly like the display on the external monitor. (See Figure 11.)

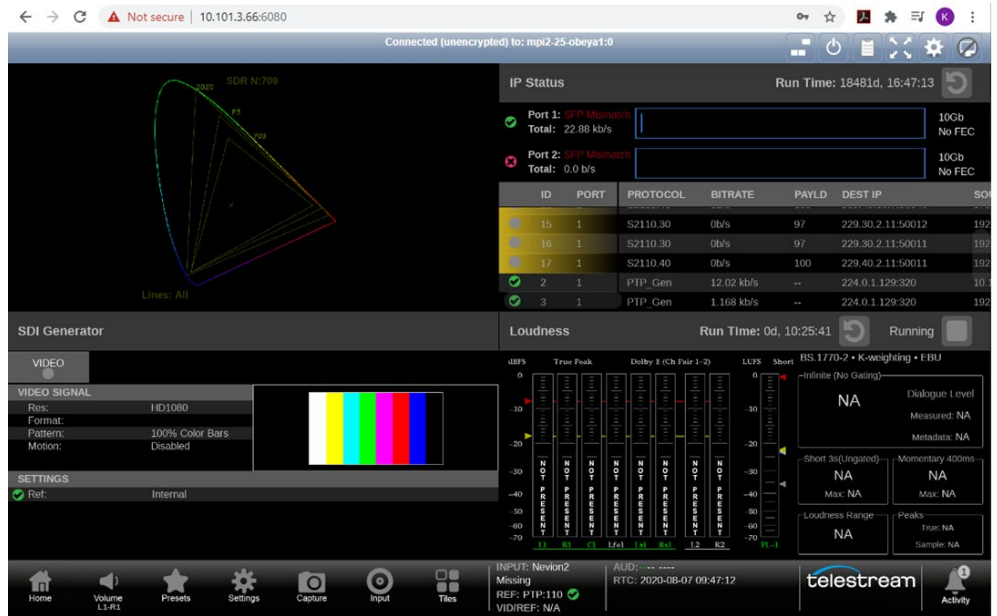

Figure 11: PRISM browser display