



**PRISM MPD
SDI / IP Waveform Monitor
Installation and Safety Instructions**

Copyrights and Trademark Notices

Copyright © 2022 Telestream, LLC and its Affiliates. All rights reserved. TELESTREAM is a registered trademark of Telestream, LLC. All other trade names referenced are the service marks, trademarks, or registered trademarks of their respective companies.

Telestream products are covered by U.S. and foreign patents, issued and pending. Information in this publication supersedes that in all previously published material. Specifications and price change privileges reserved.

TELESTREAM is a registered trademark of Telestream, LLC.

Blender: Images from Big Buck Bunny used without modification under the Creative Commons Attribution 3.0 license. (c) copyright 2008, Blender Foundation / <http://peach.blender.org/about/>.

Dolby: Dolby and the double-D symbol are registered trademarks of Dolby Laboratories.

Warranty

Telestream on behalf of itself and its Affiliates (“Telestream”) warrants that this product will be free from defects in materials and workmanship for a period of one (1) year from the date of shipment. If any such product proves defective during this warranty period, Telestream, at its option, either will repair the defective product without charge for parts and labor, or will provide a replacement in exchange for the defective product. Parts, modules and replacement products used by Telestream for warranty work may be new or reconditioned to like new performance. All replaced parts, modules and products become the property of Telestream.

In order to obtain service under this warranty, Customer must notify Telestream of the defect before the expiration of the warranty period and make suitable arrangements for the performance of service. Customer shall be responsible for packaging and shipping the defective product to the service center designated by Telestream, with shipping charges prepaid. Telestream shall pay for the return of the product to Customer if the shipment is to a location within the country in which the Telestream service center is located. Customer shall be responsible for paying all shipping charges, duties, taxes, and any other charges for products returned to any other locations.

This warranty shall not apply to any defect, failure or damage caused by improper use or improper or inadequate maintenance and care. Telestream shall not be obligated to furnish service under this warranty a) to repair damage resulting from attempts by personnel other than Telestream representatives to install, repair or service the product; b) to repair damage resulting from improper use or connection to incompatible equipment; c) to repair any damage or malfunction caused by the use of non- Telestream supplies; or d) to service a product that has been modified or integrated with other products when the effect of such modification or integration increases the time or difficulty of servicing the product.

THIS WARRANTY IS GIVEN BY TELESTREAM WITH RESPECT TO THE PRODUCT IN LIEU OF ANY OTHER WARRANTIES, EXPRESS OR IMPLIED. TELESTREAM AND ITS VENDORS

DISCLAIM ANY IMPLIED WARRANTIES OF MERCHANTABILITY OR FITNESS FOR A PARTICULAR PURPOSE. TELESTREAM'S RESPONSIBILITY TO REPAIR OR REPLACE DEFECTIVE PRODUCTS IS THE SOLE AND EXCLUSIVE REMEDY PROVIDED TO THE CUSTOMER FOR BREACH OF THIS WARRANTY. TELESTREAM AND ITS VENDORS WILL NOT BE LIABLE FOR ANY INDIRECT, SPECIAL, INCIDENTAL, OR CONSEQUENTIAL DAMAGES IRRESPECTIVE OF WHETHER TELESTREAM OR THE VENDOR HAS ADVANCE NOTICE OF THE POSSIBILITY OF SUCH DAMAGES.

[W2 – 15AUG04]

TELESTREAM SOFTWARE LICENSE AGREEMENT

THE PROGRAM, OR PROGRAMS, ENCODED OR INCORPORATED WITHIN EQUIPMENT OR ACCOMPANYING THIS AGREEMENT, IS FURNISHED SUBJECT TO THE TERMS AND CONDITIONS OF THIS AGREEMENT. RETENTION OF THE PROGRAM FOR MORE THAN THIRTY DAYS OR USE OF THE PROGRAM IN ANY MANNER WILL BE CONSIDERED ACCEPTANCE OF THE AGREEMENT TERMS. IF THESE TERMS ARE NOT ACCEPTABLE, THE UNUSED PROGRAM AND ANY ACCOMPANYING DOCUMENTATION SHOULD BE RETURNED PROMPTLY TO TELESTREAM FOR A FULL REFUND OF THE LICENSE FEE PAID. (FOR INFORMATION REGARDING THE RETURN OF PROGRAMS ENCODED OR INCORPORATED WITHIN EQUIPMENT, CONTACT THE NEAREST TELESTREAM SALES OFFICE.)

DEFINITIONS

"Telestream" means Telestream, LLC, a Delaware limited liability company, and its Affiliates, or the local Telestream legal entity that is supplying the equipment.

"Program" means the Telestream software product (executable program and/or data) enclosed with this Agreement or included within the equipment with which this Agreement is packed. "Customer" means the person or organization in whose name the Program was ordered.

LICENSE

Customer may:

1. Use the Program on a single machine at any one time; and
2. Copy the Program for archival or backup purposes, provided that no more than one (1) such copy is permitted to exist at any one time. Each copy of the Program made by Customer must include a reproduction of any copyright notice or restrictive rights legend appearing in or on the copy of the Program as received from Telestream.

Customer may not:

1. Use the Program on more than one machine at any one time;
2. Transfer the Program to any person or organization outside of Customer or the corporation of which Customer is a part without the prior written consent of Telestream, except in connection with the transfer of the equipment within which the programs are encoded or incorporated;

3. Export or re-export, directly or indirectly, the program, any associated documentation, or the direct product thereof, to any country to which such export or re-export is restricted by law or regulation of the United States or any foreign government having jurisdiction without the prior authorization, if required, of the Office of Export Administration, Department of Commerce, Washington, D.C. and the corresponding agency of such foreign government;
4. Modify the Program, create derivative works, or merge the Program with another program;
5. Reverse compile or disassemble the Program for any purpose, beyond the extent that such activity is expressly permitted by applicable open source licenses or applicable law notwithstanding this limitation; or
6. Copy the documentation accompanying the Program.

For Programs designed to reside on a single-machine and support one or more additional machines, either locally or remotely, without permitting the Program to be transferred to an additional machine for local execution, the additional machines shall be considered within the definition of "single machine." For programs permitting the Program to be transferred to an additional machine for local execution, a separate license shall be required for each such machine with which the Program may be used. Title to the Program and all copies thereof, but not the media on which the Program or copies may reside, shall be and remain with Telestream or others for whom Telestream has obtained a respective licensing right. Customer shall pay when due all property taxes that may now or hereafter be imposed, levied or assessed with respect to the possession or use of the Program or this license and shall file all reports required in connection with such taxes. If the Program or any related documentation is acquired by or for an agency of the U.S. Government, the Program and documentation shall be considered "commercial computer software" or "commercial computer software documentation" respectively, as those terms are used in 48 CFR §12.212, 48 CFR §227.7202, or 48 CFR §252.227-7014, and are licensed with only those rights as are granted to all other licensees as set forth in this Agreement.

THE PROGRAM MAY NOT BE USED, COPIED, MODIFIED, MERGED, OR TRANSFERRED TO ANOTHER EXCEPT AS EXPRESSLY PERMITTED BY THESE TERMS AND CONDITIONS. UPON TRANSFER OF ANY COPY, MODIFICATION, OR MERGED PORTION OF THE PROGRAM, THE LICENSE GRANTED HEREIN IS AUTOMATICALLY TERMINATED WITH RESPECT TO THE PARTY THAT TRANSFERS THE PROGRAM.

TERM

The license granted herein is effective upon acceptance by Customer, and shall remain in effect until terminated as provided herein. The license may be terminated by Customer at any time upon written notice to Telestream. The license may be terminated by Telestream or any third party from whom Telestream may have obtained a respective licensing right if Customer fails to comply with any term or condition and such failure is not remedied within thirty (30) days after notice hereof from Telestream or such third party. Upon termination by either party, Customer shall return to Telestream or destroy, the Program and all associated documentation, together with all copies in any form.

LIMITED WARRANTY

The Program is provided "as is" without warranty of any kind, either express or implied. Telestream does not warrant that the functions contained in the Program will meet Customer's requirements or that the operation of the Program will be uninterrupted or error-free.

TELESTREAM AND ITS VENDORS DISCLAIM ANY IMPLIED WARRANTIES OF MERCHANTABILITY OR FITNESS FOR A PARTICULAR PURPOSE. LIMITATION OF LIABILITY, IN NO EVENT SHALL TELESTREAM OR OTHERS FROM WHOM TELESTREAM HAS OBTAINED A LICENSING RIGHT BE LIABLE FOR ANY INDIRECT, SPECIAL, INCIDENTAL, OR CONSEQUENTIAL DAMAGES ARISING OUT OF OR CONNECTED WITH CUSTOMER'S POSSESSION OR USE OF THE PROGRAM, EVEN IF TELESTREAM OR SUCH OTHERS HAS ADVANCE NOTICE OF THE POSSIBILITY OF SUCH DAMAGES.

THIRD-PARTY DISCLAIMER

Except as expressly agreed otherwise, third parties from whom Telestream may have obtained a licensing right do not warrant the program, do not assume any liability with respect to its use, and do not undertake to furnish any support or information relating thereto.

GENERAL

This Agreement contains the entire agreement between the parties with respect to the use, reproduction, and transfer of the Program. Neither this Agreement nor the license granted herein is assignable or transferable by Customer without the prior written consent of Telestream. This Agreement and the license granted herein shall be governed by the laws of the state of California. All questions regarding this Agreement or the license granted herein should be directed to the nearest Telestream Sales Office.

Table of Contents

Important Compliance and Safety Information	7
Preface	21
Product Description	21
Where to Find More Information	22
Conventions Used in this Manual	23
Telestream Contact Information	23
Installation	24
Initial Product Inspection	24
Accessories	26
Operating Requirements	27
MPD Rack Installation	30
Connectors	32
Operation	38
Power-on and Power-off Procedures	38
Display Elements	40
Methods of Operation	42

Important Compliance and Safety Information

United States of America Compliance Notices

Class A Interference Statement

This equipment has been tested and found to comply with the limits for a Class A digital device, pursuant to Part 15, Subpart B of the FCC Rules. These limits are designed to provide reasonable protection against harmful interference in a commercial installation. This equipment generates, uses, and can radiate radio frequency energy and, if not installed and used in accordance with the instructions, may cause harmful interference to radio communications. However, there is no guarantee that interference will not occur in a particular installation. Operation of this equipment in a residential area is likely to cause harmful interference in which case the user will be required to correct the interference at his own expense.

FCC Caution

This device complies with Part 15 of the FCC Rules. Operation is subject to the following two conditions:

1. This device may not cause harmful interference, and
2. This device must accept any interference received, including interference that may cause undesired operation.

Safety

UL 61010-1: 2012 R7.19: Safety Requirements for Electrical Equipment for Measurement, Control, and Laboratory Use - Part 1: General Requirements.

Environmental

Perchlorate Materials: this product contains one or more type CR lithium batteries. According to the state of California, CR lithium batteries are classified as perchlorate materials and require special handling.

See www.dtsc.ca.gov/hazardouswaste/perchlorate for additional information.

Canada Compliance Notices

Department of Communications Radio Interference Regulations

This digital apparatus does not exceed the Class A limits for radio-noise emissions from a digital apparatus as set out in the Radio Interference Regulations of the Canadian Department of Communications. This Class A digital apparatus complies with Canadian ICES-003.

Reglement sur le brouillage radioelectrique du Quadstere des Communications

Cet appareil numerique respecte les limites de bruits radioelectriques visant les appareils numeriques de classe A prescrites dans le Reglement sur le brouillage radioelectrique du Quadstere des Communications du Canada. Cet appareil numerique de la Classe A est conforme a la norme NMB-003 du Canada.

Safety

CAN/CSA-C22.2 NO. 61010-1-12 + G11 + G12 (R2017) + A1: Safety Requirements for Electrical Equipment for Measurement, Control, and Laboratory Use - Part 1: General Requirements.

Sécurité

CAN/CSA-C22.2 NO. 61010-1-12 + G11 + G12 (R2017) + A1: Exigences de sécurité pour l'électricité Matériel de mesure, de contrôle et d'utilisation en laboratoire - Partie 1: Généralités Exigences.

European Union and European Free Trade Association (EFTA) Compliance Notices

This equipment may be operated in the countries that comprise the member countries of the European Union and the European Free Trade Association. These countries, listed in the following paragraph, are referred to as The European Community throughout this document:

AUSTRIA, BELGIUM, BULGARIA, CYPRUS, CZECH REPUBLIC, DENMARK, ESTONIA, FINLAND, FRANCE, GERMANY, GREECE, HUNGARY, IRELAND, ITALY, LATVIA, LITHUANIA, LUXEMBOURG, MALTA, NETHERLANDS, POLAND, PORTUGAL, ROMANIA, SLOVAKIA, SLOVENIA, SPAIN, SWEDEN, UNITED KINGDOM, ICELAND, LICHTENSTEIN, NORWAY, SWITZERLAND

Declaration of Conformity

Marking by the "CE" symbol indicates compliance with the Essential Requirements of the EMC Directive of the European Union 2014/30/EU

This equipment meets the following conformance standards:

Safety

EN 61010-1: 2010 + A1: Safety Requirements for Electrical Equipment for Measurement, Control, and Laboratory Use - Part 1: General Requirements Low Voltage Directive 2014/35/EU

Emissions

EN 55032: 2015 + A11: 2020, CISPR 32: 2015, EN 61000-3-2: 2014, EN 61000-3-3: 2013

Immunity

EN 55035: 2017, EN 61000-4-2: 2009,

EN 61000-4-3: 2006 + A1: 2008 + A2: 2010, EN 61000-4-4: 2012,

EN 61000-4-5: 2014 + A1: 2017, EN 61000-4-6: 2014, EN 61000-4-8: 2010,

EN 61000-4-11: 2020

Environments: E2

Warnings



Warning! This is a Class A product. In a domestic environment, this product may cause radio interference, in which case, the user may be required to take appropriate measures.



Achtung! Dieses ist ein Gerat der Funkstorgrenzwertklasse A. In Wohnbereichen können bei Betrieb dieses Gerates Rundfunkstörungen auftreten, in welchen Fallen der Benutzer für entsprechende Gegenmaßnahmen verantwortlich ist.



Attention! Ceci est un produit de Classe A. Dans un environnement domestique, ce produit risque de créer des interférences radioélectriques, il appartiendra alors à l'utilisateur de prendre les mesures spécifiques appropriées.

Notes:

1. For Compliance with the EMC standards listed here, high quality shielded interface cables should be used.
2. Emissions which exceed the levels required by this standard may occur when this equipment is connected to a test object.

Environmental Compliance

This section provides information about the environmental impact of the product.

Product end-of-life handling

Observe the following guidelines when recycling an instrument or component:

Equipment recycling



Production of this equipment required the extraction and use of natural resources. The equipment may contain substances that could be harmful to the environment or human health if improperly handled at the product's end of life. To avoid release of such substances into the environment and to reduce the use of natural resources, we

encourage you to recycle this product in an appropriate system that will ensure that most of the materials are reused or recycled appropriately.

This symbol on the product or its packaging indicates that this product complies with the applicable European Union requirements according to Directives 2012/19/EU and 2006/66/EC on waste electrical and electronic - equipment (WEEE) and batteries.

It also indicates that this product must not be disposed of with your other household waste. Instead, it is your responsibility to dispose of your waste equipment by handing it over to a designated collection point for the recycling of waste electrical and electronic equipment. The separate collection and recycling of your waste equipment at the time of disposal will help conserve natural resources and ensure that it is recycled in a manner that protects human health and the environment. For more information about where you can drop off your waste for recycling, please contact your local authority, or where you purchased your product.

Battery Recycling

This product may contain a rechargeable battery, which must be recycled or disposed of properly. Please properly dispose of or recycle the battery according to local government regulations.

Transporting Batteries or products with Batteries in them

The capacity of the lithium ion secondary battery shipped with this product is under 100 Wh. The lithium content of the installed primary battery is under 1 g. Each battery meets the applicable requirements of UN Manual of Tests and Criteria Part III Section 38.3. Battery quantity is under the limit for shipment according to Section II of the relevant Packing Instructions from the IATA Dangerous Goods Regulations. Consult your air carrier for applicability and determination of any special lithium battery transportation requirements.

Restriction of Hazardous Substances

This product is classified as an industrial monitoring and control instrument, and is not required to comply with the substance restrictions of the RoHS 3 Directives 2011 /65/ EU and EU 2015/863 until July 22, 2021. This product does, however, comply with the RoHS 2 Directive 2011/65/EU.

Korea Compliance Statement

사 용 자 안 내 문
이 기기는 업무용 환경에서 사용할 목적으로 적합성평가를 받은 기기로서 가정용 환경에서 사용하는 경우 전파간섭의 우려가 있습니다.

Taiwan Compliance Statement

 使用者：
這是甲類的資訊產品，在居住的環境中使用時，可能會造成射頻干擾，在這種情況下，使用者會被要求採取某些適當的對策。

This is a Class A product based on the standard of the Bureau of Standards, Metrology and Inspection (BSMI) CNS 13438, Class A. In a domestic environment this product may cause radio interference in which case the user may be required to take adequate measures.

Japan Compliance Statement

 の装置は、クラスA情報技術装置です。この装置を家庭環境で使用すると電波妨害を引き起こすことがあります。この場合には使用者が適切な対策を講ずるよう要求されることがあります。 VCCI-A

This is a Class A product based on the standard of the VCCI Council (VCCI 32: 2016). If this equipment is used in a domestic environment, radio interference may occur, in which case, the user may be required to take corrective actions.

Important Safety Information

This manual contains information and warnings that must be followed by the user for safe operation and to keep the product in a safe condition. To safely perform service on this product, see the Service safety summary that follows the General safety summary.

General Safety Summary

Use the product only as specified. Review the following safety precautions to avoid injury and prevent damage to this product or any products connected to it. Carefully read all instructions. Retain these instructions for future reference.

Comply with local and national safety codes.

For correct and safe operation of the product, it is essential that you follow generally accepted safety procedures in addition to the safety precautions specified in this manual.

The product is designed to be used by trained personnel only.

Only qualified personnel who are aware of the hazards involved should remove the cover for repair, maintenance, or adjustment. Before use, always check the product with a known source to be sure it is operating correctly.

While using this product, you may need to access other parts of a larger system. Read the safety sections of the other component manuals for warnings and cautions related to operating the system.

When incorporating this equipment into a system, the safety of that system is the responsibility of the assembler of the system.

To Avoid Fire or Personal Injury

Use proper power cord: Use only the power cord specified for this product and certified for the country of use. Do not use the provided power cord for other products.

Ground the product: This product is grounded through the grounding conductor of the power cord. To avoid electric shock, the grounding conductor must be connected to earth ground. Before making connections to the input or output terminals of the product, ensure that the product is properly grounded. Do not disable the power cord grounding connection.

Power disconnect: The power cord disconnects the product from the power source. See instructions for the location. Do not position the equipment so that it is difficult to operate the power cord; it must remain accessible to the user at all times to allow for quick disconnection if needed.

Observe all terminal ratings: To avoid fire or shock hazard, observe all rating and markings on the product. Consult the product manual for further ratings information before making connections to the product. Do not apply a potential to any terminal, including the common terminal, that exceeds the maximum rating of that terminal.

Do not operate without covers: Do not operate this product with covers or panels removed, or with the case open. Hazardous voltage exposure is possible.

Avoid exposed circuitry: Do not touch exposed connections and components when power is present.

Do not operate with suspected failures: If you suspect that there is damage to this product, have it inspected by qualified service personnel.

Disable the product if it is damaged. Do not use the product if it is damaged or operates incorrectly. If in doubt about safety of the product, turn it off and disconnect the power cord. Clearly mark the product to prevent its further operation.

Before use, inspect voltage probes, test leads, and accessories for mechanical damage and replace when damaged. Do not use probes or test leads if they are damaged, if there is exposed metal, or if a wear indicator shows.

Examine the exterior of the product before you use it. Look for cracks or missing pieces.

Use only specified replacement parts.

Do not operate in wet/damp conditions: Be aware that condensation may occur if a unit is moved from a cold to a warm environment.

Do not operate in an explosive atmosphere.

Keep product surfaces clean and dry: Remove the input signals before you clean the product.

Provide proper ventilation: Refer to the manual's installation instructions for details on installing the product so it has proper ventilation.

Slots and openings are provided for ventilation and should never be covered or otherwise obstructed. Do not push objects into any of the openings.

Provide a safe working environment: Always place the product in a location convenient for viewing the display and indicators.

Be sure your work area meets applicable ergonomic standards. Consult with an ergonomics professional to avoid stress injuries.

Use only the Telestream rackmount hardware specified for this product.

Service Safety Summary

The Service safety summary section contains additional information required to safely perform service on the product. Only qualified personnel should perform service procedures. Read this Service safety summary and the General safety summary before performing any service procedures.

To avoid electric shock: Do not touch exposed connections.

Do not service alone: Do not perform internal service or adjustments of this product unless another person capable of rendering first aid and resuscitation is present.

Disconnect power: To avoid electric shock, switch off the product power and disconnect the power cord from the mains power before removing any covers or panels, or opening the case for servicing.

Use care when servicing with power on: Dangerous voltages or currents may exist in this product. Disconnect power, remove battery (if applicable), and disconnect test leads before removing protective panels, soldering, or replacing components.

Verify safety after repair: Always recheck ground continuity and mains dielectric strength after performing a repair.

Terms in Manual

These terms may appear in this manual:



WARNING: Warning statements identify conditions or practices that could result in injury or loss of life.



CAUTION: Caution statements identify conditions or practices that could result in damage to this product or other property.

Terms on Product

These terms may appear on the product:

DANGER indicates an injury hazard immediately accessible as you read the marking.

WARNING indicates an injury hazard not immediately accessible as you read the marking.

CAUTION indicates a hazard to property including the product.

Symbols on the Product

When this symbol is marked on the product, be sure to consult the manual to find out the nature of the potential hazards and any actions which have to be taken to avoid them. (This symbol may also be used to refer the user to ratings in the manual.)

The following symbol(s) may appear on the product:



General Safety Product Specific Statements

Use the product only as specified. Review the following safety precautions to avoid injury and prevent damage to this product or any products connected to it.

Carefully read all instructions. Retain these instructions for future reference.

Comply with local and national safety codes.

For correct and safe operation of the product, it is essential that you follow generally accepted safety procedures in addition to the safety precautions specified in this manual. The product is designed to be used by trained personnel only.

Only qualified personnel who are aware of the hazards involved should remove the cover for repair, maintenance, or adjustment.

Before use, always check the product with a known source to be sure it is operating correctly.

This product is not intended for detection of hazardous voltages.

Use personal protective equipment to prevent shock and arc blast injury where hazardous live conductors are exposed.

When incorporating this equipment into a system, the safety of that system is the responsibility of the assembler of the system.

 **WARNING: To prevent injury or death, power off the instrument and disconnect it from line voltage before cleaning.**

ADVERTENCIA: Para evitar el riesgo de lesión o muerte, apague el equipo y desconéctelo de la toma de corriente antes de limpiarlo.

WARNUNG: Um Verletzungen oder Tod zu vermeiden, schalten Sie das Gerät aus und trennen Sie es von der Netzspannung, bevor Sie es reinigen.

ATTENTION: Afin de prévenir de tout risque de blessure ou mort, veuillez éteindre et déconnecter l'appareil du secteur avant de le nettoyer.

AVVERTIMENTO: Per prevenire lesioni o morte dell'operatore, spegnere lo strumento e scollegarlo dalla presa di corrente prima di qualsiasi operazione di pulizia.

AVISO: Para evitar risco de lesão ou morte, desligue o instrumento e desconecte-o da corrente antes de limpá-lo.



WARNING: To reduce the risk of fire and shock, ensure that the mains supply voltage fluctuations do not exceed 10% of the operating voltage range.

ADVERTENCIA: Para evitar el riesgo de fuego y descargas, asegúrese de que las fluctuaciones de voltaje de la fuente de alimentación no exceden 10% del rango operativo de voltaje.

WARNUNG: Um die Brand- und Stromschlaggefahr zu verringern, stellen Sie sicher, dass die Schwankungen der Netzspannung 10% des Betriebsspannungsbereichs nicht überschreiten.

ATTENTION: Pour éviter tout risque de feu ou choc électrique, assurez vous que les variations de tension ne soient pas supérieure à 10% de la valeur nominale.

AVVERTIMENTO: Per ridurre il pericolo di incendi e folgorazioni, assicurarsi che le fluttuazioni della tensione di rete siano contenute entro il 10% del valore nominale.

AVISO: Para reduzir o risco de incêndio e choque, certifique-se de que as flutuações da voltagem da rede elétrica não excedam 10% da faixa de tensão de operação.



WARNING: In the instrument, only the line conductor is fused for over-current protection. The fuse is internal and not user replaceable. Do not attempt to replace the fuse. If you suspect the fuse has blown, return the unit to an authorized service center for repair.

ADVERTENCIA: En el equipo, solo el conductor de línea lleva fusible como protección de sobrecarga. El fusible es interno y no reemplazable por el usuario. No intente cambiar el fusible. Si sospecha que el fusible no está conduciendo corriente, devuelva el equipo a un centro de servicio autorizado para su reparación.

WARNUNG: Im Gerät ist nur der Netzleiter zum Schutz gegen Überstrom abgesichert. Die Sicherung ist fest verbaut und kann nicht vom Benutzer ausgetauscht werden. Versuchen Sie nicht, die Sicherung zu ersetzen. Wenn Sie den Verdacht haben, dass die Sicherung defekt ist, bringen Sie das Gerät zur Reparatur in ein autorisiertes Servicezentrum.

ATTENTION: Dans l'instrument seul le secteur a une protection contre les court circuit (ou sur tension). Le fusible est à l'intérieur du matériel et ne peut pas être remplacé par l'utilisateur. N'essayez pas de le remplacer. Si vous suspectez le fusible, veuillez renvoyer le matériel dans un centre de réparation agréé.

AVVERTIMENTO: Lo strumento è protetto con un fusibile sul conduttore della fase. Il fusibile è interno e non può essere sostituito dall'utente. Non tentare di sostituire il fusibile. Se pensate che il fusibile si sia bruciato, inviate l'unità a un centro di assistenza autorizzato per la riparazione.

AVISO: No instrumento, apenas o condutor da linha possui fusível para proteção contra sobrecorrente. O fusível é interno e não pode ser substituído pelo utilizador. Não tente substituir o fusível. Se suspeitar que o fusível não está conduzindo corrente, devolva a unidade a um centro de serviço autorizado para reparação.



WARNING: To prevent injury or damage to the instrument, do not carry the PRISM by the small handles on the front of the instrument. These handles are for pulling the instrument out of a rack installation and are not intended to be used for carrying the instrument.

ADVERTENCIA: Para evitar lesión o daños al equipo, no sujete el monitor PRISM por las asas del frente del equipo. Estas asas son para sacar el equipo de una instalación de rack y no están diseñadas para sujetarlo.

WARNUNG: Um Verletzungen oder Schäden am Gerät zu vermeiden, sollten Sie den PRISM Monitor nicht an den Griffen an der Vorderseite des Geräts tragen. Diese Griffe dienen zum Herausziehen des Geräts aus einer Rack-Installation und sind nicht zum Tragen des Geräts gedacht.

ATTENTION: Afin d'éviter tout dommage ou casse de matériel ne pas porter le PRISM avec les anses de devant. Celle-ci servent à retirer le matériel du rack et ne servent pas à le porter.

AVVERTIMENTO: Per evitare lesioni o danni allo strumento, non utilizzate le maniglie frontali per trasportare l'apparato. Queste maniglie servono esclusivamente per estrarre lo strumento dal rack e non sono idonee al trasporto dello strumento.

AVISO: Para evitar ferimentos ou danos ao instrumento, não transporte o monitor PRISM pela pega na parte frontal do instrumento. Estas pegas são para puxar o instrumento para fora de uma instalação em rack e não se destinam ao transporte do instrumento.



CAUTION: To reduce risk of fire and shock, use the certified power cord provided with the product.

PRECAUCIÓN: Para evitar riesgo de incendio o descarga, use el cable de alimentación certificado que se suministró con el equipo.

VORSICHT: Um die Gefahr von Feuer und Stromschlag zu verringern, verwenden Sie das mit dem Gerät gelieferte zertifizierte Netzkabel.

AVERTIR: Pour réduire le risque d'incendie et de choc électrique, veuillez utiliser un cordon secteur certifié.

ATTENZIONE: Per ridurre il rischio di incendi e folgorazioni, utilizzare il cavo di alimentazione certificato fornito con il prodotto.

CAUTION: Para reduzir o risco de incêndio e choque, use o cabo de alimentação certificado fornecido com o produto.



CAUTION: Damage to the instrument can occur if this instrument is powered on at temperatures outside the specified temperature range.

PRECAUCIÓN: Hay peligro de daños al equipo si se enciende a temperaturas que estén fuera del rango especificado.

VORSICHT: Das Gerät kann beschädigt werden, wenn es bei Temperaturen außerhalb des angegebenen Temperaturbereichs eingeschaltet wird.

AVERTIR: Des dommages peuvent être produits par la mise sous tension dans des plages de température en dehors des valeurs spécifiées.

ATTENZIONE: Non accendere lo strumento se la temperatura ambiente è al di fuori dell'intervallo specificato in quanto si possono provocare danni.

CAUTION: Podem ocorrer danos ao instrumento se este for ligado em temperaturas fora da faixa de temperatura especificada.



CAUTION: To minimize the risk of damage to the instrument, we strongly recommend the power cord be connected to the instrument before the power cord is connected to the AC power source.

PRECAUCIÓN: Para minimizar el riesgo de daños al equipo, se recomienda que el cable de alimentación se conecte al equipo antes de que se conecte a la fuente de alimentación de corriente alterna.

VORSICHT: Um das Risiko einer Beschädigung des Geräts zu minimieren, empfehlen wir dringend, das Netzkabel an das Gerät anzuschließen, bevor das Netzkabel an die Stromquelle angeschlossen wird.

AVERTIR: Pour minimiser les risques de dégâts, nous recommandons vivement que le cordon secteur soit d'abord connecté à l'instrument avant la source d'alimentation.

ATTENZIONE: Per ridurre al minimo il rischio di danni allo strumento, si consiglia vivamente di collegare il cavo di alimentazione allo strumento prima che il cavo di alimentazione sia collegato alla fonte di alimentazione CA.

CAUTION: Para minimizar o risco de danos ao instrumento, recomendamos fortemente que o cabo de alimentação seja conectado ao instrumento antes de conectá-lo à fonte de alimentação AC.



CAUTION: To prevent data loss, we strongly recommend you first shut down the instrument before disconnecting the power cord. Press the power button or select Settings, Utilities, Power, and then Power Down Now.

PRECAUCIÓN: Para evitar la pérdida de datos, se recomienda apagar el equipo antes de desconectar el cable de alimentación. Pulse el botón de encendido o seleccione en el menú *Settings, Utilities, Power, y Power Down Now*.

VORSICHT: Um Datenverluste zu vermeiden, empfehlen wir dringend, das Gerät erst auszuschalten, bevor Sie das Netzkabel abziehen. Drücken Sie die Netztaaste oder wählen Sie *Settings, Utilities, Power* und dann *Power Down Now*.

AVERTIR: Pour éviter des pertes de données, veuillez éteindre le matériel avant de déconnecter le secteur. Appuyer sur le bouton Power ou sélectionner *Settings, Utilities, Power* et *Power Down Now* dans le menu.

ATTENZIONE: Per prevenire la perdita di dati, si consiglia vivamente di spegnere lo strumento prima di scollegare il cavo di alimentazione. Premi il pulsante di accensione o seleziona *Settings, Utilities, Power*, quindi *Power Down Now*.

CUIDADO: Para evitar perda de dados, é altamente recomendável desligar o instrumento antes de desconectar o cabo de alimentação. Pressione o botão liga / desliga ou seleccione *Settings, Utilities, Power* e *Power Down Now*.



CAUTION: To prevent static damage to the SFP module, if you remove the SFP module from the instrument, always store and transport the SFP module in an anti-static bag or container.

PRECAUCIÓN: Para evitar daños producidos por electricidad estática, cuando quite un módulo SFP del equipo se recomienda guardarlo y transportarlo en una bolsa o contenedor antiestático.

VORSICHT: Um statische Schäden am SFP-Modul zu vermeiden, sollten Sie das SFP-Modul immer in einem antistatischen Beutel oder Behälter aufbewahren und transportieren, wenn Sie es aus dem Gerät entfernen.

AVERTIR: Pour éviter des problèmes d'électricité statique, si vous retirez le SFP de l'instrument, veuillez le stocker et le transporter dans un sac ant-statique.

ATTENZIONE: Se si rimuovono gli SFP dallo strumento, conservarli e trasportarli in una busta anti statica o altro contenitore idoneo in modo da evirare danni dovuti alla elettricità statica (ESD).

CUIDADO: Para evitar danos estáticos ao módulo SFP, se você remover o módulo SFP do instrumento, armazene e transporte sempre o módulo SFP em um saco ou recipiente antiestático.



CAUTION: To prevent possible damage to the PRISM monitor and SFP modules, remove the SFP modules before transporting the PRISM monitor.

PRECAUCIÓN: Para evitar posibles daños al monitor PRISM y los módulos SFP, se recomienda extraer los módulos SFP antes de transportar el monitor PRISM.

VORSICHT: Um eine mögliche Beschädigung des PRISM-Monitors und der SFP-Module zu vermeiden, entfernen Sie die SFP-Module, bevor Sie den PRISM-Monitor transportieren.

AVERTIR: Pour éviter tout problème au PRISM ou aux SFP, veuillez retirer ces derniers pour le transport.

ATTENZIONE: Rimuovere i moduli SFP prima di trasportare lo strumento in modo da prevenire possibili danni al PRISM e agli SFP.

CUIDADO: Para evitar possíveis danos ao monitor PRISM e aos módulos SFP, remova os módulos SFP antes de transportar o monitor PRISM.



CAUTION: Avoid the use of chemical cleaning agents that might damage the plastics used in the instrument. Use only deionized water when cleaning the front-panel buttons. For the rest of the instrument, use a 75% isopropyl alcohol solution as a cleaner and rinse with deionized water. Before using any other type of cleaner, consult your Telestream service center or representative.

PRECAUCIÓN: Evite el uso de agentes químicos de limpieza que puedan dañar los plásticos del equipo. Use sólo agua desionizada para limpiar los botones del panel frontal. Para el resto del equipo, use una solución de alcohol isopropílico 75% como limpiador, y aclare con agua desionizada. Antes de usar cualquier otro tipo de limpiador, consulte con su centro de reparación de Telestream o su agente.

VORSICHT: Vermeiden Sie die Verwendung von chemischen Reinigungsmitteln, die die im Gerät verwendeten Kunststoffe beschädigen könnten. Verwenden Sie zum Reinigen der Tasten auf der Vorderseite des Geräts nur entionisiertes Wasser. Verwenden Sie für den Rest des Geräts eine 75%ige Isopropylalkohol-Lösung als Reinigungsmittel und spülen Sie mit entionisiertem Wasser nach. Wenden Sie sich an Ihren Telestream-Kundendienst, bevor Sie ein anderes Reinigungsmittel verwenden.

AVERTIR: Evitez d'utiliser des produits chimiques pour le nettoyage, ils pourraient endommager les plastiques. Utilisez uniquement de l'eau déminéralisée pour nettoyer les boutons de face avant. Pour le reste de l'instrument de l'alcool isopropil à 75% convient. Rincer à l'eau déminéralisée ensuite. Avant d'utiliser tout autre produit veuillez contact votre représentant Telestream.

ATTENZIONE: Evitare l'uso di detergenti chimici che potrebbero danneggiare la plastica utilizzata nello strumento. Utilizzare solo acqua deionizzata per pulire i pulsanti del pannello anteriore. Per il resto dello strumento, utilizzare una soluzione di alcol isopropilico al 75% come detergente e risciacquare con acqua deionizzata. Prima di utilizzare qualsiasi altro tipo di detergente, consultare il centro di assistenza o il rappresentante Telestream.

CUIDADO: Evite o uso de agentes químicos de limpeza que possam danificar os plásticos usados no instrumento. Use apenas água desionizada ao limpar os botões do painel frontal. Para o restante do instrumento, use uma solução de álcool isopropílico 75% como limpador e enxágue com água desionizada. Antes de usar qualquer outro

tipo de produto de limpeza, consulte o seu centro de serviço ou representante Telestream.



CAUTION: Ambient air temperature near the equipment is not necessarily inlet air temperature. Damage to the instrument can occur if this equipment is powered on without sufficient access to cool air.

PRECAUCIÓN: La temperatura ambiente cercana al equipo no es necesariamente la temperatura de entrada de aire. Hay peligro de daños al equipo si se opera sin el suficiente acceso a aire fresco.

VORSICHT: Die Umgebungstemperatur in der Nähe des Geräts entspricht nicht unbedingt der Ansauglufttemperatur. Das Gerät kann beschädigt werden, wenn es ohne ausreichenden Zugang zu kühler Luft eingeschaltet wird.

AVERTIR: La température de l'air ambiant n'est nécessairement celle à l'intérieure de l'appareil. Pour assurer un bon fonctionnement de ce dernier, veuillez vous assurer d'une bonne ventilation du matériel. Sans cela des dégâts pourraient apparaître.

ATTENZIONE: La temperatura dell'aria ambiente vicino all'apparecchiatura non è necessariamente la temperatura dell'aria in ingresso. Possono verificarsi danni allo strumento se questa apparecchiatura viene accesa senza un accesso sufficiente all'aria fredda.

CUIDADO: A temperatura do ar ambiente próximo ao equipamento não é necessariamente a temperatura do ar de entrada. Podem ocorrer danos ao instrumento se este equipamento for ligado sem acesso suficiente a ar frio.

Preface

This manual describes how to assemble and install the PRISM MPD SDI / IP Waveform Monitor. It also provides basic safety and operating information. Detailed operating information is available in the user manual. A complete list of PRISM documentation is provided in this manual.

Product Description

The PRISM SDI / IP Waveform Monitor provides flexible options and field-installable upgrades to monitor a diverse variety of SDI and IP statistics as well as video and audio content. The comprehensive feature set, along with an intuitive and simplified graphical presentation of IP statistics, including video quality and diagnostic information, enables engineers to ensure the delivery of superior QoS levels in an increasingly complex broadcast environment involving compressed / uncompressed video transmission through SDI/IP signal paths. PRISM is an ideal solution for monitoring SDI/IP hybrid environments including master control rooms, production studios, OB vans, and signal contribution/distribution centers.

Features and Benefits of a Tool for IP/SDI Infrastructures

- A comprehensive analysis and monitoring tool for a hybrid IP / SDI broadcast systems that provides system evaluation for long term system quality monitoring and reporting
- Extensive IP monitoring solution for SMPTE 2022-6, 2110, PTP, and RTP streams
- Graphical displays that show the traffic present in the 10/25G Ethernet link, allowing engineers to understand what is on their network and to easily select the stream of interest
- Select a stream to view and monitor the content using the Picture, Waveform, and Audio applications, and listen to audio with headphones for conformance monitoring
- Detect IP packet errors, monitor the packet inter arrival time (PIT) and time stamped delay factor (TS-DF) to allow engineers to observe issues that may cause intermittent loss of Video, Audio or Data
- Monitor PTP trend graphs to ensure proper IP system setup for robust sync system
- Telestream patented timing display showing the relative timing of the input signal and PTP reference that makes facility timing easy
- 1 PPS output when the instrument is locked to a PTP reference

- Seamless switching to ensure proper SMPTE 2022 and 2110 redundant system operation API to control PRISM from system management software
- Multipoint or remote site monitoring allowing one engineer to quickly respond to issues from multiple points in the system Optional 10/25GbE line rate packet capture for offline analysis
- Optional SDI and ST2110 IP signal generators for testing new or changing facility configurations
- NMOS IS-04 / IS-05 support for network discovery and connection management

Features and Benefits of Tools for 4K/UHD, WCG, and HDR

- A comprehensive production tool set supporting 4K / WCG / HDR content creation
- SDI / IP hybrid interface supporting up to 8K resolution, up to 7680x4320p60 format support with 12G-SDI / Quad 3G-SDI interface, and up to 3840x2160p60 format with SMPTE 2022-6/7 and 2110.
- Stop display for monitoring video signals with a variety of transfer functions in a consistent manner
- Vector display equipped with a 3D LUT conversion, allowing operators to match skin tones of video signals to standard BT.709 vector locations and verify wide color gamut compatibility to BT.709 color gamut
- 12G-SDI physical layer measurements to check SDI signal quality and integrity

Where to Find More Information

The full User Manual, Release Notes, and other information about your product are available for download at www.telestream.net/video/resources.htm. The Product Documentation table lists all the documentation for the PRISM SDI / IP Waveform Monitor.

Product Documentation

Document	Manual type	Part number	Description
MPS-MPD User Manual	User	D00013488x	Provides detailed operating information.
Release Notes	Release Notes	D00010030x	Describes the new features, improvements, and limitations of the instrument firmware.
MPD Installation and Safety Instructions	User	P00010446x	Describes how to install a PRISM MPD instrument and provides basic safety and operating information.

Conventions Used in this Manual

The PRISM SDI / IP Waveform Monitor is also referred to as the "PRISM" throughout this manual.

Telestream Contact Information

To obtain product information, technical support, or provide comments on this guide, contact us using our web site, email, or phone number as listed below.

Resource	Contact Information
Telestream Video Support	Web Site: http://www.telestream.net/telestream-support Email: videosupport@telestream.net US and Canada Toll-free: 1-844-219-5329 Outside of US and Canada: 1-503-967-9833
Telestream	Web Site: www.telestream.net Sales and Marketing Email: info@telestream.net Telestream 848 Gold Flat Road, Suite 1 Nevada City, CA. USA 95959
International Distributor Support	Web Site: www.telestream.net See the Telestream Web site for your regional authorized Telestream distributor.
Telestream Technical Writers	Email: techwriter@telestream.net If you have comments or suggestions about improving this document, or other Telestream documents—or if you've discovered an error or omission, please email us.

Installation

This section describes how to remove the PRISM MPD SDI / IP Waveform Monitor from the shipping box and clean it. It provides detailed steps to prepare the hardware for installation in a rack. Basic operating methods are also listed.

Initial Product Inspection

Inspect the product when you receive your instrument:

1. Inspect the shipping carton for external damage, which may indicate damage to the instrument.
2. Remove the PRISM from the shipping carton and check the instrument has not been damaged in transit. Prior to shipment the instrument is thoroughly inspected for mechanical defects. The exterior should not have any scratches or impact marks.

Note: Save the shipping carton and packaging materials for instrument repackaging in case shipment becomes necessary.

3. Verify the shipping carton contains the instrument, the standard accessories, and product documentation.
4. Verify that all the product options you ordered are installed:
 - a. After you install and power-on the instrument, select the **Settings** icon.
 - b. Select the **Utilities** bar.
 - c. Select the **Options** bar.

The display lists all the installed product options (for example, MPSDP-IP-MEAS) and the license expiration dates. If an expiration reads "None" then the license will not expire.

Physical Characteristics

MPD-100/-200/-300 Physical characteristics of a bare instrument

Parameter	Description
Dimensions	
Height	13.30 cm (5.24 in.)
Width	44.50 cm (17.52 in.)
Depth (incl. connectors)	13.07 cm (5.15 in.) for MPD-100 BNC connectors 12.46 cm (4.91 in.) for MPD-200/-300 HD-BNC connectors
Weight	
Net	3.95 kg (8.7 lb)
Shipping	6.2 kg (13.7 lb)

Exterior Cleaning

The instrument exterior was inspected for debris when it was shipped. If necessary, you can clean the exterior of the instrument.

 **WARNING: To prevent injury or death, power off the instrument and disconnect it from line voltage before cleaning.**

Clean the exterior surfaces of the chassis with a dry lint-free cloth or a soft-bristle brush. If any dirt remains, use a cloth or swab dipped in a 75% isopropyl alcohol solution. Use a swab to clean narrow spaces around controls and connectors. Do not use abrasive compounds on any part of the instrument that may be damaged by it.

 **CAUTION: Avoid the use of chemical cleaning agents that might damage the plastics used in the instrument. Use only deionized water when cleaning the front-panel buttons. For the rest of the instrument, use a 75% isopropyl alcohol solution as a cleaner and rinse with deionized water. Before using any other type of cleaner, consult your Telestream service center or representative.**

Accessories

Standard and optional accessories

Accessory	Std	Opt	Part number
MPD Installation and Safety Instructions	√		P00010446x
Power cord	√		Various
Transceiver modules:		√	MP-SFP Opt. 10GESR
10G Ethernet short range (850 nm) transceiver module			
10G Ethernet long range (1310 nm) transceiver module		√	MP-SFP Opt. 10GELR
25G Ethernet short range (850 nm) transceiver module		√	MP-SFP Opt. 25GESR
25G Ethernet long range (1310 nm) transceiver module		√	MP-SFP Opt. 25GELR
Cable kits:			
HD-BNC to BNC adapter cables (package of 3)		√	MP-CBL Opt. HDBNC-BNC

Your instrument was shipped with one of these power cord options. Power cords for use in North America are UL listed and CSA certified. Cords for use outside North America are approved by at least one authority acceptable in the country to which the product is shipped.

PWR-CORD-NA-S15 – North America Power Cord, Straight 15A

PWR-CORD-EURO – Universal EUR power cord

PWR-CORD-CHN – China power cord

PWR-CORD-IN – India power cord

PWR-CORD-UK – United Kingdom power cord

PWR-CORD-BRZ – Brazil power cord

PWR-CORD-AUS – Australia power cord

PWR-CORD-CHE – Switzerland power cord

PWR-CORD-JPN – Japan power cord

PWR-CORD-NONE – No power cord or AC Adapter

 **CAUTION: To reduce risk of fire and shock, use the certified power cord provided with the product.**

Operating Requirements

This section provides the environmental and power operating requirements for safe operation of the instrument.

Environmental Operating Requirements

The location of the instrument must be in a range of temperature and humidity, with adequate ventilation.

Temperature Range

The instrument must be within the range of temperatures listed in the Environmental Requirements table for safe operation or storage.

 **CAUTION: Damage to the instrument can occur if this instrument is powered on at temperatures outside the specified temperature range.**

Environmental Requirements

Parameter		Description
Temperature	Operating	0 °C to +40 °C
	Non-Operating	-20 °C to +60 °C
Humidity	Operating	20% to 80% relative humidity (% RH) at up to +40 °C, non-condensing
	Non-Operating	5% to 90% relative humidity (% RH) at up to 40 °C and derated linearly to 45% RH at 60 °C, non-condensing
Altitude	Operating	To 3,000 m (10,000 feet) Maximum operating temperature decreases 1 °C each 300 m above 1.5 km
	Non-Operating	To 12,000 m (40,000 feet)
Pollution Degree		Pollution Degree 2 (as defined in IEC 61010-1): Rated for indoor, dry location use only.

Cooling Requirements

The instrument must have adequate cooling, described in the Cooling Requirements table, for safe operation.

CAUTION: Ambient air temperature near the equipment is not necessarily inlet air temperature. Damage to the instrument can occur if this equipment is powered on without sufficient access to cool air.

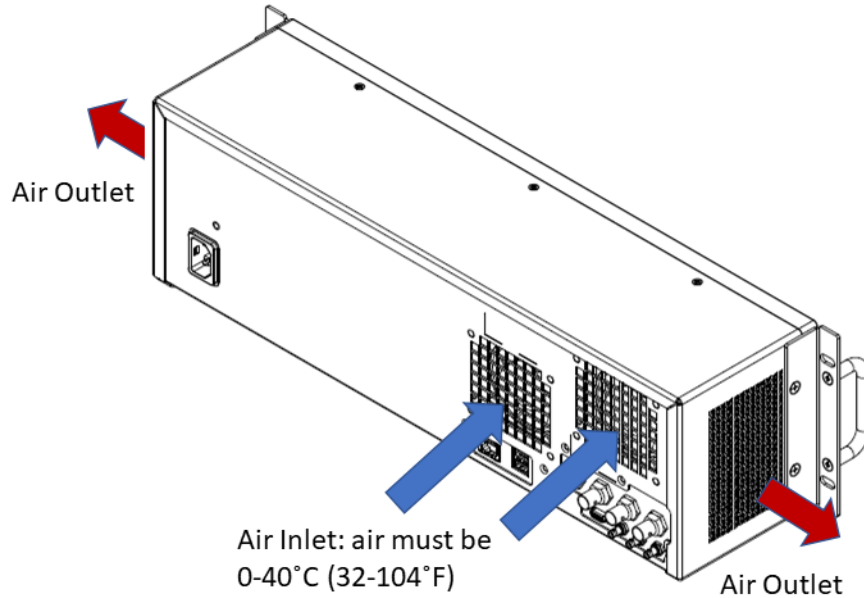

Cooling Requirements

Parameter	Location	Description
Cooling		Internal fans provide forced-air cooling. Do not block openings.
	Bare Instrument	The equipment should not be placed next to solid walls or other equipment preventing airflow. To ensure adequate air outlet, there must be at least 15 mm (0.6 inches) of clearance on both sides of the instrument. To ensure adequate air inlet, there cannot be any flat surfaces at the back of the instrument any closer than the bends in the cables connected to the instrument.
	Rackmount	Use only the included rackmount equipment to install this instrument in a rack. To ensure proper air outlet, when installing the instrument in a closed rack with solid walls there must be at least 15 mm (0.6 inches) of clearance on both sides of the instrument to the rack side walls. To ensure adequate air inlet, the surface at the back of the instrument cannot be any closer than the bends in the cables connected to the instrument.

Electrical Power Requirements

The instrument operates from an AC power input. Check that your location provides the proper electrical power requirements as listed in table MPD-100/200/300 AC Line Power Requirements

Use the proper power cord with the instrument. Table MPD-100/200/300 AC Line Power Requirements lists the power requirements for the instruments.

MPD-100/-200/-300 AC Line Power Requirements

Parameter	Description
Line voltage range	100 to 240 VAC +/- 10%
 WARNING: To reduce the risk of fire and shock, ensure that the mains supply voltage fluctuations do not exceed 10% of the operating voltage range.	
Line frequency	50/60 Hz
Line current	1.8/0.9 A
Mains Overvoltage	Overvoltage Category II (as defined in IEC 61010-1)





 **WARNING: In the instrument, only the line conductor is fused for over-current protection. The fuse is internal and not user replaceable. Do not attempt to replace the fuse. If you suspect the fuse has blown, return the unit to an authorized service center for repair.**

MPD Rack Installation

This section describes how to assemble the MPD and equipment, and install it in a rack.

Equipment

PRISM MPD Rack Parts

	Equipment	Quantity	Part number
	PRISM MPD Installation and Safety Instructions	1	P00010446x
	Short rack-ear bracket	2	P00010134x
	Handle	2	P00010331x
	Screw, truss-head, 10-32 X 0.625, Phillips Note: The example of the screw is not to scale.	4	P00010226x
	Screw, flat-head, M4 X 8, Phillips Note: The example of the screw is not to scale.	8	P00010225x

Rack Installation

This section explains how to connect the hardware to the MPD for installation in a rack.

Attach Brackets and Handles

1. Use a Phillips-head screw driver and 4 flat-head screws (M4 x 8) to connect the 2 rack-ear brackets to the MPD, one on each side.

Note: Any bracket can go on either side of an MPD.

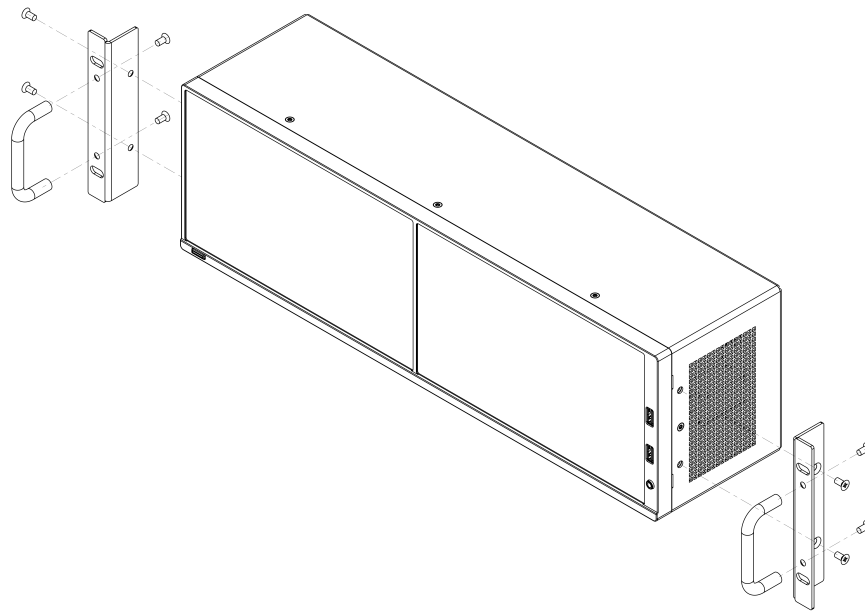

2. Use a Phillips-head screw driver and 4 flat-head screws (M4 X 8) to connect the 2 rack handles to the brackets.

Install in Rack



WARNING: To prevent injury or damage to the instrument, do not carry the PRISM by the small handles on the front of the instrument. These handles are for pulling the instrument out of a rack installation and are not intended to be used for carrying the instrument.

1. Insert the MPD assembly into the rack.
2. Use a Phillips-head screw driver and 4 truss-head screws (10-32 X 0.625) to connect the brackets of the MPD assembly to the rack.

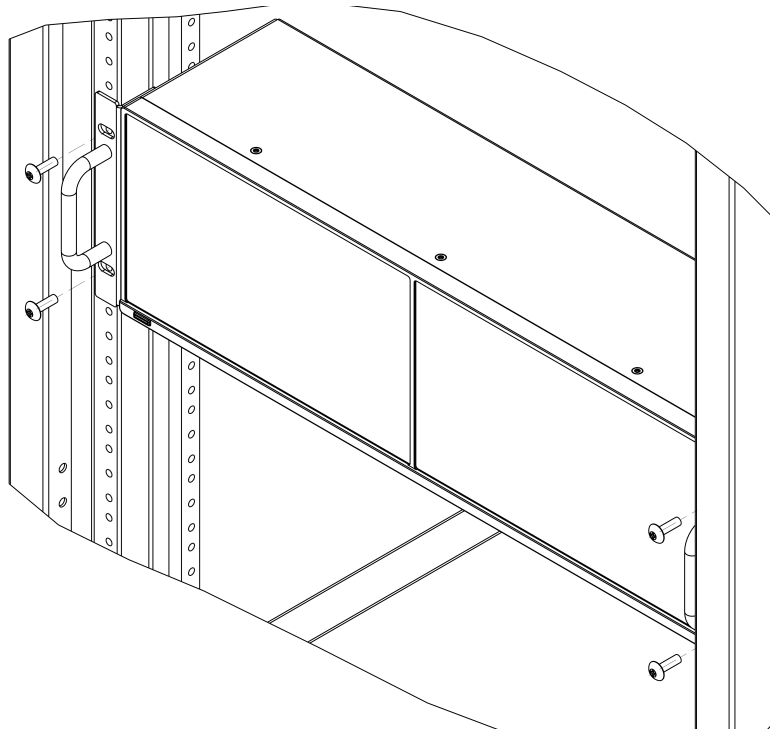

Connectors



This section shows the rear panels of the MPD models. A table with descriptions of each connector is after each example.

MPD-100

The example shows the rear panel of an MPD-100. The table provides details of each connector. For details of the front-panel connectors, see Descriptions of labeled PRISM MPD-100/-200/-300 front-panel connectors.



Descriptions of Labeled PRISM MPD-100 Rear-Panel Connectors.

Connector label, symbol, or end	Description
AC In	Connector for an AC power source.
	Ethernet port is a standard RJ-45 connector for 10/100/1000Base-T Ethernet cable.
	Two USB 3.0 ports are for connecting a mouse and keyboard, importing or exporting instrument presets, upgrading the instrument firmware, or saving screen and stream captures.
SDI1	SDI1 can operate in these modes: <ul style="list-style-type: none"> • Input only supporting SD, HD, 3G, or 12G signals • Quad Link 4K and 8K input when used in conjunction with SDI inputs 1-4 (options MPDSP-FMT-4K and MPDSP-FMT-8K)
SDI2	SDI2 can operate in these modes: <ul style="list-style-type: none"> • Input only supporting SD, HD, 3G, or 12G signals • Quad Link 4K and 8K input when used in conjunction with SDI inputs 1-4 (options MPDSP-FMT-4K and MPDSP-FMT-8K)
SDI3	SDI3 I/O can operate in these modes: <ul style="list-style-type: none"> • Input supporting SD, HD, 3G, or 12G signals • Quad Link 4K and 8K input when used in conjunction with SDI inputs 1-4 (options MPDSP-FMT-4K and MPDSP-FMT-8K) • Output loop through of SDI 1 input
SDI4	SDI4 I/O can operate in these modes: <ul style="list-style-type: none"> • Input only supporting SD, HD, 3G, or 12G signals • Quad Link 4K and 8K input when used in conjunction with SDI inputs 1-4 (options MPDSP-FMT-4K and MPDSP-FMT-8K) • Output loop through of SDI 2 input
GPIO	15-pin, mini D-sub connector, for details see MPD-100/-200/-300 remote connector pin assignments and preset functions.
REF IN	REF IN is used for analog reference signals black burst and tri-level sync for locking.

Descriptions of Labeled PRISM MPD-100 Rear-Panel Connectors.

Connector label, symbol, or end	Description
REF OUT	<p>Note: This is a dual purpose pin that can be controlled in the UI to set to REF OUT or PPS</p> <ul style="list-style-type: none"> REF OUT is a pass through of the REF IN. PPS connector outputs a 1 PPS (pulse per second) signal when the instrument is locked to a PTP reference. 3.3v drive. TTL compatible.
AUX OUT	<p>SDI output of the selected SDI, ST2022, or ST2110 input:</p> <ul style="list-style-type: none"> For Quad Link inputs (4K or 8K) the AUX OUT is link 1. ST2110-20/30 inputs are supported.

MPD-100/-200/-300 remote connector pin assignments and preset functions

Characteristic	Pin out
Connector Pin Assignments	<p>1 GND</p> <p>2 Do not connect</p> <p>3 Do not connect</p> <p>4 Do not connect</p> <p>5 Do not connect</p> <p>6 GND</p> <p>7 Do not connect</p> <p>8 Do not connect</p> <p>9 Do not connect</p> <p>10 Preset 1 (In)</p> <p>11 Preset 2 (In)</p> <p>12 Preset 3 (In)</p> <p>13 Preset 4 (In)</p> <p>14 Preset 5 (In)</p> <p>15 Preset 6 (In)</p>

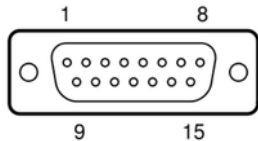



Note: The presets can be recalled through GPIO. See the PRISM MPS-MPD User Manual for details.

The example shows the front panel of an MPD-100, -200, or -300. The table provides details of each connector.



Descriptions of labeled PRISM MPD-100/-200/-300 front-panel connectors.

Connector symbol	Description
	2 USB 3.0 ports are for connecting a mouse and keyboard, importing or exporting instrument presets, upgrading the instrument firmware, or saving screen and stream captures.
	Audio output (1/8-inch—3.5 mm—line out) port is for headphones to listen to the selected audio channel pair. ¹



1. Audio output is a 1/8-inch (3.5 mm) diameter port for a headset. It has connections for left and right audio channels. Headset plugs that are 1/8 inch and have an additional contact for a microphone may not work because the headphone ports are not set for the spacing requirements of a third connection on the plug.

MPD-200/-300

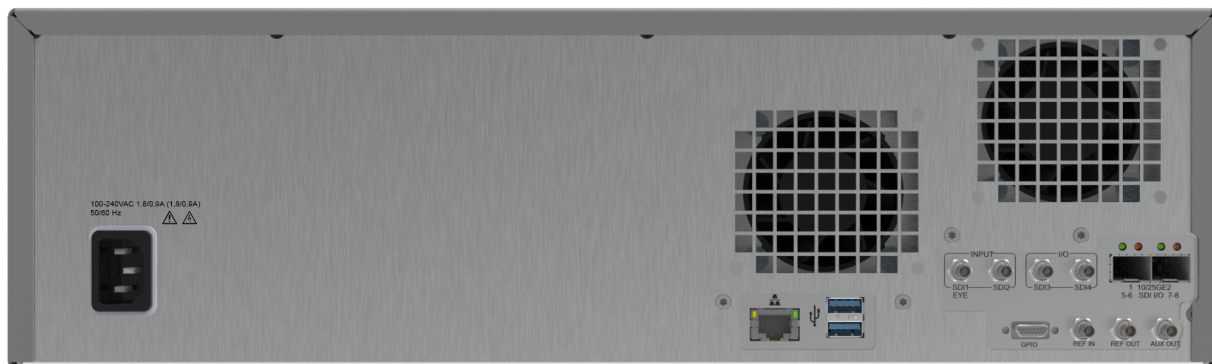
The example shows the rear panel of an MPD-300. The table provides details of each connector. For details of the front-panel connectors, see Descriptions of labeled PRISM MPD-100/-200/-300 front-panel connectors.



Descriptions of labeled PRISM MPD-300 rear-panel connectors.

Connector label or symbol	Description
AC In	Connector for an AC power source.
	Ethernet port is a standard RJ-45 connector for 10/100/1000Base-T Ethernet cable.
	Two USB 3.0 ports are for connecting a mouse and keyboard, importing or exporting instrument presets, upgrading the instrument firmware, or saving screen and stream captures.
SDI1 (EYE in 300 only)	SDI 1 can operate in these modes: <ul style="list-style-type: none"> • Input only supporting SD, HD, 3G, or 12G signals. • Quad Link 4K and 8K input when used in conjunction with SDI inputs 1-4 (options MPDSP-FMT-4K and MPDSP-FMT-8K) • MPD-300 only: Eye diagram up to 12G for physical layer measurements, including automated measurements of 12G SDI eye pattern parameters (option MPDSP-PHY).
SDI2	SDI2 can operate in these modes: <ul style="list-style-type: none"> • Input only supporting SD, HD, 3G, or 12G signals • Quad Link 4K and 8K input when used in conjunction with SDI inputs 1-4 (options MPDSP-FMT-4K and MPDSP-FMT-8K)
SDI3	SDI3 I/O can operate in these modes: <ul style="list-style-type: none"> • Input supporting SD, HD, 3G, or 12G signals • Quad Link 4K and 8K input when used in conjunction with SDI inputs 1-4 (options MPDSP-FMT-4K and MPDSP-FMT-8K) • Output loop through of SDI 1 input
SDI4	SDI4 I/O can operate in these modes: <ul style="list-style-type: none"> • Input only supporting SD, HD, 3G, or 12G signals • Quad Link 4K and 8K input when used in conjunction with SDI inputs 1-4 (options MPDSP-FMT-4K and MPDSP-FMT-8K) • Output loop through of SDI 2 input
10/25GE SDI I/O	SFP module slots can be configured for IP or SDI applications. <ul style="list-style-type: none"> • 10/25GE: Two optional SFP+ ports are for 10/25GE Ethernet applications. See MP-SFP products for available modules. • SDI I/O (this configuration is for future functionality): Two optional SFP+ ports can provide up to four SDI signal loop-through outputs, up to 12G for future functionality.
GPIO	15-pin, mini D-sub connector. For details see MPD-100/-200/-300 remote connector pin assignments and preset functions.

Descriptions of labeled PRISM MPD-300 rear-panel connectors.

Connector label or symbol	Description
REF IN	REF IN is used for analog reference signals black burst and tri-level sync for locking
REF OUT	<p>Note: This is a dual purpose pin that can be controlled in the UI to set to REF OUT or PPS</p> <ul style="list-style-type: none"> REF OUT is a pass through of the REF IN. PPS connector outputs a 1 PPS (pulse per second) signal when the instrument is locked to a PTP reference. 3.3v drive. TTL compatible.
AUX OUT	<p>SDI output of the selected SDI, ST2022, or ST2110 input:</p> <ul style="list-style-type: none"> For Quad Link inputs (4K or 8K) the AUX OUT is link 1. ST2110-20/30 inputs are supported.

SFP Module

There are several types of optional SFP modules available for the MPD-200 and -300 products.

SFP Module Installation and Removal

1. Remove the plug from the SFP connector.
2. Insert the SFP module into the SFP connector. The module will latch into place when fully inserted.

Note: There are different types of SFP modules with different latching mechanisms.

To remove the optical SFP module, lift up on the latch and then pull the module out of the SFP connector.

SFP Module Transportation

 **CAUTION:** To prevent static damage to the SFP module, if you remove the SFP module from the instrument, always store and transport the SFP module in an anti-static bag or container.

 **CAUTION:** To prevent possible damage to the PRISM monitor and SFP modules, remove the SFP modules before transporting the PRISM monitor.

Operation

This section describes the basic operations and uses of the unit. For a detailed explanation, consult the user manual.

Power-on and Power-off Procedures

This describes how to apply power to the instrument and how to power-on and power-off the instrument.

Power Cord Installation

This instrument is powered by an AC power source. Connect the power cord to the power connector on the rear panel of the instrument. The power connector is keyed to be directional, with the flat portion of the power cord housing facing the left of the instrument (as viewed from the rear). When fully inserted, the power cord housing latches onto the instrument power connector.



CAUTION: To minimize the risk of damage to the instrument, we strongly recommend the power cord be connected to the instrument before the power cord is connected to the AC power source.

Power-on Procedure

1. Apply power to the instrument.

Note: If the PRISM was previously powered off by a power interruption or by removing the power cord from the rear of the instrument, the instrument powers on when power is reapplied.

2. Press the power button on the instrument front panel to turn the instrument on.

Note: The power button lights during the power-on sequence and then turns off during normal instrument operation.

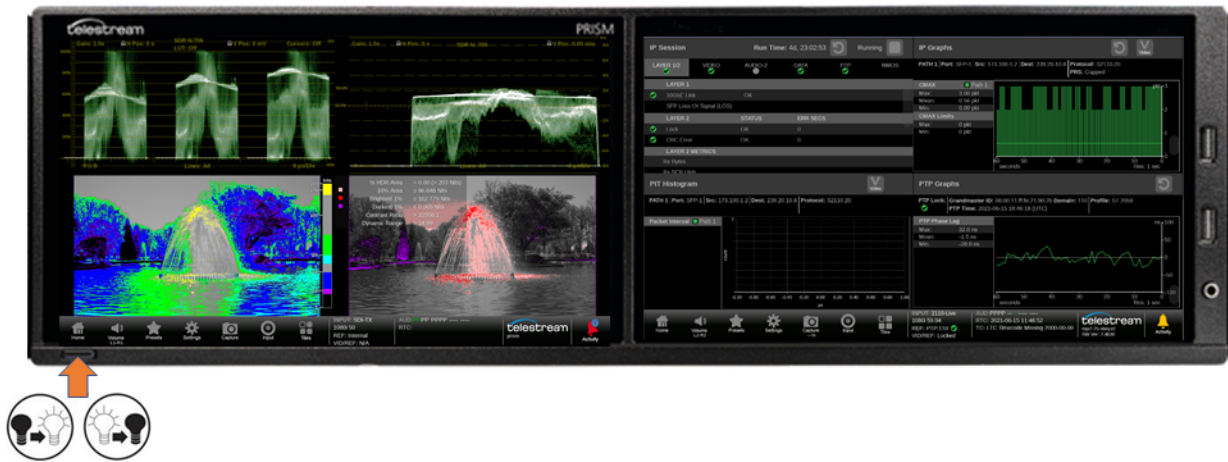

Power-off Procedure

1. Press the power button to turn the instrument off.







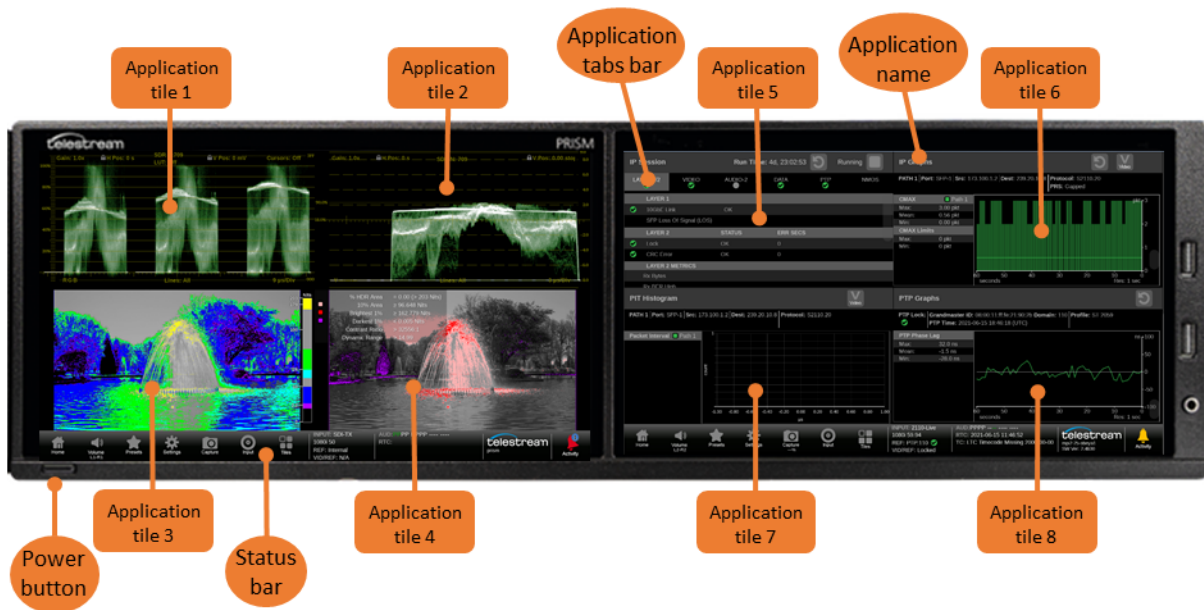

CAUTION: To prevent data loss, we strongly recommend you first shut down the instrument before disconnecting the power cord. Press the power button or select Settings, Utilities, Power, and then Power Down Now.

2. To completely remove power from the instrument, disconnect the power cord from the instrument. The power cord has a locking mechanism to keep it attached to the instrument. Push the button on the cord housing to release the locking mechanism.

Display Elements



Descriptions of PRISM MPD front panel elements

Item name	Description
Application tiles 1-8	Location of the application tile ¹
Power button	Press the button to turn the instrument on or off. To completely remove power from the instrument, remove the power cord.
	CAUTION: To prevent data loss, we strongly recommend you first shut down the instrument before disconnecting the power cord. Press the power button or select Settings, Utilities, Power, and then Power Down Now.
Status bar	<p>The left side of the Status bar has icons with links to various instrument settings including volume () , presets () , global settings () , input type () , and the tile application menu () . Select the Home icon () to exit any displayed menus.</p> <p>The right side of the status bar lists instrument status such as the selected input, type of input signal, selected signal reference, video/reference signal status, audio channel status, the real time clock setting, and a link to the Activity menu () .</p>
Application tabs	Some applications have selectable tabs (highlighted readouts) you can use to display additional information.

Descriptions of PRISM MPD front panel elements

Item name	Description
Application name:	Lists the name of the displayed application.

1. The application tiles can be in quarter-screen display, half-screen display, or one application in full-screen display.

Methods of Operation

This section describes the primary methods of operating the instrument:

- Keyboard and Mouse
- Touchscreen Display
- External Touchscreen Display
- Remote Control through VNC
- Remote Control through API or NMOS

Keyboard and Mouse

You can use a USB keyboard and mouse to operate the instrument. The mouse needs to have a scrolling wheel to access all of the menu selections. Click on applications to perform actions like you would on the touch panel.

Connect the keyboard, mouse, and external display:

- Connect the keyboard and mouse to any of the available USB ports.
- Use the USB ports on the front of the MPD.

Touchscreen Display

The example of the application menu, which has all the available applications, is open in front of 4 tiled applications. The application menu changes depending on the options purchased.



Supported Touchscreen Gestures

You can use the instrument front panel to perform the functions:

- Touch or tap the screen to select display elements.
- Double tap an application banner to toggle the display between four-tile and a full-screen display of the selected application.
- Swipe up or down, or left or right as necessary to navigate menus and preset listings and to view additional application information.
- Some applications support pinch and zoom.
- Recall instrument presets.
- Control or mute the volume on the headphone outputs.
- Connect a USB drive to import or export instrument presets, upgrade the instrument firmware, or save screen and stream captures.

Note: The terms “tap,” “swipe,” and “pinch” apply to the touchscreen on the instrument. If you are using a mouse and keyboard you must “click,” “scroll,” and use the scroll wheel on the mouse.



External Touchscreen Display

You can use an external touchscreen display to control the instrument. Two connections are required:



- Connect the Display Port output from the PRISM to the input on the external device.
- Connect the output of the external device to one of the USB ports on the PRISM.

Note: The instrument works best with a 1920×1080-capable monitor.

You can select applications from the Application menu or from the All Applications menu. You can set what applications appear on the Application menu.

1. Select the Application menu icon () to open the application tool bar.
2. Select an application from the application tool bar to open the application.
3. If an application is not available on the application tool bar, select the All Applications icon () at the right of the application tool bar, to open the application menu, which shows all available applications, and select the application.

4. In the application menu, select **Edit** to change the applications available in the application tool bar. Up to 8 applications can be listed on the application tool bar. The number notes the location of the application on the application tool bar.
 - Click an application marked with a number to remove it from the application tool bar.
 - Click an application that is not marked with a number to add it to an empty space in the application tool bar.
 - Select the application in a tile and then select the icon in the application tool bar to open the settings menu for the application.
5. Double select, in an application to change the application display to full screen. Double select a full screen application to return it to its previous size.
6. Select the half-screen icon () in the menu bar to change the selected application display to vertical extended mode.

The vertical extended mode is useful for when you want to view two application displays side-by-side. When an application display is in vertical extended mode, select the collapse icon () in the menu bar to return to quarter tile mode.
7. If available, select the reset icon () to clear or reset the selected display.

Remote Control through VNC Operation

When the PRISM is connected to an Ethernet network, you can use a computer connected to the same network to remotely control the instrument in a web browser or in a VNC client, such as VNC Viewer. Connect to the PRISM by using VNC:

VNC Client

When using VNC for extended periods of time, we recommend using a VNC client:

1. On the PRISM to connect to, select **Settings** and then select **Network**.
2. Find the Control IP Port IP address of the instrument.
3. On your computer, open your VNC client and enter the IP address of the Control IP Port of the instrument in the VNC Server search bar.

Note: A unique PRISM Hostname can be used instead of the IP address. To set a Hostname, select **Settings** and then select **Network**, and select the **Web Remote** tab.

The VNC client connects to the instrument in a separate window that appears exactly like the instrument display.

Web Browser

To connect to the instrument through a web browser:

1. On the PRISM to connect to, select **Settings**, then select **Network**, and find the Control IP Port IP address of the instrument.

2. In a web browser, enter the address

<http://xxx.xxx.xxx.xxx:6080/vnc.html>

where xxx.xxx.xxx.xxx is the IP address of the Control IP Port of the instrument.

Note: If you have set a unique Hostname for the instrument, enter it in the browser address bar and select the **noVNC Access** link.

This opens a login web page.

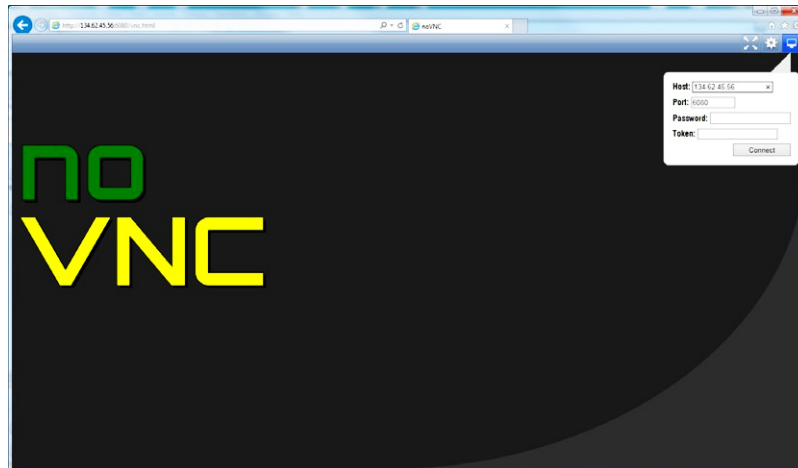

3. In the Control bar, click the Settings icon (⚙️) to open the Settings menu.

4. In the Settings menu, open the **Scaling Mode** drop-down list to select **Local Scaling**, and then click **Apply**.

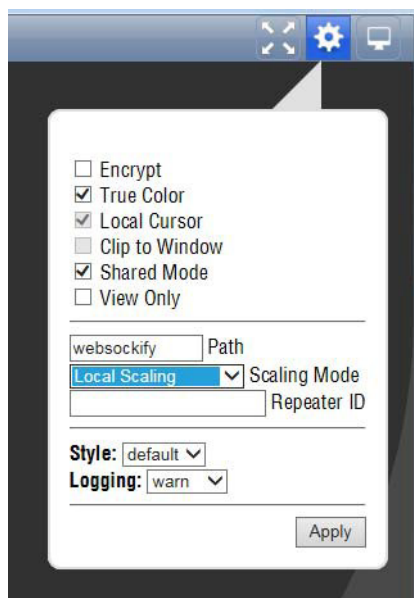

5. In the Control bar, click the **Connect** icon () to open the Connect menu.

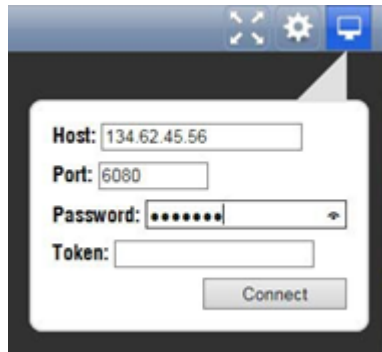

6. In the Connect menu, enter the default password **PRISM**, and then click **Connect**.

Note: A unique PRISM hostname can be used instead of the IP address. To set a hostname, select **Settings**, then select **Network**, and select the **Web Remote** tab.

The web browser connects to the instrument with the browser display appearing exactly like the display on the monitor.

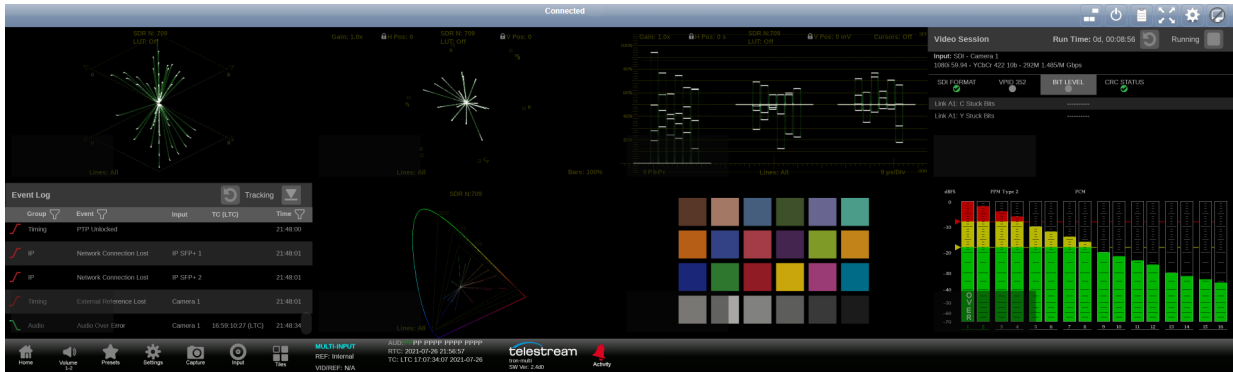

Remote Control through API or NMOS

The PRISM can be controlled through API commands over the network, or as an NMOS client. Although API or NMOS operation does not allow you to fully interact with the instrument, they are useful for making changes in a production automation environment.

The available API commands can be displayed in the PRISM Home page:

1. Open a web browser and enter the IP address of the instrument.
2. Select **API Help Page** to view all available API commands.

API commands use HTML GET/POST methods.