

**WFM4000 and WFM5000
Waveform Monitors
WVR4000 and WVR5000
Waveform Rasterizers
System Integration Technical Reference**



077-2506-01

**WFM4000 and WFM5000
Waveform Monitors
WVR4000 and WVR5000
Waveform Rasterizers
System Integration Technical Reference**

Warning

The service instructions are for use by qualified personnel only. To avoid personal injury, do not perform any servicing unless you are qualified to do so. Refer to all safety summaries prior to performing service.

www.tektronix.com

077-2506-01

Tektronix

Copyright © Tektronix. All rights reserved. Licensed software products are owned by Tektronix or its subsidiaries or suppliers, and are protected by national copyright laws and international treaty provisions.

Tektronix products are covered by U.S. and foreign patents, issued and pending. Information in this publication supersedes that in all previously published material. Specifications and price change privileges reserved.

TEKTRONIX and TEK are registered trademarks of Tektronix, Inc.

Contacting Tektronix

Tektronix, Inc.
14200 SW Karl Braun Drive
P.O. Box 500
Beaverton, OR 97077
USA

For product information, sales, service, and technical support:

- In North America, call 1-800-833-9200.
- Worldwide, visit www.tektronix.com to find contacts in your area.

Table of Contents

General Safety Summary	ii
Service Safety Summary	iv
Environmental Considerations	v
Preface	vii
Related User Documents	vii
Related Reference Documents	ix
System Integration	1
Installation Considerations	3
WFM4000 and WFM5000 Power and Environmental Specifications	4
WVR4000 and WVR5000 Power and Environmental Specifications	6
Connector Specifications	7
WFM4000 and WFM5000 Rackmount Installation	12
Installing a WFM4000 or WFM5000 into the Rack Adapter	18
Network Operation for the WFM and WVR	21

General Safety Summary

Review the following safety precautions to avoid injury and prevent damage to this product or any products connected to it.

To avoid potential hazards, use this product only as specified.

Only qualified personnel should perform service procedures.

To Avoid Fire or Personal Injury

Use Proper Power Cord. Use only the power cord specified for this product and certified for the country of use.

Ground the Product. This product is grounded through the grounding conductor of the power cord. To avoid electric shock, the grounding conductor must be connected to earth ground. Before making connections to the input or output terminals of the product, ensure that the product is properly grounded.

Observe All Terminal Ratings. To avoid fire or shock hazard, observe all ratings and markings on the product. Consult the product manual for further ratings information before making connections to the product.

Do not apply a potential to any terminal, including the common terminal, that exceeds the maximum rating of that terminal.

Power Disconnect. The power cord disconnects the product from the power source. Do not block the power cord; it must remain accessible to the user at all times.

Do Not Operate Without Covers. Do not operate this product with covers or panels removed.

Do Not Operate With Suspected Failures. If you suspect that there is damage to this product, have it inspected by qualified service personnel.

Avoid Exposed Circuitry. Do not touch exposed connections and components when power is present.

Replace Batteries Properly. Replace batteries only with the specified type and rating.

Recharge Batteries Properly. Recharge batteries for the recommended charge cycle only.

Use Proper AC Adapter. Use only the AC adapter specified for this product.

Do Not Operate in Wet/Damp Conditions.

Do Not Operate in an Explosive Atmosphere.

Keep Product Surfaces Clean and Dry.

Provide Proper Ventilation. Refer to the manual's installation instructions for details on installing the product so it has proper ventilation.

Terms in this Manual These terms may appear in this manual:



WARNING. *Warning statements identify conditions or practices that could result in injury or loss of life.*



CAUTION. *Caution statements identify conditions or practices that could result in damage to this product or other property.*

Symbols and Terms on the Product

These terms may appear on the product:

- DANGER indicates an injury hazard immediately accessible as you read the marking.
- WARNING indicates an injury hazard not immediately accessible as you read the marking.
- CAUTION indicates a hazard to property including the product.

The following symbol(s) may appear on the product:



CAUTION
Refer to Manual

Service Safety Summary

Only qualified personnel should perform service procedures. Read this *Service Safety Summary* and the *General Safety Summary* before performing any service procedures.

Do Not Service Alone. Do not perform internal service or adjustments of this product unless another person capable of rendering first aid and resuscitation is present.

Disconnect Power. To avoid electric shock, switch off the instrument power, then disconnect the power cord from the mains power.

Use Care When Servicing With Power On. Dangerous voltages or currents may exist in this product. Disconnect power, remove battery (if applicable), and disconnect test leads before removing protective panels, soldering, or replacing components.

To avoid electric shock, do not touch exposed connections.

Environmental Considerations

This section provides information about the environmental impact of the product.

Product End-of-Life Handling

Observe the following guidelines when recycling an instrument or component:

Equipment Recycling. Production of this equipment required the extraction and use of natural resources. The equipment may contain substances that could be harmful to the environment or human health if improperly handled at the product's end of life. In order to avoid release of such substances into the environment and to reduce the use of natural resources, we encourage you to recycle this product in an appropriate system that will ensure that most of the materials are reused or recycled appropriately.



This symbol indicates that this product complies with the European Union's requirements according to Directive 2002/96/EC on waste electrical and electronic equipment (WEEE). For information about recycling options, check the Support/Service section of the Tektronix Web site (www.tektronix.com).

Perchlorate Materials. This product contains one or more type CR lithium coin cell batteries. According to the state of California, CR lithium coin cells are classified as perchlorate materials and require special handling. See www.dtsc.ca.gov/hazardouswaste/perchlorate for additional information.

Restriction of Hazardous Substances

This product has been classified as Monitoring and Control equipment, and is outside the scope of the 2002/95/EC RoHS Directive.

Preface

This document is provided as an aid for system integrators who are designing systems for high-definition (HD) and standard-definition (SD) digital video content where the Tektronix WFM4000 and WFM5000 Waveform Monitors or the WVR4000 and WVR5000 Waveform Rasterizers are to be deployed.

Tektronix provides many products designed to test, measure, and monitor analog and digital video/audio signals. These products include waveform monitors, audio monitors, signal generators, and video measurement sets. For MPEG video signals, Tektronix also provides test systems, transport stream monitors, players/recorders, and portable analyzers.

Related User Documents

The following tables list related user documents for the products discussed in this document. These tables also indicate whether the document is printed, and whether the PDF of the document is available only on the Tektronix Web site (www.tektronix.com) or also on the Product Documentation CD that accompanies the printed Quick Start Guide Reference.

Table i: WFM related user documents

Document	Tektronix part number	Description	Availability		
			Print	Web	CD
Quick Start Guide Reference kit	020-2918-XX	Contains basic turn on and navigation information provided in printed, graphical format. This document comes with a Product Documentation CD that contains PDFs of other user documents.	✓	✓	
User Manual	071-2438-XX (English) 071-2440-XX (Japanese) 071-2441-XX (Simplified Chinese)	These documents contain operating information for the instrument. They are available on the Web and on the Product Documentation CD.	✓	✓	✓
Release Notes	061-2444-XX	Describes any known problems or behaviors that you might encounter while using the instrument.		✓	
Specifications and Performance Verification Technical Reference	077-2439-XX	Contains the complete published specifications for the instrument and the performance verification procedures.		✓	✓

Table i: WFM related user documents (cont.)

Document	Tektronix part number	Description	Availability		
			Print	Web	CD
Service Manual	077-2442-XX	Provides servicing information for the instrument and is intended only for qualified service personnel.	✓	✓	
Declassification and Security Instructions	071-2443-XX	Provides declassification and security procedures for users needing information on eliminating and/or securing instrument memory.		✓	✓

Table ii: WVR related user documents

Document	Tektronix part number	Description	Availability		
			Print	Web	CD
Quick Start Guide Reference kit	020-2917-XX	Contains basic turn on and navigation information provided in printed, graphical format. This document comes with a Product Documentation CD that contains PDFs of other user documents.	✓	✓	
User Manual	077-2445-XX (English) 077-2446-XX (Japanese) 077-2447-XX (Simplified Chinese)	These documents contain operating information for the instrument. They are available on the Web and on the Product Documentation CD.	✓	✓	✓
Release Notes	061-2451-XX	Describes any known problems or behaviors that you might encounter while using the instrument.		✓	
Specifications and Performance Verification Technical Reference	077-2448-XX	Contains the complete published specifications for the instrument and the performance verification procedures.		✓	✓
Service Manual	077-2449-XX	Provides servicing information for the instrument and is intended only for qualified service personnel.	✓	✓	
Declassification and Security Instructions	071-2450-XX	Provides declassification and security procedures for users needing information on eliminating and/or securing instrument memory.		✓	✓

Related Reference Documents

The following table lists related reference documents. The table also indicates whether the PDF of the document is available only on the Tektronix Web site (www.tektronix.com) or also on the Product Documentation CD that accompanies the printed Quick Start Guide Reference.

Table iii: Related reference documents

Document	Description	Availability	
		Web	CD
Preventing Illegal Colors	This application note describes how the Diamond, Arrowhead, and Lightning displays can be used to help prevent the undesired impact of color gamut violations and to simplify the assessment of proper gamut compliance.	✓	
Video Glossary	This glossary defines common video terms.	✓	✓
Understanding Colors and Gamut	This poster provides a large visual display of how the Diamond, Arrowhead, and Lightning displays can be used to help prevent the undesired impact of color gamut violations.	✓	
A Guide to Standard and High Definition Digital Video Measurements	This book is a primer for understanding the basics for making standard and high-definition, digital-video measurements.	✓	
Analog and Digital Audio Monitoring	This application note describes how to monitor analog and digital audio signals. Also discussed are specific differences in the methods used to monitor analog audio versus digital audio, and how to plan the transition from monitoring analog audio to monitoring digital audio.	✓	
Audio Monitoring	This application note describes balanced and unbalanced audio signals, and explains the physical and electrical characteristics and the specific strength and weaknesses of the different digital audio signal formats.	✓	
NTSC Video Measurements	This book is a primer for understanding the basics for making NTSC video measurements.	✓	
PAL Systems Television Measurements	This book is a primer for understanding the basics for making PAL video measurements.	✓	✓

System Integration

The following illustrations show the front panel and rear panel of the WFM and WVR products.

NOTE. You can locate copies of some of the illustrations from this document on the Tektronix Web site (www.tektronix.com) and on the Product Documentation CD.

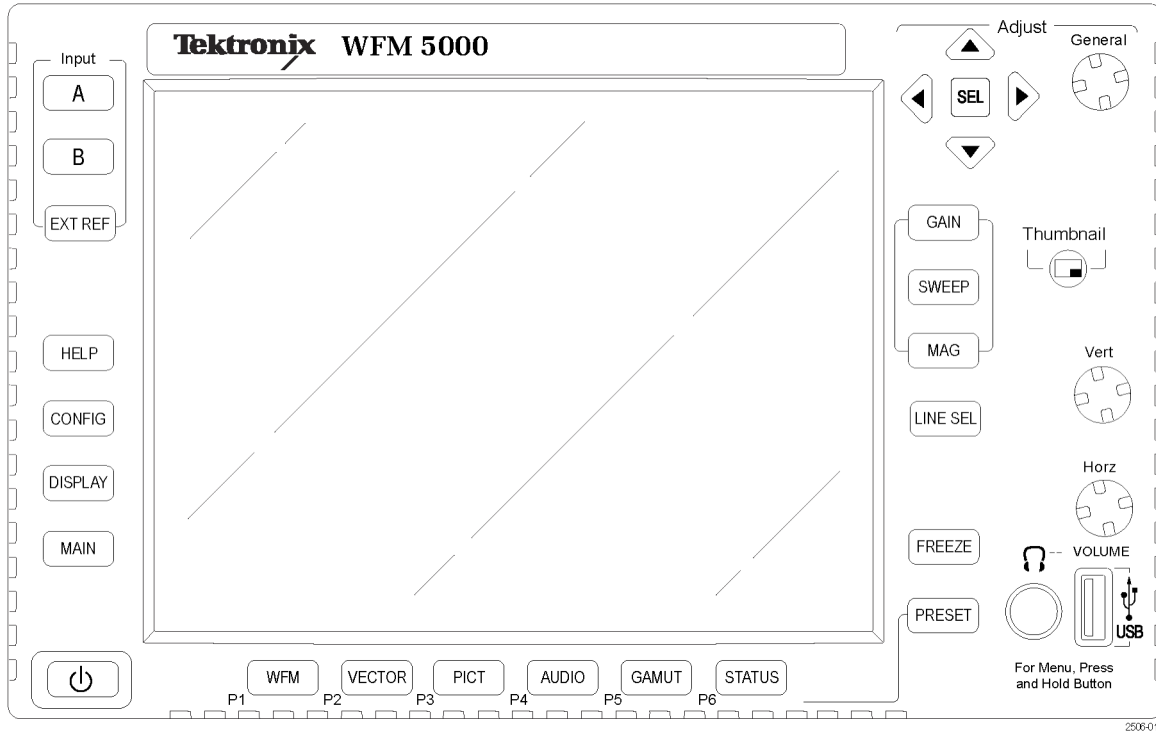

Figure 1: WFM front panel

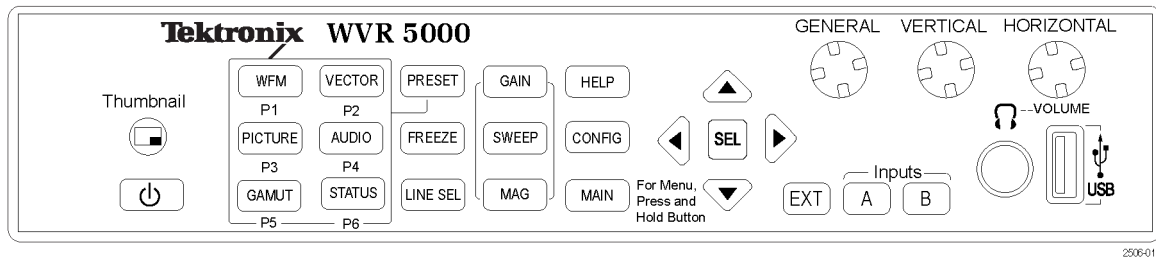
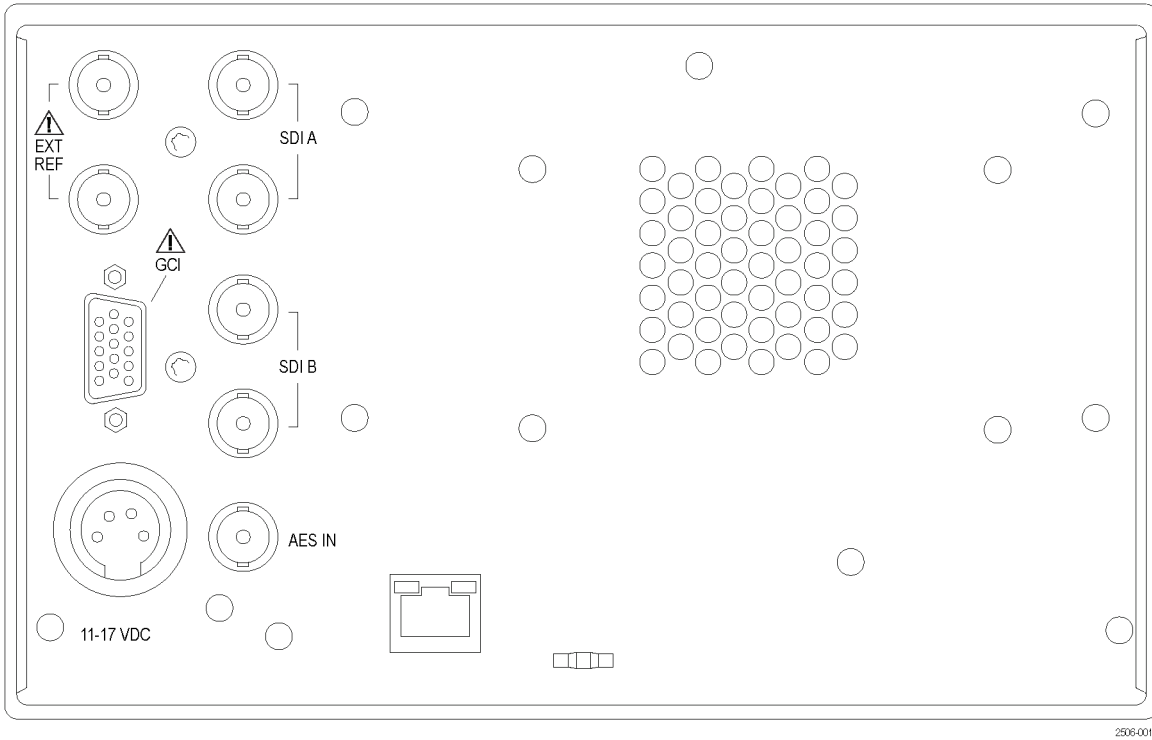
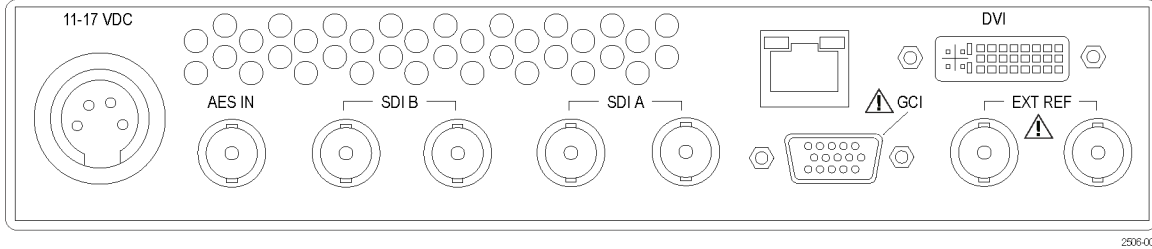

Figure 2: WVR front panel



2506-001

Figure 3: WFM rear panel



2506-006

Figure 4: WVR rear panel

Installation Considerations

To install your instrument in an approved portable cabinet or rack adapter, mounting instructions are provided in this document.

For the WFM products, a soft carrying case and a hard case are available for purchase as optional accessories. To install your instrument in a carrying case, follow any instructions that are included with that optional accessory kit.

The WVR products fit in a 19 inch rack, 1 RU high, and come with rack slides installed on the chassis.

You can also install these instruments in a custom installation, such as a console.



CAUTION. *To prevent damage to the instrument and the cabinet, do not install these products in any cabinet except one provided with your instrument or by Tektronix.*

If you install the instrument in a custom application, such as a console, be sure to provide adequate airflow. Follow these guidelines:

- Do not block the ventilating holes.
- Adhere to the clearance requirements. (See Table 1 on page 5.)

System Installation

This instrument can operate almost anywhere in the video distribution system. To monitor the video bitstream of a serial receiver, route the incoming serial signal into one of the SDI inputs of the instrument.

To monitor serial digital signals around a routing switcher, connect your serial sources through a patch panel to a serial router. Connect the output of the serial router to an SDI input for comparison.

Line Termination

This instrument uses passive loop-through analog and reference inputs. Accordingly, the loopthrough inputs must be terminated externally. It is important that this external termination meets accuracy and return loss requirements. Terminations for loop-throughs on SDI or reference connectors in end-of-link setups must be 75 Ω and DC coupled (good return loss extends to DC). An appropriate termination would be a 75 Ω End of Line terminator, Tektronix part number 011-0163-XX.

If the instrument is installed to monitor an operating link, the destination receiver and the connecting cable serve as the termination. This monitoring connection checks the performance of the entire path. The return loss of the instrument is sufficiently high that, in most cases, the destination receiver sets the system return loss.

Compatibility of BNC Center Pins

Most video equipment BNC connectors, whether 50 Ω or 75 Ω , use a 50 Ω standard center pin. Some laboratory 75 Ω BNC connectors use a smaller diameter center pin. The BNC connectors on this instrument are designed to work with the 50 Ω standard (large diameter) center pins.



CAUTION. *To prevent intermittent signal connections, do not use connectors or terminators with the smaller diameter center pins.*

WFM4000 and WFM5000 Power and Environmental Specifications

These instruments operate from an AC line frequency of 50 or 60 Hz, over the range of 100-240 Volts, without the need for configuration, except the power cord. For a list of available power cords, see the *User Manual* included with your product on the *Product Documentation CD*. The typical power draw is 22 Watts for the WFM products.

NOTE. *Power systems with both current-carrying conductors live with respect to ground (such as phase-to-phase in multiphase systems) are not recommended as power sources.*

These instruments can be powered by a 12 V DC input or by a 14.4 V standard camera battery. If you are using a battery with this instrument, read the battery safety notices in the *User Manual* included on the *Product Documentation CD*.

The following table lists the power and environmental specifications for installing the WFM4000 and WFM5000 instruments. Refer to the *Specifications and Performance Verification* document on the *Product Documentation CD* for additional information on power and environmental requirements.

Table 1: WFM4000 and WFM5000 power and environmental specifications

Characteristic	Description	
Power	Input Voltage	100 to 240 VAC \pm 10%
	Input Power Frequency	50/60 Hz
	Power Consumption, typical	22 Watts at 110 or 240 VAC
Temperature	Operating	0 °C to +40 °C
	Non-operating	-20 °C to +60 °C
Humidity	Operating	20% to 80% relative humidity (% RH) at up to +40 °C, non-condensing
	Non Operating	5% to 90% RH (relative humidity) at up to +60 °C, non-condensing
Altitude	Operating	3,000 m (9,842 ft)
	Non-operating	12,192 m (40,000 ft)
Dimensions	Height	132.1 mm (5.2 in)
	Width	213.4 mm (8.4 in)
	Depth (including BNCs and knobs)	139.7 mm (5.5 in)
Weight	Net	1.56 kg (3 pounds 7 ounces)
	Shipping	4.08 kg (9 pounds), approximate
Required Clearances	Top	None
	Bottom	None
	Left side	2 in (51 mm)
	Right side	2 in (51 mm)
	Front	None
	Rear	2 in (51 mm)

WVR4000 and WVR5000 Power and Environmental Specifications

These instruments operate from an AC line frequency of 50 or 60 Hz, over the range of 100-240 Volts, without the need for configuration, except the power cord. For a list of available power cords, see the *User Manual* included with your product on the *Product Documentation CD*. The typical power draw is 17 Watts for the WVR products.

NOTE. *Power systems with both current-carrying conductors live with respect to ground (such as phase-to-phase in multiphase systems) are not recommended as power sources.*

The following table lists the power and environmental specifications for installing the WVR4000 and WVR5000 instruments. Refer to the *Specifications and Performance Verification* document on the *Product Documentation CD* for additional information on power and environmental requirements.

Table 2: WVR4000 and WVR5000 power and environmental specifications





Characteristic	Description	
Power	Input Voltage	100 to 240 VAC \pm 10%
	Input Power Frequency	50/60 Hz
	Power Consumption, typical	17 Watts at 110 or 240 VAC
Temperature	Operating	0 °C to +40 °C
	Non-operating	-20 °C to +60 °C
Humidity	Operating	20% to 80% relative humidity (% RH) at up to +40 °C, non-condensing
	Non Operating	5% to 90% RH (relative humidity) at up to +60 °C, non-condensing
Altitude	Operating	3,000 m (9,842 ft)
	Non-operating	12,192 m (40,000 ft)
Dimensions	Height	43.2 mm (1.7 in)
	Width	206.0 mm (8.1 in)
	Depth (including BNCs and knobs)	457.2 mm (18.1 in)
Weight	Net	1.7 kg (3 pounds 12 ounces)
	Shipping	3.63 kg (8 lbs), approximate
Required Clearances	Top	None
	Bottom	None
	Left side	None
	Right side	None
	Front	None
	Rear	152.4 mm (6 in)

Connector Specifications

The WFM and WVR instruments have connectors on the front and rear panels. The following pages describe the connector types, pin numbering, and associated signal requirements.

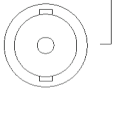
SDI Video Connectors Use the SDI A and SDI B inputs to connect a serial digital video signal to the instrument.

Table 3: SDI video connector specifications

Connector	Characteristic	Description
 <p>SDI A</p>	Input Type	BNC, passive loop-through, 75 Ω compensated
 <p>SDI B</p>		
 <p>SDI B</p>		
 <p>SDI B</p> <p>WFM4000, WFM5000</p>		
 <p>SDI B SDI A</p> <p>WVR4000, WVR5000</p>		
	Input Level	800 mV ± 10%
	Cable Loss Accommodation: SD	0 to 30 dB attenuation Equivalent to approximately 300 m of Belden 8281 at 270 Mb/s With 1/SQRT(f) characteristic at 1/2 of serial rate
	Cable Loss Accommodation: HD	0 to 20 dB attenuation Equivalent to approximately 80 m of Belden 8281 at 1.485 Gb/s Typical performance to 110 m

Video External Reference Connector

Use the EXT REF connector to input a tri-level sync signal for use as a sync timing reference for the selected video input signal. The following table lists the signal characteristics of the external reference connectors.

Table 4: External reference connector specifications

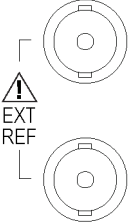
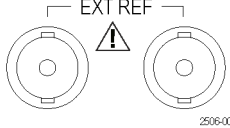

Connector	Characteristic	Description
 <p>WFM4000, WFM5000</p>	Input Type	BNC, passive loop-through, 75 Ω compensated
	Input Level	-6 to +6 dB
	Maximum Input Voltage Level	± 5 V, DC
	Maximum Absolute Input Voltage	± 5 V, DC
 <p>WVR4000, WVR5000</p>		

AES Digital Audio Connectors

Use the AES IN audio connector to input digital audio signals. Use the Digital Audio Settings menu to configure the channel mapping in the audio display.

The following table lists the signal characteristics of the AES IN connector.

Table 5: AES digital audio connector specifications

Connector	Characteristic	Description
 <p>AES IN 2506-004 WFM4000, WFM5000</p>	Input Type	BNC, 75 Ω terminated, unbalanced (meets requirements of AES 3-ID and SMPTE 276M-1995)
 <p>AES IN 2506-009 WVR4000, WVR5000</p>	Input Amplitude Range	0.1 V _{p-p} to 2 V _{p-p}

Ground Closure Interface

The ground closure interface (GCI) connector uses ground closures for presets and to indicate to external equipment that alarms have occurred. The input of LTC is through the GCI connector. The GCI connector is a 15-pin D-type connector with socket contacts. The following table lists the signal characteristics of the GCI connector.

Table 6: Remote connector pin assignments and specifications

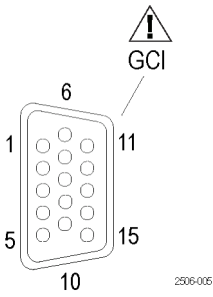
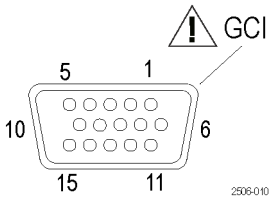
Characteristic	Performance requirement	Reference information			
		Hex	Binary Pins 15, 14, 13, 12, 11, 10	Direct mode selection	Encoded mode selection
 <p>WFM4000, WFM5000</p>  <p>WVR4000, WVR5000</p>	1 GND (In)	F	111111	none	No action
	2 Reserved (I/O)	E	XX1110	Preset 1	No action
	3 Reserved (I/O)	D	XX1101	Preset 2	No action
	4 Reserved (In)	C	XX1100		SDI B
	5 Reserved (In)	B	XX1011	Preset 3	SDI A
	6 GND (In)	A	XX1010		No action
	7 Time Code Positive (LTC In)	9	XX1001		No action
	8 Time Code Negative (LTC In)	8	XX1000		Preset 8
	9 Ground Closure (Alarm Out)	7	XX0111	Preset 4	Preset 7
	10 Preset 1 (In)	6	XX0110		Preset 6
	11 Preset 2 (In)	5	XX0101		Preset 5
	12 Preset 3 (In)	4	XX0100		Preset 4
	13 Preset 4 (In)	3	XX0011		Preset 3
	14 Preset 5 (In)	2	XX0010		Preset 2
	15 Preset 6 (In)	1	XX0001		Preset 1
	0	XX0000		Unused	
	N/A	101111	Preset 5	N/A	
	N/A	011111	Preset 6	N/A	

DVI Connector

The DVI connector can be used to output the instrument display to an external monitor. This is only available on the WVR products. The following table lists the signal characteristics of the connector.

Table 7: DVI connector specifications for the WVR products

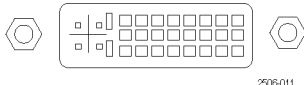
Connector	Characteristic	Description
 <p>DVI</p>	Output Connector	DVI DSUB
	Output Levels	Selectable for 0.7 V or 1 V for RGB signals; fixed 5 V for H and V sync signals

Ethernet Connector

Use the Ethernet connector to connect the instrument to your local network. A network connection is required for software upgrades and Web access instrument online help, diagnostics logs, event logs, and screen capture tools.

The following table lists the signal characteristics of the Ethernet connector.

Table 8: Ethernet connector pin assignments for the WFM and WVR products

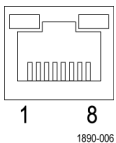
Connector	Pin/LED	Name	Description
			RJ-45 LAN supporting 10/100 BaseT; supports manual and DHCP address modes
	1	TX_D1+	Transceive Data+
	2	TX_D1-	Transceive Data-
	3	RX_D2+	Receive Data+
	4		Not used
	5		Not used
	6	RX_D2-	Receive Data-
	7		Not used
8		Not used	

Headphone Jack

Use the headphone jack, located on the front panel, to listen to the audio associated with the selected video input signal. The following table describes the signal characteristics of the headphone jack.

Table 9: Headphone jack specifications for the WFM and WVR products

Connector	Characteristic	Description
	Output Type	Standard 1/4-inch stereo phone jack, capable of driving a 6.25 dBu sine wave into 32 Ω or 16 Ω

USB Connector

Use the USB connector, located on the front panel, to save and restore instrument presets and captured data using a USB memory device. The following table describes the signal characteristics of the USB connector.

Table 10: USB connector specifications for the WFM and WVR products

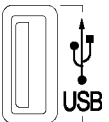
Connector	Characteristic	Description
	Type	Host
	Speed	Complies with USB 1.1 Full Speed Specification (12 Mb/s)

WFM4000 and WFM5000 Rackmount Installation

To install a WFM4000 or WFM5000 in a rack, you must use the WFM50F02 or WFM50F03 rack adapter kit. This rack is designed to house two half-rack instruments side-by-side in a rack.

To accommodate different products, three types of sleeves are available. See the instructions that come with the rack adapter kit for the proper sleeve combination for your instrument.

NOTE. *If you already have a WFM70F05, WFM50F03, or WFM50F02 rack and you would like to purchase sleeves only, contact the Tektronix Customer Service Center using the contact information in the front of this book. If you have one or more WFM4000 or WFM5000 instruments, you will want to purchase one or more of the WFM50F03-001 sleeves (437-0523-XX).*



CAUTION. *Be sure to use the correct sleeve for your product. If you use the wrong sleeve, it could damage the instrument and cause overheating problems.*

The ventilation holes and EMI shielding on the sleeves are specially designed to meet the requirements of the instruments for which they were intended.

The type of sleeve(s) included with the rack adapter kit is configured when you order the adapter. You can also install a sleeve in one side of the rack adapter and a blank panel (1700F06) or an utility drawer (075-0978-00) in the other side of the adapter to improve airflow and appearance.

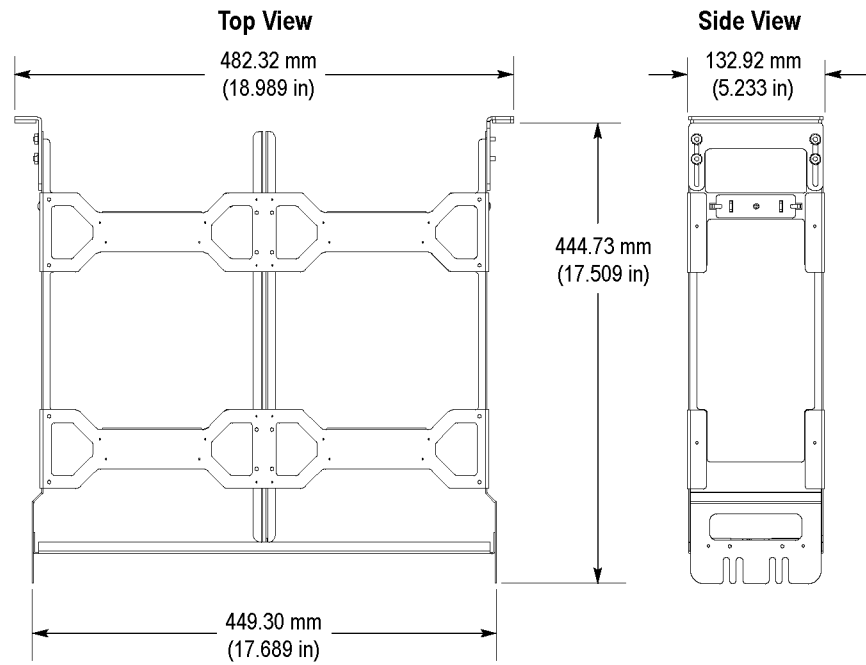

Figure 5: Rack adapter dimensions

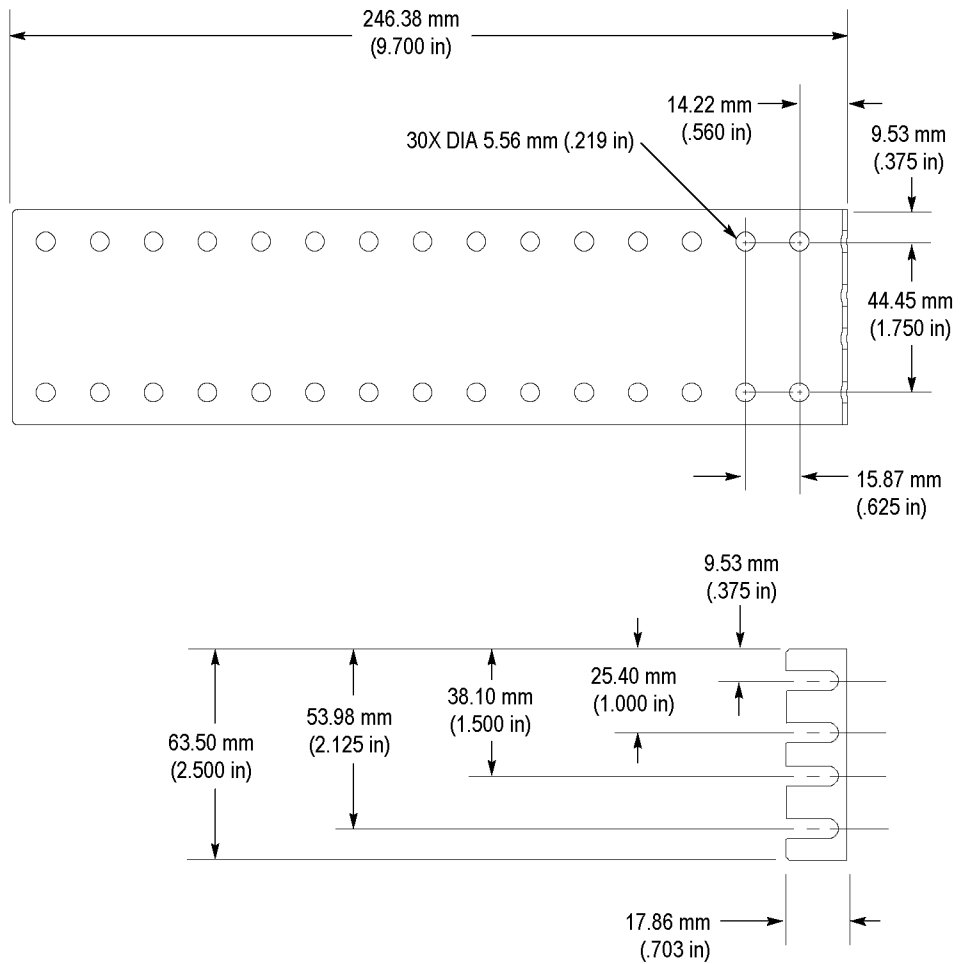

Figure 6: Rear bracket guide dimensions

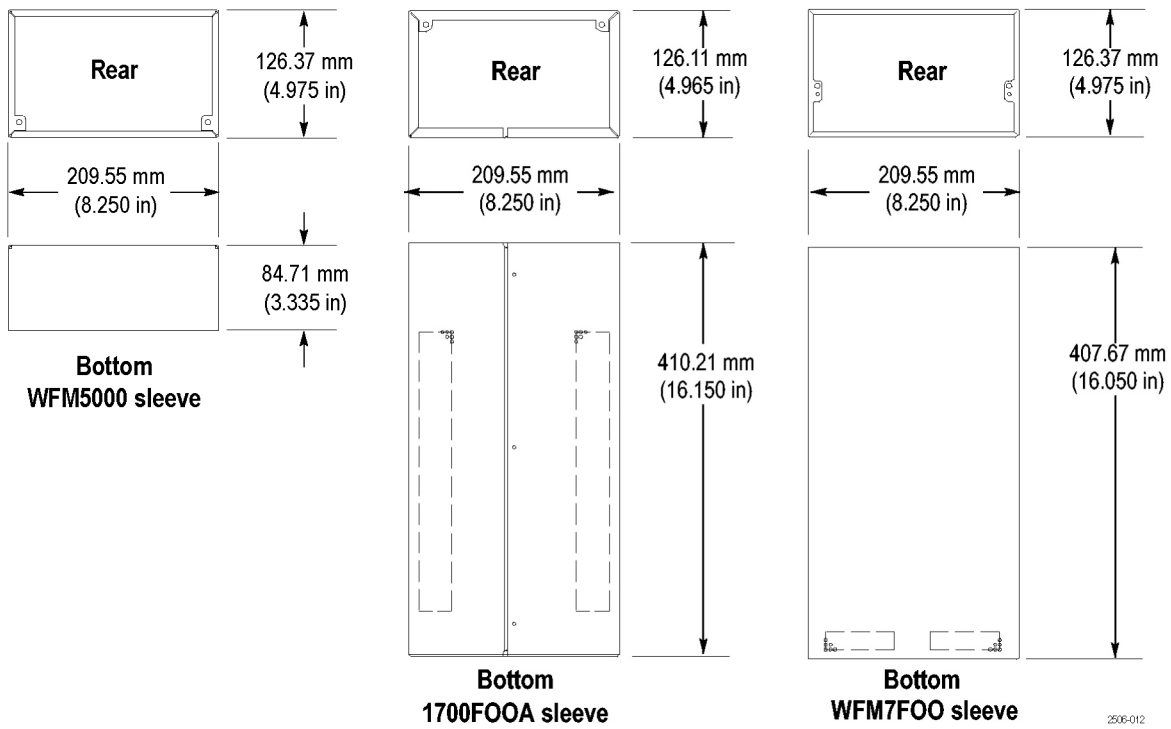

Figure 7: Sleeve dimensions

Before you install an instrument into the rack adapter, install the adapter into the rack as follows:

NOTE. *The numbers in brackets in the following procedure refer to the circled numbers in the figure and in the parts list.*

The rack adapter is marked with the word "TOP" to indicate which side of the adapter should face up. (See Figure 8.)

1. If the two sleeves are installed in the rack adapter, remove them as follows: locate the button on the inside front of the rack adapter and hold it in while pulling the sleeve forward and out of the adapter. (See Figure 8.)
2. If desired, you can adjust the position of the handle brackets to mount the adapter flush with other equipment in the rack. To do this, loosen the nuts that attach the handle brackets to the rack adapter, adjust the position of the handle brackets as desired, and then tighten the nuts securely. (See Figure 8.)
3. Secure the rack adapter assembly to the front frame of the rack using four screws and four shoulder washers.
4. Install one guide bracket to one side of the rear frame of the rack using the screws and nut bar provided in the kit.
5. Secure the guide bracket to the rack adapter, using the nut bar and attaching hardware. Use the holes in the bracket that will accommodate the depth of the instrument rack frame being used. Leave the screws loose.
6. Install the other guide bracket to the other side of the rear frame of the rack, using the screws and nut bar.
7. Secure the guide bracket to the rack adapter, using the nut bar and attaching hardware.
8. Tighten all attaching screws that were left loose in the previous steps.

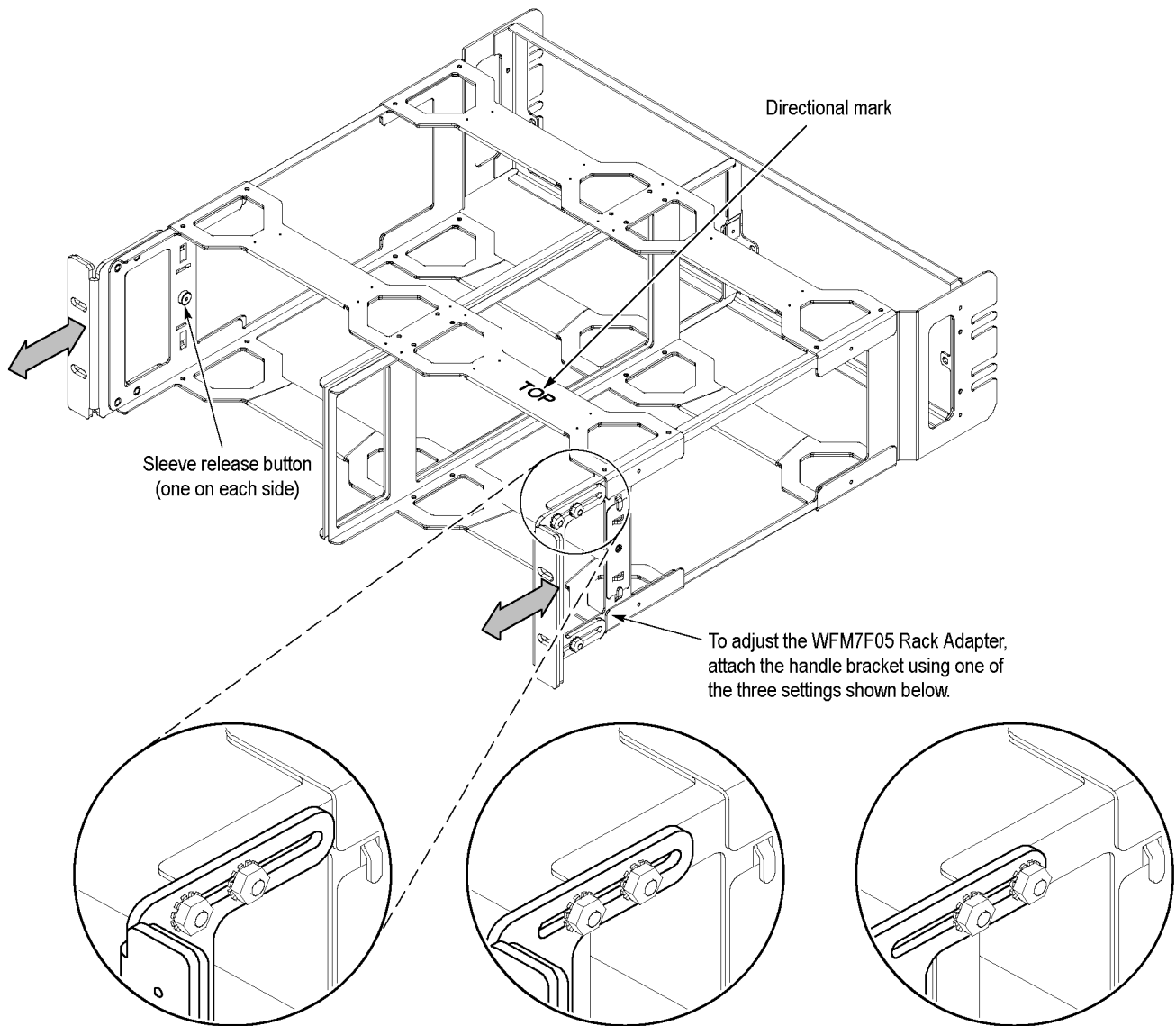

Figure 8: Adjusting the position of the handles

Installing a WFM4000 or WFM5000 into the Rack Adapter

With the rack adapter already installed in the rack, install the instrument into the rack adapter as follows:



CAUTION. *When working with instruments that are not enclosed in a chassis, you must observe static precautions. You must also be careful not to damage circuit board mounted components or interconnection wiring when sliding a sleeve over these products.*

1. Refer to the figure to choose the appropriate sleeve in which to install your instrument. (See Figure 9.)
 - The WFM7F00 sleeve (Tektronix part number 390-1210-XX) and the WFM50F03-001 sleeve (Tektronix part number 437-0523-XX) are designed for the WFM4000 and WFM5000. (See Figure 9.)
 - The 1700F00A sleeve (Tektronix part number 390-1211-XX) is designed for 1700 Series, WFM601 Series, older half rack instruments, 760A, and 764. The rear panel attaching tabs on this sleeve are closer to the top of the rear frame. (See Figure 9.)

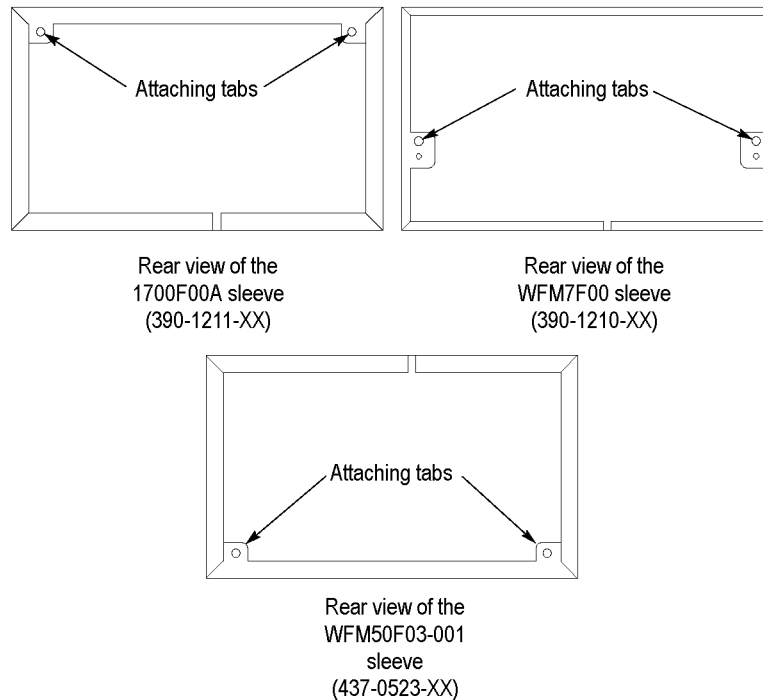

Figure 9: Rear view of three sleeves, showing the attaching tabs and screws



CAUTION. Be sure to use the correct sleeve for your product. If you use the wrong sleeve, it could damage the instrument and cause overheating problems.

The ventilation holes and EMI shielding on the sleeves are specially designed to meet the requirements of the instruments for which they were intended.

2. Slide the sleeve into the desired half of the rack adapter, depressing the button on the inside front of the rack adapter as needed to insert the sleeve. (See Figure 10.)

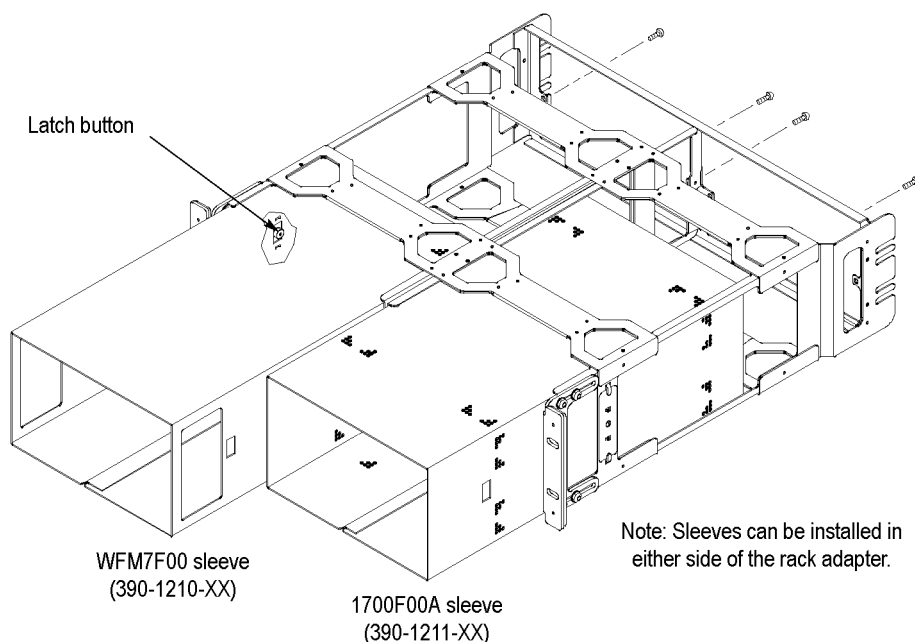

Figure 10: Installing the sleeves into the rack adapter. Only two sleeve types are shown in this example.



WARNING. During installation, the instrument could slide out of the sleeve and cause instrument damage or personal injury. To prevent the instrument from sliding out of the sleeve, be careful to hold the instrument until it is secured.

3. Make sure that the button pops back out and that it securely locks the sleeve in the rack adapter.



CAUTION. Do not force the instrument into the cabinet. Keying pins on the tabs at the rear of the sleeves are designed to work only with the correct instrument. Attempting to force an instrument into the sleeve may damage the tabs.

4. Slide the instrument into the sleeve. Be careful to keep the instrument from sliding out of the sleeve until you attach the screws in step 5.
5. On the rear panel, install and tighten the two attaching screws as follows:
 - For the WFM7F00 and WFM50F03-001, insert the screws through the rack adapter, through the tabs on the sleeve, and then into the instrument rear panel. (See Figure 9.)
 - For the 1700F00A, insert the screws through the holes on the top right and left of the sleeve and into the instrument rear panel. (See Figure 9.) The screws do not attach to the rack adapter; this sleeve is held in place by the button on the inside front of the rack adapter.

Network Operation for the WFM and WVR

This section provides information about using a local LAN network and Web browser to download instrument Error and Diagnostic log files, to access online help, or to capture images of the instrument display.

IP Settings Configuration

To allow network access to the instrument, you need to set the IP address. Network addresses can be assigned either automatically (DHCP) or manually. If your network does not use DHCP, you will have to manually enter the address for the instrument. To obtain a valid IP address, contact your LAN administrator.

Perform the following steps to configure the IP settings on the instrument:

1. Press the **CONFIG** button to display the Configuration menu.
2. Use the down arrow key or the General knob to navigate to **Network Settings**.
3. Press the right arrow to navigate to the **Network Settings** submenu.
4. Press the **SEL** button to select **Manual** or **DHCP** for the **IP Config Mode**. Which you choose depends on your network setup.
5. Press the down arrow key to navigate to **Web Enable** and press the **SEL** button to highlight **On**.

NOTE. *If you cannot use DHCP mode, you will have to set the Subnet Mask and Gateway Address parameters in this menu; contact your LAN administrator for required values. (Be sure to use compatible addresses between the PC and the instrument.)*

6. If you want to assign the instrument a name, navigate to **Instrument Name**.
7. Press the right arrow key and a box will appear that allows you to name the instrument using the arrow keys, General knob, and the **SEL** button. To begin, press the right arrow key until the cursor highlights the first box in the top row, then turn the General knob to change the letter or number.
8. When you are finished, press the **CONFIG** button to dismiss the Configuration menu.

Web Browser Operation

You can connect to an instrument installed on an Ethernet IP network without installing any software and using only a Web browser. Using the Web browser, you can perform the following functions:

- Download the Event log files
- Download the Diagnostic log files
- Capture images of the instrument display

Perform the following steps to connect to the instrument using a Web browser:

1. Verify that the instrument has been configured for IP network operation and is Web enabled. (See page 21, *IP Settings Configuration*.)
2. On your PC, start your Web browser and enter the network address of the instrument into the URL entry box like this:

`http://123.123.123.123/`

NOTE. *Many Web browsers do not correctly interpret IP addresses with leading zeros. If the IP address shown in the Configuration menu contains leading zeros, remove any leading zeros when you enter the address in the browser.*

For example, the IP address 124.161.038.092 should be entered as follows:

124.161.38.92

3. The Web browser will display the instrument Web page. To make a selection, click the desired link.